

T'20 Objects, Stories
cat. Sofas,
Modular Systems

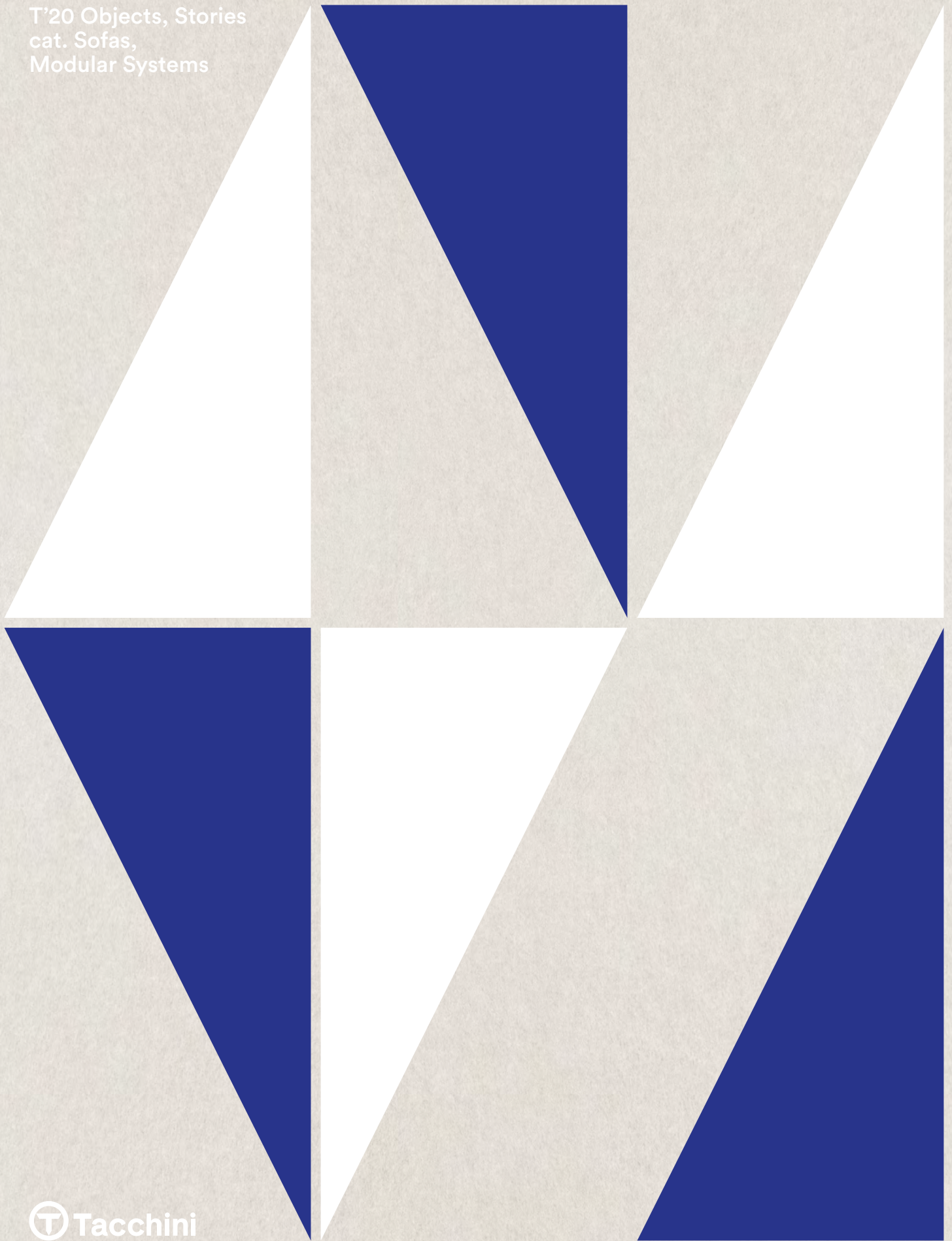

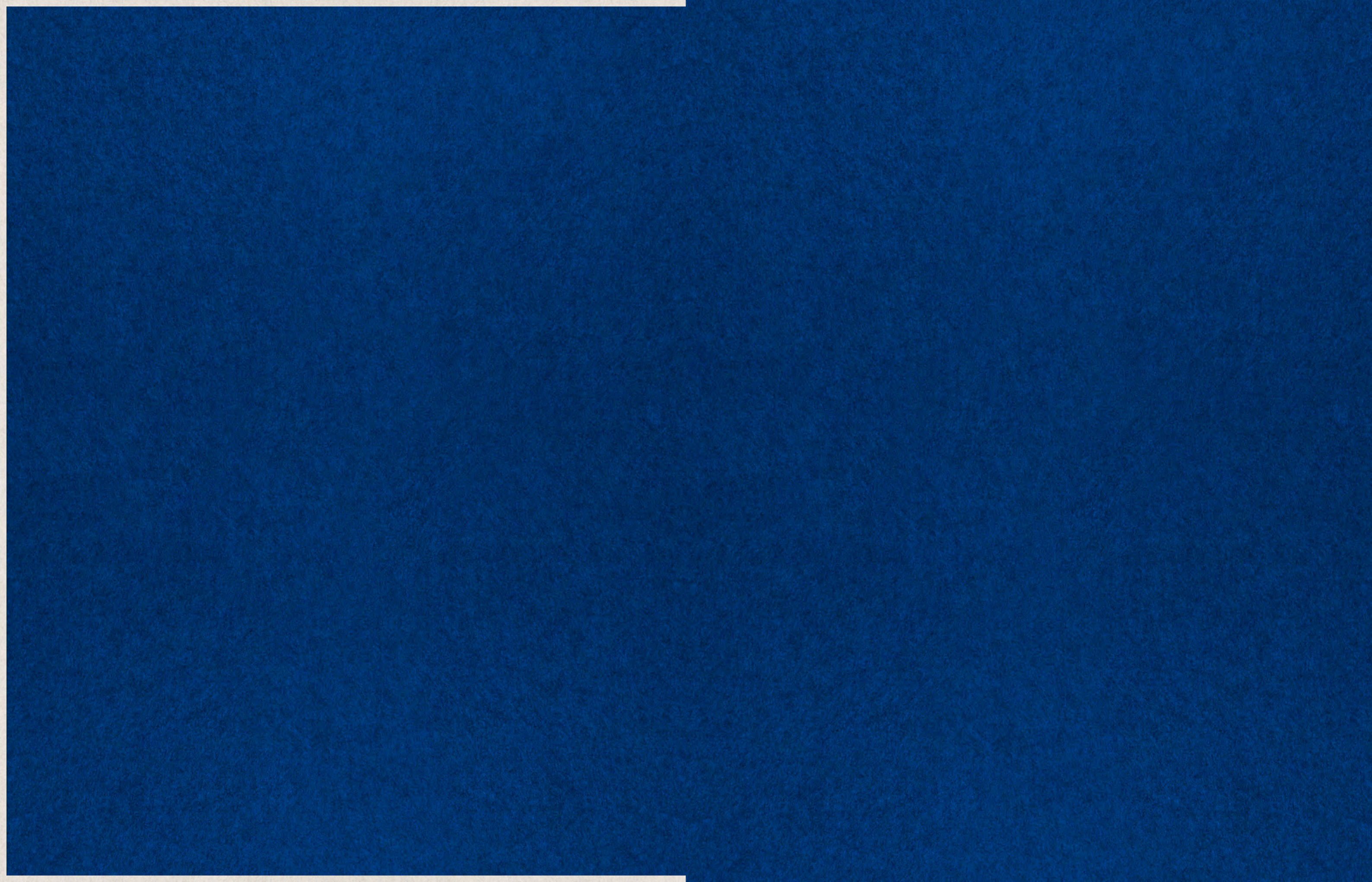

Object, Stories

T'20 Vol. A

Objects,

Immagini che raccontano momenti discreti, quasi intimi: le segrete stanze sono svelate, così come i loro abitanti. La grande casa Tacchini apre le sue porte, e mostra attimi rubati da una quotidianità che è fatta di cura e attenzione, per i materiali e gli strumenti: ma anche per gli uomini che li maneggiano con passione. Un luogo dove ognuno ha un ruolo e tutti sono parte di un'unica storia.

Stories

Ci sono storie che si raccontano nell'immediatezza di un oggetto: i materiali addomesticati rivelano le mani che l'hanno plasmato, la forma suggerisce l'innovazione della tecnologia e la cultura dell'esperienza, mentre la funzione svela la poesia del *beau geste* progettuale. E la storia di un'azienda di design si racconta in ognuno dei capitoli che compone la sua produzione: come istantanee preziose di un lungo racconto, da scrivere ancora. Ogni progetto è il punto di tangenza tra esperienza e ricerca, passione e sentimento, arricchiti poi dal trascorrere del tempo nei luoghi dell'abitare, dove ognuno di noi interagisce con il proprio vissuto: in una staffetta continua tra presente e memoria.

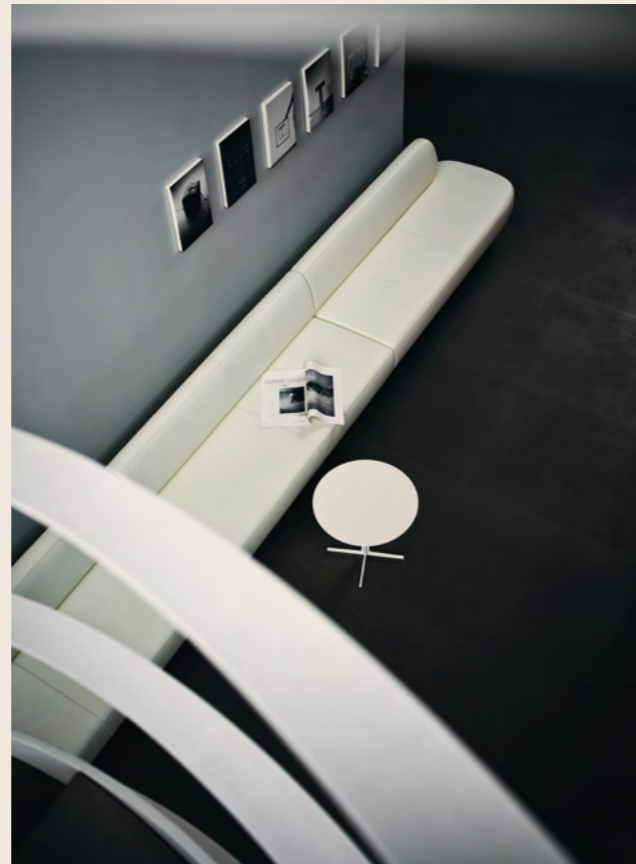

Images that speak of discreet, almost intimate moments: the secret rooms are revealed, as are their inhabitants. The great Tacchini house opens its doors, exposing instants stolen from an everyday life built on care and attention for materials and tools, but also for the people that handle them with such dedication. A place where everyone has a role, and everyone is part of a unique story.

There are stories that are told through the immediacy of an object: domesticated materials speak of the hands that have shaped them, the shape suggests technological innovation and a culture of experience, while the function reveals the poetry of the design's *beau geste*. And the story of a design company is narrated in each of the chapters of its production, like precious snapshots of a long tale still to be written. Each project is the meeting point between experience and research, devotion and emotion, then enriched by passing time in the places where we live, where each of us interacts with our own experiences, in an ongoing relay between present and memory.



Design Being

Tacchini è un luogo dove le mani sono il primo tra gli strumenti che hanno imparato a valorizzare, e che continuano a impiegare per riconoscere il pregio e valore dei materiali, per poi trasformarli, cucirli, e accostarli tra loro: procedendo secondo un ritmo di gesti sapienti e antichi, ripercorrendo, e migliorando ogni volta, la storia e la memoria. Fare le cose a mano significa stabilire un rapporto preciso tra oggetto e creatore, una trasmissionza, percepibile e visibile, di sensibilità e rispetto: e che si rivelerà anche a colui che possiederà quel manufatto. Una sorta di staffetta continua tra quanto le nostre dita riconoscono, nelle pieghe di una pelle o nella curva di un telaio, e le mani stesse che hanno reso possibile quelle forme.



Una storia di famiglia

Il design è italiano, il resto è produzione. E in Italia, le aziende di design portano il nome delle famiglie che ne hanno fondato il marchio. Come Tacchini, creata nel 1967 da Antonio: quando anche la produzione era quasi esclusivamente italiana, e sono stati scritti i brani più poetici e entusiasmanti della storia del design. Naturale che i figli diventino poi gli eredi, e ogni volta fondatori, secondo una logica di continuo aggiornamento e rielaborazione di un pensiero: ciò che viene realmente tramandato. Così come è naturale che chi frequenta questa famiglia ne diventi parte: collaboratori, consulenti, fornitori, dipendenti, maestranze, clienti. Ancora oggi, in questa famiglia, la forza dell'idea è al centro di ogni momento creativo, in un normale evolversi: dall'astrazione del pensiero alla tridimensionalità dell'oggetto, per poi diventare l'essenza dell'abitare. Questo procedere costante garantisce il legame con la contemporaneità, valorizzato poi dalla scelta di materiali di qualità e tecnologie

Objects, Stories



sempre aggiornate e sempre riferite a una tradizione da non perdere: evitando così la possibilità di confondere lo stile con le mode e il design con la semplice produzione di serie. Inevitabile che la storia di una famiglia si rifletta poi nei luoghi che essa abita: la sede di un'azienda è lo specchio delle persone che ci lavorano e della filosofia a cui esse si ispirano. La casa di Tacchini è un'architettura mossa su due livelli, incrocio di materiali e spazi che si fondono in un unico luogo di pensiero e sintesi dello stesso. Sullo sfondo, la Brianza, tra Como e Milano, troppo verde e accecante in estate e troppo grigia e intimista in inverno: questi luoghi, così estremi, diventano lo sfondo di questa storia, autentica culla del design, dove gli uomini e le idee si fondono nella cultura del progetto. Ogni oggetto, ciascun arredo che provenga da questa casa, porta con sé l'imprinting del design italiano: capace di rendere luogo qualsiasi spazio, sia esso pubblico o privato, domestico o collettivo, e riempiendolo dell'esserci.

Design Being

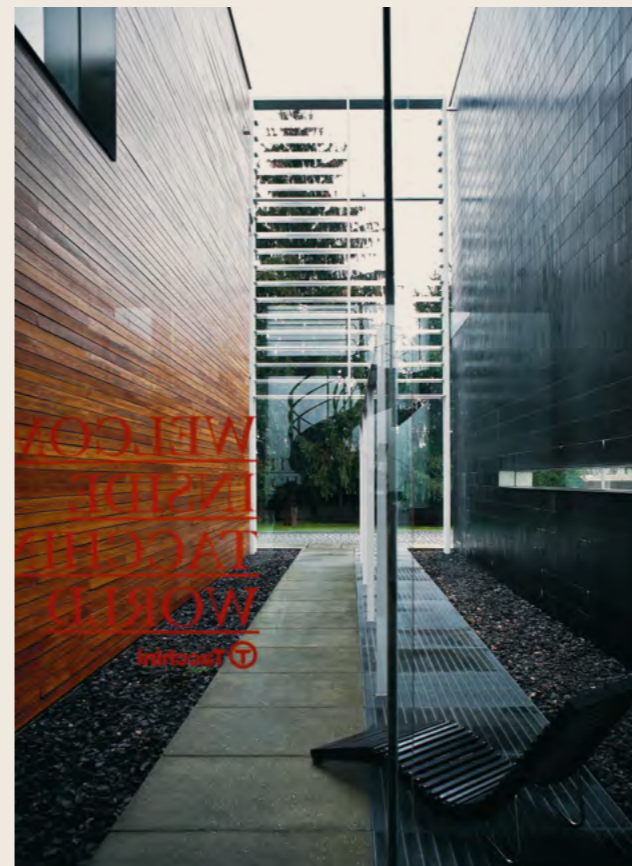

Objects, Stories

At Tacchini, hands were the first tool they learnt to harness, and they continue to use them to discern the quality and value of the materials, before transforming them, sewing them and combining them together: following ancient, knowing rhythms, retracing and honing history and memory. Doing things by hand means establishing a precise relationship between the object and its creator, a perceptible, visible transmittance of sensitivity and respect: and all this will be palpable to the person who ultimately possesses the item in question. A kind of ongoing relay between what our fingers can detect, in the folds of a piece of leather or in the curve of a frame, and the actual hands that have made those shapes possible.

A family history

The design is Italian, the rest is production. And in Italy, design companies bear the names of the families that founded the brands. Like Tacchini, created in 1967 by Antonio, when production, too, was almost entirely Italian, and the most poetic and soul-stirring passages in the story of design were written. Naturally in time the children become the heirs, and the new founders, in a rationale of continuous updating and redefinition of the underlying idea, and that is what is actually handed down. Equally naturally, those who frequent the family become a part of it: team members, consultants, suppliers, employees, workers and clients. Still today, in this family, the strength of the idea is central to every creative process, in a logical process of evolution, from the analysis of the idea to the three dimensions of the object, before ultimately becoming the essence of living. This ongoing process ensures a sense of connection with contemporary style, which is then further enhanced by the choice of quality materials and leading-edge technology, and always referencing an all-important tradition, so as to avoid the danger of confusing style with fleeting fashions and design with simple mass production. Inevitably, the story of a family is reflected in the places they inhabit: the headquarters of a company mirrors the people who work there and the philosophy to which they aspire. The Tacchini building features an architecture structured into two storeys, a fusion of materials and spaces that blend into a complete whole, expressing its ethos and essence. In the background, Brianza, between Como and Milan, too blindingly green in summer, too grey and inward-looking in winter; these places with their extremes form the backdrop to this story, the very birthplace of design, where people and ideas merge with the design culture. Each object, each piece of furniture created in this building carries within it the hallmark of Italian design: the ability to give any space a sense of place, be it public or private, domestic or communal, filling it with presence.

Bei Tacchini sind die Hände das erste Werkzeug, das wir gelernt haben, uns nutzbar zu machen, und die weiterhin eingesetzt werden, um die Güte und den Wert von Materialien zu erkennen, sie zu verwandeln, zusammenzunähen und miteinander zu verbinden: das alles im Rhythmus weiser, althergebrachter Gesten, die Geschichte und Erinnerung durchlaufen und immer noch besser werden. Etwas mit den Händen zu schaffen, stellt eine klare

Beziehung zwischen dem Gegenstand und seinem Schöpfer her und vermittelt – wahrnehmbar und sichtbar – ein Gefühl der Sensibilität und Achtung: dieses Gefühl teilt sich auch dem Besitzer des Gegenstandes mit. Wie ein ständiger Staffellauf zwischen dem, was unsere Finger in den Falten des Leders oder der Biegung eines Gestells erkennen, und den Händen, die diese Formen ermöglichen haben.

Eine Familiengeschichte

Es gibt Geschichten, die von einem Gegenstand spontan erzählt werden: die gezähmten Materialien weisen auf die Hände hin, die sie geformt haben, die Form deutet den innovativen technischen Inhalt und die Kultur der Erfahrung an, während die Funktion die Poesie des kreativen Entwurfs erkennen lässt. Und die Geschichte einer Designerfirma erzählt sich in jedem Kapitel, aus dem sich ihre Produktion zusammensetzt: wie wunderbare Momentaufnahmen einer langen Erzählung, die weiter fortgesetzt wird. Bei jedem Entwurf treffen Erfahrung und Experiment, Leidenschaft und Gefühl zusammen, bereichert durch das Verstreichen der Zeit in der häuslichen Umgebung, die stets eine interaktive Beziehung zu unserem Leben herstellt: in einem kontinuierlichen Staffellauf von Vergangenheit und Erinnerung. Das Design ist italienisch, der Rest ist Produktion. In Italien tragen Designerfirmen den Namen der Familien, die sie gegründet haben. Wie Tacchini, der 1967 von Antonio ins Leben gerufene Betrieb: als auch die Produktion noch fast ausschließlich italienisch war und Poesie und Enthusiasmus die Geschichte von Design geprägt haben. Natürlich geht das Erbe auf die Söhne über, die das Bestehende immer wieder aktualisieren und neu bearbeiten und ihrerseits das begründen, was tatsächlich weitergegeben wird. Ebenso natürlich gehören bald alle zur Familie, die mit ihr zu tun haben: Mitarbeiter, Berater, Lieferanten, die ganze Belegschaft, Kunden. Auch heute noch steht in dieser Familie die Kraft der Ideen in einer normalen Entwicklung im Mittelpunkt jeder Kreativität: von der Abstraktion des Gedankens zur dreidimensionalen Größe eines Gegenstandes, der dann zum wesentlichen Bestandteil unserer Wohnwelt wird. Dieser kontinuierliche Prozess sorgt für den zeitgemäßen Charakter, der durch hochwertige Materialien und modernste Technik noch betont wird, ohne eine Tradition zu verlieren, die unverzichtbar ist: um nicht Stil mit Mode zu verwechseln und Design mit einer einfachen Serienproduktion. Unvermeidbar, dass sich die Geschichte einer Familie auch in den von ihr bewohnten Orten widerspiegelt: der Sitz eines Unternehmens ist der Spiegel der dort arbeitenden Menschen und der Philosophie, von der sie sich leiten lassen. Das Haus von Tacchini ist eine lebendige Architektur auf zwei Ebenen, eine Kreuzung aus Materialien und Räumen, die zu einem einzigen Ort der Gedanken und ihrer Synthese verschmelzen. Im Hintergrund die Brianza, die Region zwischen Como und Mailand, zu grün und zu blendend im Sommer, zu grau und zu intim im Winter: diese Orte der Extreme werden zur Kulisse dieser Geschichte, authentische Wiege des Designs, wo Menschen und Ideen in der Kultur der Entwürfe verschmelzen. Jeder Gegenstand, jedes Möbel aus diesem Hause ist von Design imitalienischen Stil geprägt: damit jeder Raum, ob öffentlich oder privat, häuslich oder kollektiv, zu einem lebendigen Ort werden kann.

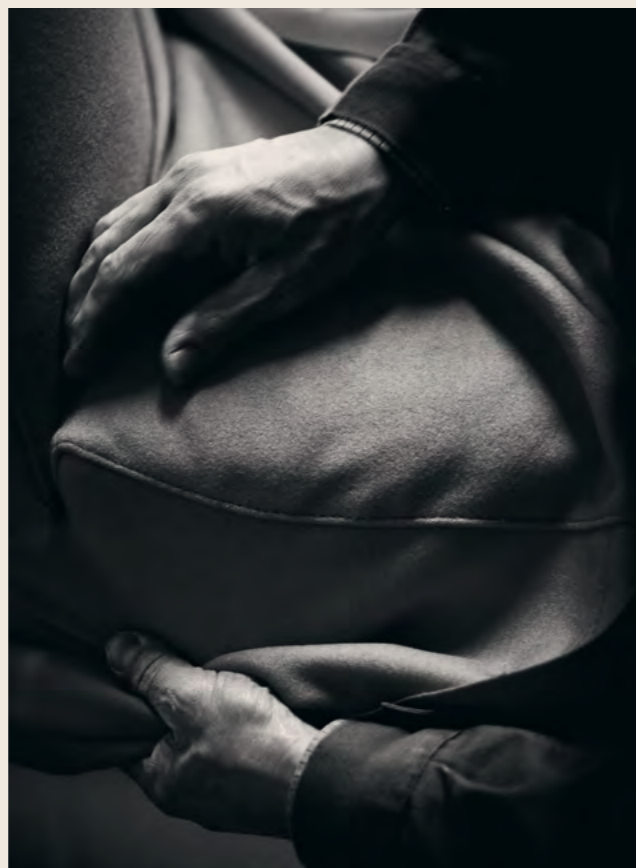

Tacchini est un endroit où les mains sont le premier des outils qu'ils ont appris à mettre en valeur et qu'ils continuent à utiliser pour reconnaître la qualité et la valeur des matériaux, pour ensuite les transformer, les coudre et les marier entre eux : procédant selon un rythme de gestes savants d'antan, en refaisant le parcours de l'histoire et de la mémoire tout en l'améliorant à chaque fois. Faire les

choses à la main signifie établir un rapport précis entre l'objet et son créateur, une transmission, perceptible et visible, de sensibilité et de respect, qui se révélera aussi à la personne qui possédera cet article fait main. Une sorte de relais continu entre ce que nos doigts reconnaissent, dans les plis d'une peau ou dans la courbe d'un châssis, et les mains qui ont rendu ces formes possibles.

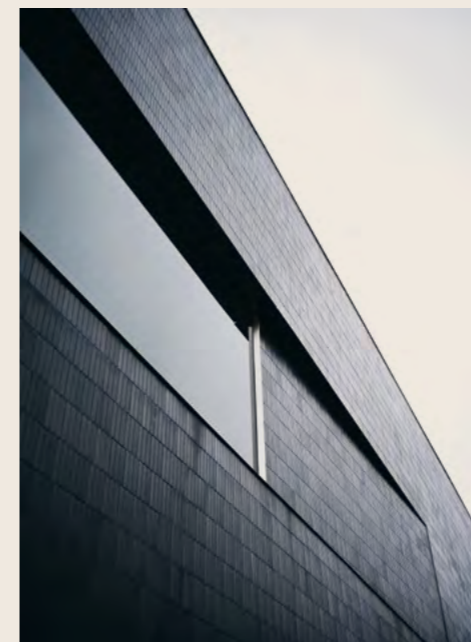

Une histoire de famille

Il y a des histoires qui se racontent dans l'imédiateté d'un objet : les matériaux apprivoisés révelent les mains qui les ont modelés, la forme suggère l'innovation de la technologie et la culture de l'expérience, tandis que la fonction dévoile la poésie et la beauté du geste conceptuel. Et l'histoire d'une entreprise de design se raconte dans chacun des chapitres qui composent sa production : comme des instantanés précieux d'un long récit qui reste à écrire. Chaque projet est le point de rencontre entre l'expérience et la recherche, la passion et le sentiment, enrichis par l'écoulement du temps dans les espaces intimes, où chacun de nous interagit avec son vécu, dans une alternance continue entre présent et mémoire. Le design est italien, le reste est production. Et en Italie, les éditeurs de design portent le nom des familles qui en ont créé la marque. Comme Tacchini, créée en 1967 par Antonio, quand la production aussi était exclusivement italienne, et qu'ont été écrites les pages les plus poétiques et enthousiasmantes de l'histoire du design. Il est naturel que les enfants en héritent et se transforment parfois eux-mêmes en fondateurs, suivant une logique de mise à jour et réélaboration perpétuelle d'une pensée : ce qui est réellement transmis. Tout comme il est naturel que ceux qui fréquentent cette famille en fassent partie : collaborateurs, consultants, fournisseurs, salariés, ouvriers, clients. Aujourd'hui encore,

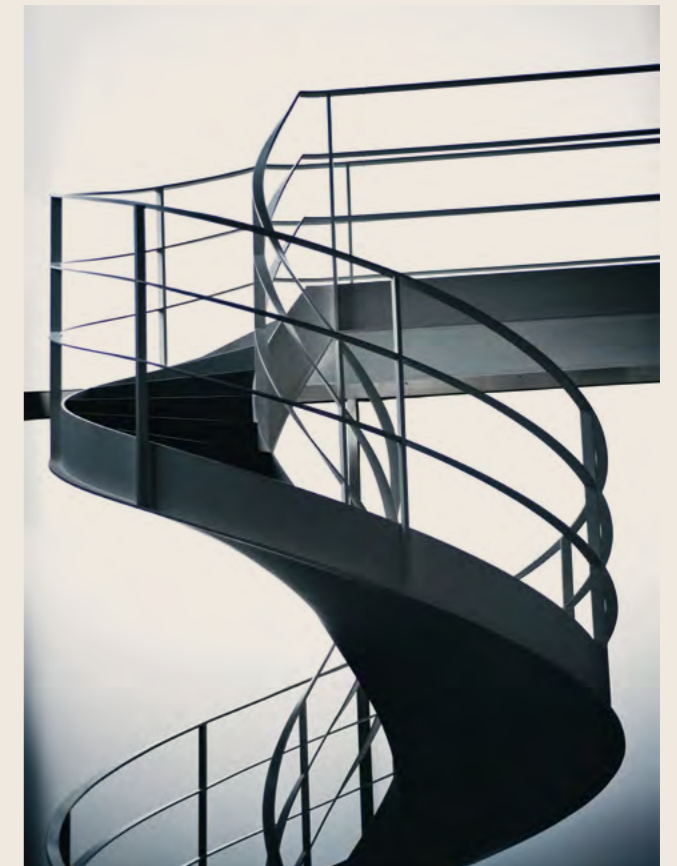

dans cette famille, la force de l'idée est au cœur de chaque moment créatif, dans une évolution logique : de l'abstraction de la pensée à la tridimensionnalité de l'objet, pour devenir en suite l'essence de l'habitat. Cette progression constante garantit le lien avec le contemporain, valorisé par le choix de matériaux de qualité et de technologies sans cesse améliorées et ayant toujours à l'esprit la tradition à préserver, en évitant ainsi la possibilité de confondre le style avec les modes et le design avec la simple production en série. Il est inévitable que l'histoire d'une famille se reflète dans les lieux qu'elle habite. Le siège d'une entreprise est ainsi le miroir des personnes qui y travaillent et de la philosophie à laquelle elles s'inspirent. La maison de Tacchini est une architecture élaborée sur deux niveaux, croisement de matériaux et d'espaces qui se fondent en un lieu unique de pensée et en sont la synthèse. En décor de fond, la Brianza, entre Côme et Milan, trop verte et éblouissante en été et trop grise et intimiste en hiver: ces lieux, si extrêmes, deviennent le cadre de cette histoire, authentique berceau du design, où les hommes et les idées se fondent dans la culture du projet. Chaque objet, chaque meuble qui provient de cette maison, porte avec lui l'imprinting du design italien : capable de faire de chaque espace un lieu, qu'il s'agisse d'une structure publique ou privée, domestique ou collective, en le remplissant du seul fait d'y être.

Sofas

| | | | | |
|-----|--------------|------------------------|--------------------------------------------|--------------------|
| 098 | Crystal | PearsonLloyd | Sofa, Armchair ↪ Vol. B | Contract |
| 092 | Dressed | Luca Nichetto | Sofa | Domestic, Contract |
| 044 | Face to Face | Gordon Guillaumier | Sofa | Domestic, Contract |
| 118 | Havana | Lievore Altherr Molina | Sofa, Sofa Bed | Domestic, Contract |
| 010 | Julep | Jonas Wagell | Sofa, Armchair, Ottoman, Chaise-longue | Domestic, Contract |
| 104 | Labanca | Lievore Altherr Molina | Sofa, Armchair | Contract |
| 078 | Lima | Claesson Koivisto Rune | Sofa, Armchair, Ottoman | Domestic, Contract |
| 056 | Montevideo | Claesson Koivisto Rune | Sofa, Armchair, Ottoman, Chair ↪ Vol. B | Domestic, Contract |
| 050 | Oliver | Gianfranco Frattini | Sofa | Domestic, Contract |
| 084 | Quadro | Pietro Arosio | Sofa, Armchair, Ottoman | Domestic, Contract |
| 062 | Quilt | PearsonLloyd | Sofa, Armchair, Ottoman | Domestic, Contract |
| 036 | Roma | Jonas Wagell | Sofa, Armchair | Domestic, Contract |
| 070 | Santiago | Claesson Koivisto Rune | Sofa, Armchair, Ottoman | Domestic, Contract |
| 018 | Sella | Carlo De Carli | Sofa, Armchair | Domestic, Contract |
| 026 | Sesann | Gianfranco Frattini | Sofa, Armchair ↪ Vol. B | Domestic, Contract |
| 112 | Sliding | Pietro Arosio | Sofa, Sofa Bed | Domestic, Contract |

Modular System

| | | | | |
|-----|----------------|--------------------|--------------------------------------|----------|
| 132 | Chill-Out | Gordon Guillaumier | Modular System | Contract |
| 140 | Chill-Out High | Gordon Guillaumier | Modular System | Contract |
| 148 | Galleria | PearsonLloyd | Modular System | Contract |
| 190 | Intercity | Pietro Arosio | Modular System, Ottoman | Contract |
| 124 | Ischia | PearsonLloyd | Modular System, Screen | Contract |
| 162 | Polar | PearsonLloyd | Modular System, Armchair, Ottoman | Contract |
| 170 | Polar Perch | PearsonLloyd | Modular System | Contract |
| 180 | Stone High/Low | PearsonLloyd | Modular System | Contract |

Technical informations

Sofas

| | |
|-----|--------------|
| 201 | Crystal |
| 201 | Dressed |
| 201 | Face to Face |
| 202 | Havana |
| 202 | Julep |
| 202 | Labanca |
| 203 | Lima |
| 203 | Montevideo |
| 203 | Oliver |
| 204 | Quadro |
| 204 | Quilt |
| 205 | Roma |
| 205 | Santiago |
| 205 | Sella |
| 206 | Sesann |
| 206 | Sliding |

Modular Systems

| | |
|-----|--------------------------|
| 207 | Chill-Out |
| 207 | Chill-Out High Back/Arms |
| 208 | Chill-Out High |
| 209 | Galleria |
| 210 | Intercity |
| 212 | Ischia |
| 213 | Polar |
| 213 | Polar Perch |
| 213 | Stone High/Low |

Object, Stories

Vol. A, Catalogue

Domestic, Contract

Sofa, Armchair, Ottoman, Chaise-longue

Julep

Famiglia di imbottiti dalle forme morbide e avvolgenti, Julep è ispirata all'Avant-Garde anni Cinquanta, di cui recupera la semplicità e l'imponenza, ingentilite da un'allure contemporanea, romantica e femminile.

Informazioni → p.017



Protagonista della serie è il divano, dal cui segno rotondo e generoso si è via via sviluppata l'intera collezione – composta da poltrona, chaise-longue e pouf – in un gioco di proporzioni e volumi che ha dato vita, a poco a poco, a tutte le varianti. Completamente imbottite, le sedute hanno un aspetto pieno e abbondante, e tuttavia leggero, grazie alla base rientrante che le solleva invisibilmente da terra. Per il loro aspetto confortevole che invita all'intimità e al riposo, le sedute di Julep sono pensate per gli spazi domestici e perfette negli ambienti del contract.

Awards: 2018 Muuz International Awards,
2018 Archiproducts Design Awards

Designer, Year:
Jonas Wagell, 2019



Julep (Sofa)
W 240 D 126 H 75 cm
H seat 42 cm

→ Tacchini Edizioni: Narciso
(Rug) designed by Umberto
Riva, Mantiqueira (Vase) designed
by Domingos Tótor



Julep (Sofa)
W 240 D 126 H 75 cm
H seat 42 cm

Julep (Armchair)
W 102,5 D 87,5 H 75 cm
H seat 42 cm

Julep

Joaquim (Low Table)
top T119 Elegant Brown Marble,
base T27 Matt Black
Chrome ↗ Vol. B p.282

↗ Tacchini Edizioni:
Rituale (Rug) designed
by Umberto Riva

Julep (Sofa)
W 240 D 126 H 75 cm
H seat 42 cm

Julep (Armchair)
W 102,5 D 87,5 H 75 cm
H seat 42 cm

Soap (Low Table), top T118
Shiny Patagonia Marble,
base T25 Matt Champagne
Gold ⇨ Vol. B p.290



⇨ Tacchini Edizioni:
Rituale (Rug) designed
by Umberto Riva



Julep (Chaise-longue)
W 174 D 137 H 75 cm
H seat 42 cm

Soap (Low Table), top T31
White Calacatta Marble,
base T25 Matt Champagne
Gold ⇨ Vol. B p.290

Julep

En Soft, envelopping shapes characterize this family of upholstered pieces. Julep is influenced by the 1950s Avant-Garde movement, drawing upon its simplicity and grandeur, refined by a contemporary, romantic, feminine allure. Star of the series is the sofa, whose generous rounded lines provided evolutionary DNA for the entire collection – including an armchair, a chaise-longue and an ottoman – in an interplay of proportions and shapes that gave rise, little by little, to all the other versions. Fully upholstered, the seats look ample and full, yet convey a sense of lightness, thanks to the recessed base that invisibly lifts them off the floor. Designed for home decor, their inviting appeal encourages cozy comfort and relaxation, making the Julep seating options also ideally suited to contract venues.

De Julep ist eine Familie von Polstermöbeln in weichen, anschmiegsamen Formen, einfach und wuchtig nach dem Muster der Avantgarde der 1950er Jahre, aber verfeinert durch ein zeitgenössisches, romantisch-weibliches Flair. Im Blickpunkt der Linie das Sofa: Aus seinen runden, großzügigen Formen hat sich die ganze Kollektion – Lehnssessel, Chaiselongue und Hocker – entwickelt, die im Spiel mit Proportionen und Volumen allmählich alle Varianten entstehen ließ. Die komplett gepolsterten Sitzmöbel sind voll und üppig in der Optik, aber dank der zurückspringenden Basis dennoch leicht und wie über dem Boden schwebend. Sitzmöbel Julep, mit dem komfortablen Aussehen eine Einladung zu vertraulichen Gesprächen und zur Entspannung, sind für das häusliche Ambiente bestimmt, aber passen ebenso perfekt in den Objektbereich.

Fr Famille de sièges rembourrés aux formes douces et enveloppantes, Julep s'inspire de l'avant-garde des années cinquante, dont elle récupère la simplicité et les volumes imposants tempérés par une allure contemporaine, romantique et féminine. Le protagoniste de la série est le canapé. À partir de son signe rond et généreux s'est peu à peu développée toute la collection – composée de fauteuil, chaise-longue et pouf – dans un jeu de proportions et de volumes qui a donné vie à toutes les variantes. Complètement rembourrés, les sièges ont un aspect plein et abondant, et toutefois léger, grâce à la base en retrait qui les soulève invisiblement du sol. Avec leur aspect confortable qui invite à l'intimité et au repos, les éléments de la série Julep sont pensés pour les intérieurs domestiques et parfaits dans les espaces collectifs.



Jonas Wagell

Jonas Wagell is an architect and designer from Stockholm. Born in 1973, he trained as graphic artist and then specialised as an interior designer in Stockholm and New York, where he attended the Parsons School of Design. In 2008 he founded the JWDA firm which handles architecture, product design and brand management projects. Wagell is fond of creating functional items with features of simplicity and intelligence, objects which can be used and understood easily by those who choose them.

Other products by Jonas Wagell:
Roma ⇨ p.036

Technical informations



Sofa ⇨ p.202



Armchair ⇨ p.202

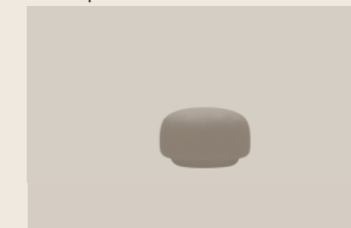

Ottoman ⇨ p.202



Chaise-longue ⇨ p.202

Domestic, Contract

Sofa, Armchair

Sella

Testimone del concetto di “spazio primario” della filosofia di De Carli, ovvero dello “spazio di relazione”, principi che trovano conferma nella visione della funzione d’arredo e della progettualità di interni secondo Tacchini, Sella è ispirato all’omonima poltrona disegnata nel 1966 dal celebre architetto italiano.

Informazioni → p.025



Il divano si presenta come un arredo di grande eleganza, realizzato con materiali di assoluto pregio: legno di noce a vista, dettagli in elegante metallo cromato finitura nera lucido e cinghie di supporto dello schienale in raffinato cuoio. Le cuscinate sono in pium e i rivestimenti possono essere in pelle, tessuto o velluto. La sua linea morbida e generosa è estremamente raffinata ed è progettata per regalare un comfort straordinario, dedicato a un tempo lento, che riconcilia con se stessi e con gli altri, nella dimensione di uno spazio di relazione più intimo e privato.

Designer, Year:
Carlo De Carli, (1966) 2019



Sella (Sofa), base T116
Canaletto Walnut
W 222 D 97 H 83 H seat 42 cm

→ Tacchini Edizioni:
Narciso (Rug)
designed by Umberto Riva



Sella (Sofa), base T116
Canaletto Walnut
W 222 D 97 H 83 H seat 42 cm

Joaquim (Low Table), top T119
Elegant Brown Marble,
base T27 Matt Black Chrome
⇒ Vol. B p.282

Sella

Quartier (Ottoman)
⇒ Vol. B p.176

⇒ Tacchini Edizioni: Narciso (Rug)
designed by Umberto Riva, Bubble (Vase)
designed by Alvino Bagni, Tarsia
(Tray) designed by Maria Gabriella Zecca





Sella (Armchair), base T116
Canaletto Walnut
W 102 D 97 H 83 H seat 42 cm

↳ Tacchini Edizioni:
Narciso (Rug)
designed by Umberto Riva

Sella

Design Classic ↗ Vol. B p.002
Discover Tacchini
process of re-editions

Sella illustrates the concept of "primary space" from De Carli's philosophy – that of a "relational space" –, a principle true to Tacchini's vision of the function of furniture and interior design.

En Sella is inspired by the armchair of the same name designed in 1966 by the famous Italian architect. The highly elegant sofa is made using the very finest of materials: exposed walnut, elegant metal chromed details finish shiny black and belts for the support of the backrest in refined natural leather. The cushions are filled with feathers, and the coverings could be in leather, fabric or velvet. Its soft, generous line offers the utmost refinement, and is designed to guarantee extraordinary comfort, conducive to a slow tempo that will reconcile us with ourselves and others, in a more intimate and private spatial dimension.

De Sella inspiriert sich am gleichnamigen Sessel, den der berühmte italienische Architekt Carlo De Carli im Jahr 1966 entworfen hat. Das Sofa präsentiert sich mit großer Eleganz und ist aus hochwertigen Materialien gefertigt: Nussbaumholz in Sicht, elegante Details aus verchromtem Metall mit Oberfläche in Glanzschwarz und Riemen zur Unterstützung der Rückenlehne aus exklusivem Leder. Die Kissen mit Federfüllung sind mit Bezug aus Leder, Stoff oder Samt erhältlich. Das Sofa überzeugt mit seinen weichen und großzügigen Formen, die ihm eine extreme Eleganz verleihen, und bietet herausragenden Komfort für entspannte Momente alleine oder mit Freunden in einem intimen und privaten Ambiente.

Fr Sella s'inspire du fauteuil du même nom, dessiné en 1966 par le célèbre architecte italien Carlo De Carli. Caractérisé par une grande élégance, le canapé est réalisé avec des matériaux haut de gamme : bois de noyer apparent, détails en élégant métal chromé finition noir brillant et sangles soutenant le dossier en cuir raffiné. Les coussins sont en plume et les revêtements disponibles en cuir, tissu ou velours. Sa ligne douce et généreuse est extrêmement raffinée et conçue pour offrir un confort extraordinaire, dédié à un temps lent qui nous réconcilie avec nous-même et avec les autres, dans la dimension d'un espace relationnel plus intime et privé.



Carlo De Carli

Born in Milan, Carlo De Carli (1910-1999) graduated in 1934 in architecture from the Polytechnic University of Milan, worked for a year in the studio of Gio Ponti and took over the chair in interior architecture, furniture and decoration from him in 1962. Curator of the X and XI Milan Triennale, he was head of the architecture faculty from 1965 to 1968. Editor of the magazine Interni from 1967 to 1971. Design, research, teaching and promotion were the areas of action of his work, carried out with a broad communality of thinking and focused on people and the social and production context in which they operate. For De Carli the attitude behind the design of a house or of a chair does not change: "I love any form of architecture, provided it's researched, tested and essential (...) furniture too... I've designed a lot... it only seeks measure and not any effect... above all the measure that relates to the space of the home, in the sense of a tree" (Creatività, 1973). Through the publication *il mobile italiano* (1957-60) he promoted renewal of traditional furniture production centres and the coming together of international design culture, young architects and local artisans.

Technical informations



Sofa ↗ p.205

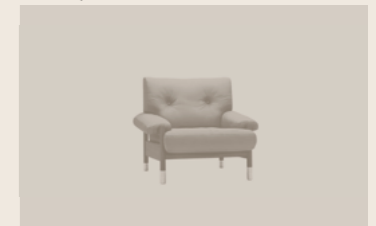

Armchair ↗ p.205

Domestic, Contract

Sofa, Armchair

Sesann

Guardando l'opera di Gianfranco Frattini, il grande maestro del moderno design italiano, questo spirito metafisico traspare da ogni curva, da ogni sottile dettaglio e dalle combinazioni dei materiali che caratterizzano i suoi progetti.

Informazioni → p.035

Riedizione di uno storico progetto di Gianfranco Frattini, Sesann è una collezione di divani e poltrone che per le sue forme morbide e accoglienti suscita una sensazione di sensualità e calore. Merito della struttura in tubolare metallico che come un'architettura avvolge, contiene ed esalta l'imbottitura. Protagonista dello spazio per i volumi importanti e il design elegante ed elaborato, Sesann si può rivestire in pelle o tessuto per creare abbinamenti cromatici e materici di grande impatto tra imbottitura, struttura e piedini in legno di frassino.

Designer, Year:
Gianfranco Frattini, (1970) 2015



Sesann (Sofa), structure T07 Black,
feet T43 Dark Walnut
W 240 D 94 H 67 H seat 38 cm



Sesann (Sofa), structure
T28 Polished Black
Chrome, feet T43 Dark Walnut
W 240 D 94 H 67 H seat 38 cm

Cage (Low Table), top T32 Black Marquina
Marble, base T27 Matt Black Chrome
/top T41 Smoked Mirror, base T28 Polished
Black Chrome ↪ Vol. B p.302

Sesann

Agnese (Armchair),
base T43 Dark Walnut
↪ Vol. B p.038

↪ Tacchini Edizioni:
E63 (Lamp) designed by Umberto Riva,
Tarsia (Tray) and Umbra (Rug)
designed by Maria Gabriella Zecca

Sesann (Sofa), structure T28 Polished
Black Chrome, feet T43 Dark Walnut
W 240 D 94 H 67 H seat 38 cm



Soap (Low Table), top T74
Sahara Noir Marble,
base T03 Grey ↪ p.290

↪ Tacchini Edizioni:
Umbra (Rug) designed by
Maria Gabriella Zecca



Sesann (Sofa), structure T28
Polished Black Chrome, feet T49 Grey
W 240 D 94 H 67 H seat 38 cm

Shelter (Armchair),
base T27 Matt Black Chrome
⇒ Vol. B p.066

Sesann

Cage (Low Table), top T32 Black Marquina
Marble, base T27 Matt Black Chrome
/top T41 Smoked Mirror, base T28 Polished
Black Chrome ⇒ Vol. B p.302



Sesann (Sofa), structure
T11 Orange, feet T43 Dark Walnut
W 240 D 94 H 67 H seat 38 cm

Sesann

Design Classic → Vol. B p.002
Discover Tacchini
process of re-editions

Respecting the thought of Gianfranco Frattini, the new edition of Sesann keeps the spirit of the product intact. Characterized by a leather upholstery, Sesann owes its typical soft and enveloping form to the structure in pine plywood, covered with polyurethane foam and encircled with an architectural tubular steel (chromed or painted), with feet in ash wood. The particular configuration of Sesann – both formal and functional – constitutes the basis for a system of products characterized by the same structural elements, but declined in unique and fascinating objects. This approach of synthesis and reduction, proposed by Frattini, produced a formally elegant design, conceptually elaborated and, above all, unique.

En Looking at the work of Gianfranco Frattini, the great master of modern Italian design, we find that this metaphysical spirit shines through every rounded shape, every detail and combinations of materials that characterize his projects. A reissue of a historic design by Gianfranco Frattini, Sesann is a collection of sofas and armchairs with soft, cosy forms that evoke feelings of warmth and sensuality, thanks to the tubular metal frame, which acts as an architectural structure, enveloping, containing and accentuating the cushioning. Sesann commands its space with its bold volumes and elegant, sophisticated design. With a choice of leather or fabric coverings to create striking combinations of colours and textures between the cushions, frame and ash wood feet.

De Betrachtet man das Werk von Gianfranco Frattini, dem großen Meister des modernen italienischen Designs, dann ist dieser metaphysische Geist in jeder Rundung zu erkennen, in jedem noch so kleinen Detail und in den Materialkombinationen, die seine Projekte auszeichnen. Sesann, Neuauflage eines historischen Modells von Gianfranco Frattini, ist eine Kollektion aus Sofas und Fauteuils. Die weichen, anheimelnden Formen lassen ein sinnliches Gefühl der Wärme entstehen. Erreicht wird das durch eine Metallrohrstruktur, die wie eine Architektur die Polsterung umschließt, zusammenhält und optimal zur Geltung bringt. Mit den wuchtigen Volumen und dem elegant raffinierten Design beherrscht Sesann den Raum; Leder- oder Stoffbezug lassen sehr effektvolle, farbliche und stoffliche Kombinationen von Polsterung, Struktur und Füßen aus Eschenholz entstehen.

Fr En regardant le travail de Gianfranco Frattini, on voit l'esprit métaphysique du grand maître du design italien moderne briller à travers chaque courbe, chaque détail subtil et dans les combinaisons de matériaux qui caractérisent ses projets. Réédition d'un projet historique de Gianfranco Frattini, Sesann est une collection de canapés et de fauteuils dont les formes douces et accueillantes suscitent une sensation de sensualité et de chaleur. Tout le mérite en revient à la structure en tube métallique qui comme une architecture enveloppe, contient et met en valeur le rembourrage. Protagoniste de l'espace grâce à ses volumes importants et à son design élégant et raffiné, Sesann peut être revêtu de cuir ou de tissu pour créer des associations de couleurs et de matières d'un grand effet entre rembourrage, structure et pieds en bois de frêne.

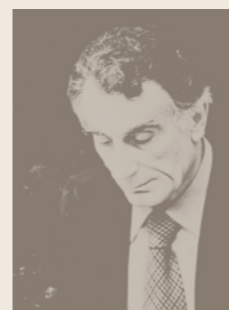

Gianfranco Frattini

Gianfranco Frattini was born in Padua, Italy, on 15th May, 1926. He graduated in Architecture, at the Politecnico, Milan, in 1953. At the end of the 50's, he is one of the founders of ADI, Association for Industrial Design. Frattini opened his own studio in Milan, after working in the office of his teacher and mentor Gio Ponti. In few years, he became an industrial designer, well-known worldwide. Among his many successful projects, in 1956 designed the chair model 849, nominated for the "Compasso d'Oro" Prize. Now, this armchair, which takes shapes from the original design, is proposed by Tacchini with the name of "Agnese".

Other products by Gianfranco Frattini:
Agnese → Vol. B p.038, Gio → Vol. B p.286,
Giulia → Vol. B p.044, Lina → Vol. B p.032,
Oliver → p.050, Sesann (Armchair) → Vol. B p.050

Technical informations



Sofa → p.206



Armchair → p.206

Roma

Quasi sospeso dal pavimento,
con esilissime gambe che sorreggono
la seduta ampia e avvolgente.

Informazioni → p.043



Roma (Sofa), base T25 Matt
Champagne Gold
W 234,5 D 121,4/84 H 73,5 cm
H seat 38,5 cm

Soap (Low Table), top T31 White
Calacatta Marble, base
T25 Matt Champagne Gold,
→ Vol. B p.290

Designer, Year:
Jonas Wagell, 2017

Jonas Wagell immagina una famiglia di divani, ispirati dal segno morbido di una curva a emiciclo: questa piccola collezione si chiama Roma, evocando in modo sensibile, dalla poltrona alla chaise longue, passando per il divano, l'ambito classico a cui si possono ricondurre i segni stilistici del disegno. Un rimando al design degli anni '50, non di manierismo ma di attenta ispirazione: per un progetto nato già 'classico', appunto, anche nel nome.

Awards: 2017 Archiproducts Design Awards



Roma (Sofa), base T25
Matt Champagne Gold
W 234,5 D 121,4/84 H 73,5 cm
H seat 38,5 cm

Roma (Armchair), base T25
Matt Champagne Gold
W 106,3 D 88,5 H 73,5 cm
H seat 38,5 cm

Soap (Low Table), top T31
White Calacatta Marble,
base T25 Matt Champagne
Gold ↪ Vol. B p.290



Roma (Sofa), base T25 Matt
Champagne Gold
W 233 D 92 H 73,5 cm
H seat 38,5 cm

Roma (Armchair), base T25
Matt Champagne Gold
W 106,3 D 88,5 H 73,5 cm
H seat 38,5 cm

Soap (Low Table), top T31
White Calacatta Marble,
base T25 Matt Champagne
Gold ↪ Vol. B p.290



Roma (Sofa), base T25
 Matt Champagne Gold
 W 234,5 D 121,4/84 H 73,5 cm
 H seat 38,5 cm

Roma

En Almost suspended above the floor, with the slenderest of legs upholding a large, cosy seat. Jonas Wagell imagines a family of sofas, inspired by the soft, curving form of a semicircle: this little collection, from armchair to sofa to chaise longue, is called Roma, a strong reference to the classical sphere in which its lines are rooted. With citations from fifties design, not of affectation, but of clear inspiration, this design is “classical” by nature, and not only in name.

De Der komfortable, körpergerechte Sitz ruht auf dünnen Beinen und scheint über dem Boden zu schweben. Jonas Wagell hat eine Linie von Sofas in den weichen Linien eines Halbrunds entworfen: die kleine Kollektion heißt Roma und alle, von Sessel und Chaiselongue bis Sofa, sind ein sehr einfühlsamer Bezug auf den klassischen Charakter dieser Stadt, der den Linien ihres Designs zugrunde liegt. Aufgegriffen wird das Design der Fünfzigerjahre, keine Nachahmung, sondern sensible Inspiration für einen geborenen „Klassiker“, wie bereits der Name sagt.

Fr Comme suspendue par rapport au sol avec des pieds très fins qui soutiennent l'assise ample et enveloppante. Jonas Wagell imagine une famille de canapés, s'inspirant de la douce sinuosité d'un hémicycle : cette petite collection s'appelle Roma, évoquant de manière sensible, du fauteuil à la chaise longue en passant par le canapé, le cadre classique auquel appartiennent les traits stylistiques du dessin. Un renvoi au design des années 1950, qui ne relève pas du maniérisme mais qui est le fruit d'une inspiration authentique pour un projet né déjà « classique », jusque dans le nom.



Jonas Wagell

Jonas Wagell is an architect and designer from Stockholm. Born in 1973, he trained as graphic artist and then specialised as an interior designer in Stockholm and New York, where he attended the Parsons School of Design. In 2008 he founded the JWDA firm which handles architecture, product design and brand management projects. Wagell is fond of creating functional items with features of simplicity and intelligence, objects which can be used and understood easily by those who choose them.

Other products by Jonas Wagell:
 Julep → p.010

Technical informations



Sofa → p.205



Armchair → p.205

Face to Face

“Siediti accanto a me. Voglio guardare il tuo viso mentre parliamo. Capire cosa pensi”. Gordon Guillaumier reinterpreta il divano e lo trasforma in uno spazio di relazione uno-a-uno.

Informazioni → p.049



Face To Face (Sofa),
base T03 Grey, yarn T79
W 196 D 97 H 73,5 cm
H seat 38 cm

Soap (Low Table),
top T74 Sahara Noir
Marble, base T03
Grey → Vol. B p.290

→ Tacchini Edizioni:
Linea (Rug) designed
by Maria Gabriella Zecca

Face to Face è un'originale reinterpretazione del divano come spazio di relazione uno-a-uno, con due schienali contrapposti e morbidi cuscini in piuma che invitano alla seduta vis à vis. Per il suo aspetto classico e leggero, Face to Face è pensato per essere protagonista a centro stanza, sia in uno spazio contract che nell'intimità di un salotto. Rivestito in tessuto o pelle, è cucito con punti incrocio a contrasto.

Designer, Year:
Gordon Guillaumier, 2017

Face to Face



Face To Face (Sofa), base T27 Matt
Black Chrome, yarn T82
W 196 D 97 H 73,5 H seat 38 cm

Soap (Low Table),
top T74 Sahara Noir
Marble, base T03
Grey ↗ Vol. B p.290

↗ Tacchini Edizioni:
Umbrà (Rug) designed
by Maria Gabriella Zecca

Face to Face



Face To Face (Sofa), base T27 Matt
Black Chrome, yarn T82
W 196 D 97 H 73,5 H seat 38 cm

Soap (Low Table),
top T74 Sahara Noir
Marble, base T03
Grey ⇒ Vol. B p.290

⇒ Tacchini Edizioni:
Umbrà (Rug) designed
by Maria Gabriella Zecca

Face to Face

En “Sit down next to me. I want to look at your face while we speak, to understand what you’re thinking.” Gordon Guillaumier reinterprets the sofa, transforming it into a space for one-on-one relations. Face to Face is an original reinterpretation of the sofa as a space for one-to-one relations, with two opposing backs and soft, feather cushions inviting people to sit vis-à-vis. With its light, classical style, Face to Face is conceived to take a central role and position, be it in contract spaces or in the intimacy of a living room. Covered in fabric or leather, it is sewn with contrasting cross-stitching.

De „Setz dich zu mir. Ich will dir ins Gesicht sehen, während wir uns unterhalten. Verstehen, was du denkst“. Gordon Guillaumier interpretiert das Sofa neu und verwandelt es in einen Raum der Beziehungen von Angesicht zu Angesicht. Face to Face ist eine originelle Neuinterpretation, die ein Sofa zum geselligen Ort für zwei Personen macht, mit zwei gegenüberliegenden Rückenlehnen und weichen Daunenkissen, die zur Unterhaltung vis à vis einladen. Klassisch und schwerelos im Aussehen, ist Face to Face ein zentraler Blickpunkt im Raum, im Objektbereich ebenso wie im privaten Salon. Bezogen mit Stoff oder Leder, mit farblich abgesetzten Kreuzstichnähten.

Fr « Assieds-toi à côté de moi. Je veux regarder ton visage quand nous parlons. Et comprendre ce que tu penses ». Gordon Guillaumier réinterprète le canapé et le transforme en un espace de relation individuelle. Face to Face est une réinterprétation originale du canapé comme espace de relation individuelle, avec deux dossiers opposés et des coussins moelleux garnis de plume qui invitent à la conversation en vis-à-vis. Avec son aspect classique et léger, Face to Face est pensé pour être protagoniste en milieu de pièce, dans un espace collectif comme dans l'intimité d'un salon. Revêtu de tissu ou de cuir, il est cousu avec des points de croix de couleur contrastante.



Gordon Guillaumier

Gordon Guillaumier was born in 1966, and was educated firstly in Malta, then in Switzerland, England and Italy. He graduated from IED in Milan (1988-91), before specializing in design at the Domus Academy, Milan (1992). In 1993 he began working with Baleri Associati, as well as collaborating with architect Rodolfo Dordoni. In 2002 he set up his own design studio in Milan, principally working on product design, but also for design consultancy projects. In 2006 he lectured in industrial design at Milan's Politecnico university.

Other products by Gordon Guillaumier:
Cage ⇒ Vol. B p.302, Chill-Out ⇒ p.132, Chill-Out
High ⇒ p.140, Coot ⇒ Vol. B p.308, Ledge ⇒ Vol. B p.316,
Soap ⇒ Vol. B p.290, Spindle ⇒ Vol. B p.274

Technical informations



Sofa ⇒ p.201

Oliver

Riedizione dello storico modello 872 disegnato da Gianfranco Frattini nel 1957, il successo senza tempo del divano Oliver testimonia l'inscindibile accostamento progettuale di linea e materia nel lavoro del celebre designer italiano.

Informazioni → p.055

Designer, Year:
Gianfranco Frattini, (1957) 2017

La leggerezza della solida struttura in acciaio verniciato o cromato sostiene seduta e schienale imbottiti, realizzati nella raffinata lavorazione artigianale a capitonné e disponibili in pelle o tessuto. I piedini a contrasto in essenza di frassino tinto sottolineano la cura del dettaglio costruttivo ed estetico, caratteristica di Frattini. Modello iconico del design contemporaneo made in Italy, Oliver coniuga il rigore dell'eleganza essenziale al comfort discreto di una costruzione impeccabile.







Oliver (Sofa), structure T02 White
W 190 D 83,5 H 77 H seat 40 cm

Oliver

Design Classic → Vol. B p.002
Discover Tacchini
process of re-editions

En A re-edition of the legendary Model 872, designed by Gianfranco Frattini in 1957, the Oliver sofa embodies the inseparable fusion of form and material in the renowned Italian designer's aesthetic concept. The visual lightness of the solid structure in powder coated or chrome steel artfully balances the sophisticated artisan craftsmanship in the hand-tufted seat and backrest, upholstered in leather or fabric. The wood feet, crafted in stained ash, emphasize the constructive and aesthetic attention to detail characteristic of Frattini's work. An iconic example of contemporary Italian design, Oliver blends the simplicity of uncluttered elegance and unpretentious comfort, flawlessly constructed.

De Das Sofa Oliver ist eine Neuauflage des ikonischen Modells 872, das Gianfranco Frattini 1957 entworfen hat, und sein zeitloser Erfolg bezeugt die untrennbare Verbindung von Linien und Materie, durch die sich die Arbeit des berühmten italienischen Designers auszeichnet. Das solide Gestell aus lackiertem oder verchromtem Stahl besticht mit seiner Leichtigkeit und stützt die gepolsterte Sitzfläche und Rückenlehne, ausgeführt in hochwertiger handwerklicher Fertigung mit Knopfleftung und erhältlich in Leder oder Stoff. Die Füße aus gebeiztem Eschenholz bilden einen eleganten Kontrast und betonen die sorgfältige Ausführung und das raffinierte Design, die für Frattini typisch sind. Oliver ist ein ikonisches Modell des zeitgenössischen Designs Made in Italy und verbindet die Strenge der minimalistischen Eleganz mit dem angenehmen Komfort einer Ausführung auf höchstem Niveau.

Fr Le succès intemporel du canapé Oliver – une réédition du modèle historique 872 conçu par Gianfranco Frattini en 1957 – témoigne de la combinaison conceptuelle indissociable de la ligne et de la matière dans l'œuvre du célèbre designer italien. La légèreté de la solide structure en acier peint ou chromé soutient l'assise et le dossier capitonnés, de facture artisanale raffinée et disponibles en cuir ou en tissu. Les pieds contrastants en bois de frêne teinté soulignent l'attention portée aux détails de construction et esthétiques qui caractérise Frattini. Oliver est un modèle iconique du design contemporain made in Italy qui allie la rigueur de l'élégance minimaliste au confort discret d'une construction impeccable.



Gianfranco Frattini

Gianfranco Frattini was born in Padua, Italy, on 15th May, 1926. He graduated in Architecture, at the Politecnico, Milan, in 1953. At the end of the 50's, he is one of the founders of ADI, Association for Industrial Design. Frattini opened his own studio in Milan, after working in the office of his teacher and mentor Gio Ponti. In few years, he became an industrial designer, well-known worldwide. Among his many successful projects, in 1956 designed the chair model 849, nominated for the "Compasso d'Oro" Prize. Now, this armchair, which takes shapes from the original design, is proposed by Tacchini with the name of "Agnese".

Other products by Gianfranco Frattini:
Agnese → Vol. B p.038, Gio → Vol. B p.286,
Giulia → Vol. B p.044, Lina → Vol. B p.032,
Sesann → p.026, Sesann (Armchair) → Vol. B p.050

Technical informations



Sofa → p.203

Domestic, Contract

Sofa, Armchair, Ottoman, Chair

Montevideo

Linee e proporzioni studiate con cura, per offrire un comfort totale: questo è il principio ispiratore del divano Montevideo.

Informazioni → p.061



Braccioli e schienale disegnano un'unica forma morbida e accogliente, completata da cuscini in piuma che sostengono la zona lombare. Ergonomico ed elegante, il divano Montevideo è inoltre abbinabile ad una poltrona coordinata. Un volume soffice che accoglie piacevolmente il corpo, un cuscino con imbottitura in piuma da posizionare liberamente per un comfort ancora più personalizzato: è la poltrona Montevideo, una sintesi di estetica ed ergonomia per gli ambienti più diversi, da sola o in abbinamento al divano dal design coordinato.

Designer, Year:
Claesson Koivisto Rune, 2008



Montevideo

Montevideo (Armchair),
base T07 Black
W 96 D 90 H 78 H seat 40 cm



Montevideo (Sofa),
base T94 Bronze
W 222 D 90 H 78 cm
H seat 40 cm

Montevideo (Armchair),
base T94 Bronze
W 96 D 90 H 78 cm
H seat 40 cm

Montevideo
(Ottoman), base
T94 Bronze
W 93 D 71 H 40 cm

Soap (Low Table), top T118 Shiny
Patagonia Marble, base T25
Matt Champagne Gold → Vol. B p.290



Montevideo

En Carefully designed shapes and sizes for all-round comfort: this is the guiding principle behind the Montevideo sofa. Armrests and backrest trace a soft and cozy outline, complete with feather cushions supporting your lower back. Ergonomic and elegant, the Montevideo sofa is also paired with a matching armchair. A soft, enveloping frame that warm accomodates the body, a feather cushion to be arranged at will for a more customized comfort: this is the Montevideo armchair, the net result of aesthetic and ergonomic principles and designed for a variety of settings, either as stand-alone or combined with its matching sofa.

De Bestens durchdachte Linien und Proportionen um umfassenden Komfort bieten zu können: das ist das inspirierende Prinzip des Sofas Montevideo. Die Arm- und Rückenlehnen ergeben eine einzige gemütliche und behagliche Form, welche durch Federkissen ergänzt wird um den Rücken zu stützen. Ergonomisch und elegant ist das Sofa Montevideo desweiteren auch mit dem koordinierbaren Sessel kombinierbar. Ein gemütliches Volumen, welches auf angenehme Art und Weise den Körper umgibt, ein mit Federn gefülltes Kissen, welches so positioniert werden kann, dass es einen noch persönlicheren Komfort schafft: das ist der Sessel Montevideo, eine Synthese aus Ästhetik und Ergonomie, geschaffen für die verschiedensten Räumlichkeiten, allein oder auch in Kombination mit dem Sofa in koordiniertem Design.

Fr Des lignes et des proportions étudiées avec soin pour offrir un confort total : voici le principe qui a inspiré la création du canapé Montevideo. Les accoudoirs et le dossier dessinent une forme unique, souple et accueillante, complétée par des coussins en plume qui soutiennent la base du dos. Ergonomique et élégant, le canapé Montevideo peut être associé en outre à un fauteuil coordonné. Un volume moelleux qui accueille agréablement le corps, un coussin avec un rembourrage en plume, peut être positionné librement pour un confort encore plus personnalisé : voici le fauteuil Montevideo, une synthèse d'esthétique et d'ergonomie pour les milieux les plus divers, seul ou associé au canapé du design coordonné.



Claesson Koivisto Rune

The Claesson Koivisto Rune studio was established in 1995 as a multidisciplinary architecture and design workshop, in line with the classic Scandinavian tradition, but with the aim of exploring new concepts, and pursuing the values of simplicity and innovation. The three Swedes have created architectural designs throughout the world and in every sector, from homes to restaurants, retail to executive buildings, as well as furniture ranges for numerous major international firms.

Other products by Claesson Koivisto Rune: Campo (Tacchini Edizioni), Doodle (Armchair, Chaise-longue) → Vol. B p.082, Doodle (Chair, Stool) → Vol. B p.228, Isola → Vol. B p.114, Kelly B → Vol. B p.296, Kelly C → Vol. B p.202, Kelly C Basic → Vol. B p.202, Kelly E → Vol. B p.072, Kelly H → Vol. B p.072, Kelly L+F → Vol. B p.072, Kelly O → Vol. B p.296, Kelly S → Vol. B p.072, Kelly T → Vol. B p.266, Kelly V → Vol. B p.210, Kelly W → Vol. B p.296, Lima → p.078, Misura S/M → Vol. B p.150, Montevideo (Chair) → Vol. B p.222, Pisa → Vol. B p.100, Quartier → Vol. B p.176, Santiago → Vol. A p.070, Spin → Vol. B p.182, Split → Vol. B p.260

Technical informations



Sofa → p.203



Armchair → p.203



Ottoman → p.203

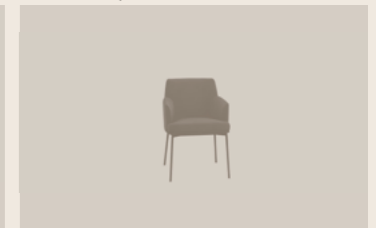

Chair → p.203

Montevideo (Sofa),
base T07 Black
W 222 D 90 H 78 H seat 40 cm

Montevideo (Armchair),
base T07 Black
W 96 D 90 H 78 H seat 40 cm

Quilt

La semplicità complessa della sintesi di modernità e classicità. PearsonLloyd disegna Quilt dando forma alla creatività di un modello che va oltre stili e definizioni, perché in se stesso sembra raccoglierne armoniosamente molti.

Informazioni → p.069

Le linee semplici ma piene del sistema di divani e poltrone Quilt, con la morbida rotondità dei cuscini della profonda seduta e la particolare lavorazione verticale dell'imbottitura di schienale e braccioli, accolgono con un'eleganza dal sapore ricercato, che arreda perfettamente spazi domestici e ambienti contract internazionali. Il lineare basamento in acciaio dona un effetto sospeso all'arredo dal design pieno e compatto, con un risultato di inaspettata leggerezza. Il sistema è completato dall'omonimo pouf di forma quadrata.

Designer, Year:
PearsonLloyd, 2007









Quilt (Sofa), base T03 Grey
W 260 D 80 H 68 H seat 41 cm

Quilt

En Modern meets classic in an alliance based on simplicity. Designed by PearsonLloyd, Quilt is the creative expression of a style that defies fashions and definitions because it appears to elegantly embrace many of them. The clean yet voluptuous lines of the Quilt sofa and armchair system, the rounded softness of the deep seat cushions and the special vertical stitching on the quilted backrest and armrests all lend an air of sophisticated elegance, perfect for home decor and international contract settings. Thanks to the sleek steel base, the pieces appear to float just above the floor. The rich yet compact design yields unexpected visual lightness. The square Quilt ottoman completes the system.

De Die komplexe Schlichtheit der Verschmelzung von Moderne und Klassik. Das Designstudio PearsonLloyd hat das Sofa Quilt entworfen und dabei der Kreativität eines Modells eine Form verliehen, die über Stil und Definitionen hinausgeht und viele verschiedene Elemente harmonisch in sich vereint. Die schlichten und gleichzeitig großzügigen Linien der Sofas und Sessel der Kollektion Quilt mit den charakteristischen abgerundeten Kissen der sehr tiefen Sitzfläche und der besonderen vertikalen Steppung bestechen mit ihrer Eleganz und ihrem geschmackvollen Design und machen Quilt perfekt für Wohnungen und für die internationale Objekteinrichtung. Mit ihrem linearen Gestell aus Stahl scheinen die kompakten und üppigen Polstermöbel über dem Boden zu schweben, wodurch der Eindruck einer unerwarteten Leichtigkeit entsteht. Ergänzt wird die Kollektion durch den gleichnamigen quadratischen Polsterhocker.

Fr La simplicité complexe de la synthèse de la modernité et du classicisme. En dessinant Quilt, PearsonLloyd a donné forme à la créativité d'un modèle qui va au-delà des styles et des définitions car il semble en englober harmonieusement un bon nombre. Les lignes simples mais pleines du système de canapés et de fauteuils Quilt, caractérisé par la douce rondeur des profonds coussins d'assise et par la facture originale du rembourrage vertical du dossier et des accoudoirs, sont accueillantes et leur élégance sophistiquée meuble à merveille les espaces domestiques et ceux du secteur contract international. Le piètement linéaire en acier donne un effet suspendu à ce meuble au design plein et compact qui résulte ainsi d'une légèreté inattendue. Le pouf carré du même nom vient compléter le système.



PearsonLloyd

PearsonLloyd is one of the leading names in contemporary British design, and this multidisciplinary studio works in a wide range of sectors: from furnishing to public spaces to brand development. Established by Luke Pearson and Tom Lloyd in 1997, the studio has received numerous acknowledgements and accolades in both Europe and the United States. The British design duo write regularly for major design magazines, as well as acting as "visiting lecturers" at the École Cantonale d'Art in Lausanne.

Other products by PearsonLloyd:
Crystal ↪ p.098, Crystal (Armchair) ↪ Vol. B p.108,
Eddy ↪ Vol. B p.240, Fixie ↪ Vol. B p.252,
Galleria ↪ p.148, Ischia ↪ p.124, Nebula (Tacchini Edizioni), Polar ↪ p.162, Polar Perch ↪ p.170,
Polar Table ↪ Vol. B p.312, Stone High/Low ↪ p.180

Technical informations



Sofa ↪ p.204



Armchair, Ottoman ↪ p.204

Santiago

Morbide e accoglienti, le sedute della collezione Santiago nascono da un abile gioco di proporzioni.

Informazioni → p.077



Morbide e accoglienti, le sedute della collezione Santiago nascono da un abile gioco di proporzioni. Piedini esili e di altezza ridotta sostengono i volumi rotondi e generosi della seduta e dello schienale, creando forme piene che anche visivamente invitano al comfort e al riposo. La collezione è composta da un divano e da una poltrona con poggiatesta, che vivono da soli o insieme, dentro ambienti dagli stili più diversi.

Awards: 2017 German Design Awards

Designer, Year:
Claesson Koivisto Rune, 2016



Santiago (Armchair),
base T03 Grey
W 96 D 88 H 85 cm
H seat 41 cm

Santiago (Ottoman),
base T03 Grey
W 93 D 71 H 40 cm



Santiago (Sofa),
base T03 Grey
W 164 D 88 H 85 cm
H seat 41 cm

Santiago (Armchair),
base T03 Grey
W 96 D 88 H 85 cm
H seat 41 cm

Soap (Low Table),
top T74 Sahara Noir
Marble, base T03
Grey ↗ Vol. B p.290

Santiago

↗ Tacchini Edizioni:
E63 (Lamp) designed by
Umberto Biva



Santiago (Sofa),
base T02 White
W 164 D 88 H 85 cm
H seat 41 cm

Santiago (Armchair),
base T02 White
W 96 D 88 H 85 cm
H seat 41 cm

Santiago (Ottoman),
base T02 White
W 93 D 71 H 40 cm

Santiago

↪ Tacchini Edizioni:
Campo (Rug) designed by
Claesson Koivisto Rune



Santiago (Sofa),
base T02 White
W 164 D 88 H 85 cm
H seat 41 cm

↳ Tacchini Edizioni:
Campo (Rug) designed by
Claesson Koivisto Rune

Santiago

En The soft and cosy seating of the Santiago collection is the fruit of the skilled use of proportions. Slim, short legs, support the generous, round volumes of the seat and back, to create full shapes that offer a visual invitation to find comfort and rest. The collection includes a sofa and an armchair with footrest, which can live alone or together, in settings with a diverse range of styles.

De Die weichen, komfortablen Sitzmöbel der Kollektion Santiago entstehen aus einem Spiel mit Proportionen. Schlanke, nicht sehr hohe Füße stützen die runden, großzügigen Volumen von Sitzfläche und Rückenlehne, volle Formen, die auch optisch Komfort und Entspannung signalisieren. Die Kollektion besteht aus einem Sofa und einem Lehnstuhl mit Fußstütze, die einzeln oder gemeinsam in stilistisch unterschiedlichen Räumen gut bestehen können.

Fr Avec leurs lignes douces et accueillantes, les fauteuils et les canapés Santiago jouent habilement avec les proportions. Les pieds fins et de hauteur réduite soutiennent les volumes ronds et généreux de l'assise et du dossier en créant des formes pleines qui, y compris sur le plan visuel, invitent au confort et au repos. La collection est composée d'un canapé et d'un fauteuil avec repose-pieds, utilisables seuls ou ensemble, dans les contextes les plus variés.



Claesson Koivisto Rune

The Claesson Koivisto Rune studio was established in 1995 as a multidisciplinary architecture and design workshop, in line with the classic Scandinavian tradition, but with the aim of exploring new concepts, and pursuing the values of simplicity and innovation. The three Swedes have created architectural designs throughout the world and in every sector, from homes to restaurants, retail to executive buildings, as well as furniture ranges for numerous major international firms.

Other products by Claesson Koivisto Rune:
Campo (Tacchini Edizioni), Doodle (Armchair, Chaise-longue) ↳ Vol. B p.082, Doodle (Chair, Stool) ↳ Vol. B p.228, Isola ↳ Vol. B p.114, Kelly B ↳ Vol. B p.296, Kelly C ↳ Vol. B p.202, Kelly C Basic ↳ Vol. B p.202, Kelly E ↳ Vol. B p.072, Kelly H ↳ Vol. B p.072, Kelly L+F ↳ Vol. B p.072, Kelly O ↳ Vol. B p.296, Kelly S ↳ Vol. B p.072, Kelly T ↳ Vol. B p.266, Kelly V ↳ Vol. B p.210, Kelly W ↳ Vol. B p.296, Lima ↳ p.078, Misura S/M ↳ Vol. B p.150, Montevideo (Sofa, Armchair, Ottoman) ↳ p.056, Montevideo (Chair) ↳ Vol. B p.222, Pisa ↳ Vol. B p.100, Quartier ↳ Vol. B p.176, Spin ↳ Vol. B p.182, Split ↳ Vol. B p.260

Technical informations



Sofa ↳ p.205

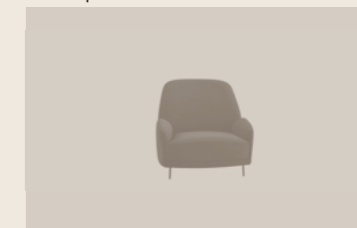

Armchair ↳ p.205



Ottoman ↳ p.205

Lima

La sensualità decorativa di forme generose elegantemente appoggiate a tratti sottili, un irresistibile contrasto che disegna spazi da vivere e guardare.

Informazioni → p.083



Lima (Armchair),
base T07 Black
W 89 D 91 H 78,5 cm
H seat 39,5 cm

Lima (Ottoman),
base T07 Black
W 89 D 70 H 39,5 cm

Designer, Year:
Claesson Koivisto Rune, 2012

Lima

Lima è un sistema di divani, poltrone e pouf dal carattere distintivo di grande ispirazione. Il progetto del trio di architetti e designer svedesi Claesson Koivisto Rune unisce l'ergonomia di una seduta, profonda, accogliente, estremamente confortevole nell'introduzione del secondo cuscino dello schienale, promessa di un piacevole momento di relax o conversazione, all'accattivante estetica di un oggetto d'arredo in grado di attribuire un gusto raffinato a qualsiasi ambiente, pubblico o privato. Base tubolare in metallo verniciato, rivestimento in molteplici finiture.



Lima (Sofa),
base T07 Black
W 213 D 91 H 78,5 cm
H seat 39,5 cm

Lima (Armchair),
base T07 Black
W 89 D 91 H 78,5 cm
H seat 39,5 cm



Lima

En The decorative sensuality of generous shapes elegantly poised above slender feet forms an enticing contrast that composes spaces to be lived in and enjoyed. Lima is a distinctive, inspired system of sofas, armchairs and ottomans. The project by the trio of Swedish designers, Claesson Koivisto Rune, weds the ergonomic pleasure of a deep, welcoming and outlandishly comfortable seat – thanks to the addition of a second cushion on the backrest that promises a pleasurable place to unwind or converse – to the irresistible aesthetic of a piece of furniture designed to lend sophistication to any room, public or private. Powder-coated tubular metal base and many different upholstery and finish options.

De Die dekorative Sinnlichkeit üppiger Formen, die elegant auf zierlichen Füßen ruhen, bildet einen unwiderstehlichen Kontrast für die Gestaltung von Räumen zum Wohnen und zum Anschauen. Lima ist eine Kollektion mit Sofas, Sesseln und Polsterhockern mit einzigartigem Charakter, der eine große Inspiration ist. Der Entwurf stammt von dem schwedischen Architekten- und Designertrio Claesson Koivisto Rune und verbindet die Ergonomie einer tiefen, behaglichen und extrem komfortablen Sitzfläche und eines zweiten, zusätzlichen Rückenkissens, das angenehme Momente der Entspannung oder des geselligen Beisammenseins verspricht, mit der hochkarätigen Ästhetik eines Einrichtungsgegenstands, der jedes öffentliche oder private Ambiente mit geschmackvoller Eleganz bereichert. Metallgestell mit Füßen aus lackiertem Rundprofil, Bezug in zahlreichen Ausführungen.

Fr La sensualité décorative de formes généreuses élégamment soutenues par des traits fins crée un contraste irrésistible qui dessine des espaces à vivre et à regarder. Lima est un système de canapés, fauteuils et poufs au caractère distinctif et très inspirant. Le projet du trio d'architectes et designers suédois Claesson Koivisto Rune conjugue l'ergonomie d'une assise, profonde, accueillante et extrêmement confortable grâce à l'introduction du deuxième coussin du dossier, promesse d'un moment agréable de détente ou de conversation, avec l'esthétique accrocheuse d'un meuble capable d'apporter une touche de raffinement à n'importe quel espace, public ou privé. Piètement tubulaire en métal peint, revêtement disponible en plusieurs finitions.



Claesson Koivisto Rune

The Claesson Koivisto Rune studio was established in 1995 as a multidisciplinary architecture and design workshop, in line with the classic Scandinavian tradition, but with the aim of exploring new concepts, and pursuing the values of simplicity and innovation. The three Swedes have created architectural designs throughout the world and in every sector, from homes to restaurants, retail to executive buildings, as well as furniture ranges for numerous major international firms.

Other products by Claesson Koivisto Rune: Campo (Tacchini Edizioni), Doodle (Armchair, Chaise-longue) → Vol. B p.082, Doodle (Chair, Stool) → Vol. B p.228, Isola → Vol. B p.114, Kelly B → Vol. B p.296, Kelly C → Vol. B p.202, Kelly C Basic → Vol. B p.202, Kelly E → Vol. B p.072, Kelly H → Vol. B p.072, Kelly L+F → Vol. B p.072, Kelly O → Vol. B p.296, Kelly S → Vol. B p.072, Kelly T → Vol. B p.266, Kelly V → Vol. B p.210, Kelly W → Vol. B p.296, Misura S/M → Vol. B p.150, Montevideo (Sofa, Armchair, Ottoman) → p.056, Montevideo (Chair) → Vol. B p.222, Pisa → Vol. B p.100, Quartier → Vol. B p.176, Santiago → Vol. A p.070, Spin → Vol. B p.182, Split → Vol. B p.260

Technical informations



Sofa → p.203



Armchair → p.203

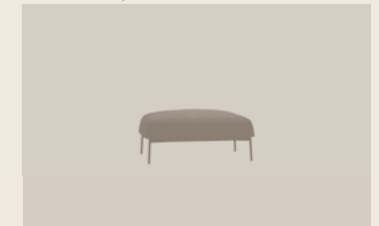

Ottoman → p.203

Lima (Armchair),
base T07 Black
W 89 D 91 H 78,5 cm
H seat 39,5 cm

Lima (Ottoman),
base T07 Black
W 89 D 70 H 39,5 cm

Quadro

Quadro è un sistema modulare che consente di creare divani, poltrone e pouf di qualsiasi tipologia e dimensione.

Informazioni → p.091



Designer, Year:
Pietro Arosio, 2001

Quadro è un sistema modulare che consente di creare divani, poltrone e pouf di qualsiasi tipologia e dimensione, risolvendo ogni necessità d'utilizzo e di ambientazione, con semplicità e senso del comfort: nei piccoli come nei grandi spazi. Tutti i rivestimenti sono sfoderabili.



Quadro (Sofa)
W 98 D 98 H 66 + W 70 D 98 H 66
+ W 70 D 70 H 36 H seat 36 cm

Lina (Armchair),
base T43 Dark Walnut
⇒ Vol. B p.032

Quadro

⇒ Tacchini Edizioni: Narciso (Rug) designed
by Umberto Riva, Daze (Low Table)
designed by Truly Truly, Mantiqueira (Vase)
designed by Domingos Tótor





Quadro

En Quadro is a modular system which enables several configurations of sofas, armchairs and ottomans in a variety of combinations and dimensions addressing the needs of any space or environment with simplicity and comfort for large and small spaces. All covers are removable.

De Quadro ist ein modulares System: die schlichten Formen können sich zu Sofas, Sessels, Hocker und grossen Wohnlandschaften formen, für jede Nutzung und Lebensraum. Alle Bezüge sind abnehmbar.

Fr Quadro est un système modulaire qui permet de créer des canapes, des fauteuils et des poufs de quelconque typologie et dimension, pour résoudre chaque besoin d'emploi et d'ambiance, avec simplicité et le sens du confort : dans les petits comme dans les grands espaces. Tous les revêtements sont déhoussable.



Pietro Arosio

Pietro Arosio was born in 1946 in Lissone, near Milan. He learnt his profession at the research centre of a company specialising in the production of metal furniture for communal spaces. This experience led to the emergence of a design philosophy that developed over time through his work as an industrial designer. He began his career in 1972, and was already winning accolades in 1983, receiving the Casaviva d'Oro award. The fundamentals of his work include essentiality, research into new materials and technologies, and attention to detail and to the engineering implications of his designs. Pietro Arosio is fully aware of the emotional impact his products can have, and has worked in partnership with various internationally-acclaimed artists, including Nespolo, Del Pezzo, Hsiao Chin, Tilson, Rotella and Keizo. A number of his pieces have been exhibited at the Victoria and Albert Museum in London, and at the Munich modern art museum Die Sammlung.

Other products by Pietro Arosio:
Intercity ⇨ p.190, Moon ⇨ Vol. B p.144,
Parentesi ⇨ Vol. B p.132, Slalom ⇨ Vol. B p.192,
Sliding ⇨ p.112, XL ⇨ Vol. B p.162

Technical informations

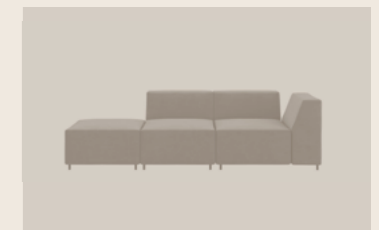

Sofa, Armchair, Ottoman ⇨ p.204

Quadro (Sofa)
W 98 D 98 H 66 + W 70 D 98 H 66
+ W 70 D 70 H 36 H seat 36 cm

Polar Table (Low Table),
finish T20 Shiny Black
⇨ Vol. B p.312

Domestic, Contract

Sofa

Dressed

Un divano a due o tre posti reso particolare da una lavorazione ispirata al mondo dello sportswear.

Informazioni → p.097

Un divano a due o tre posti reso particolare da una lavorazione ispirata al mondo dello sportswear: le imbottiture sono cucite direttamente nel rivestimento, come se fossero protezioni di un capo tecnico. Una soluzione capace di rendere fresco e contemporaneo un divano dalle linee rigorose, adatto per la casa ma anche per uffici e sale d'attesa.

Designer, Year:
Luca Nichetto, 2010



Dressed

Dressed (Sofa),
base T07 Black
W 220 D 88 H 81 cm
H seat 40 cm

Coot (Low Table),
top T32 Black Marquinia
Marble, base T07 Black
→ Vol. B p.308



Dressed (Sofa),
base T07 Black
W 220 D 88 H 81 cm
H seat 40 cm

Coot (Low Table),
top T32 Black Marquinia
Marble, base T07 Black
→ Vol. B p.308



Dressed (Sofa),
base T02 White
W 220 D 88 H 81 cm
H seat 40 cm

Quartier (Ottoman)
⇒ Vol. B p.176

Coot (Low Table),
top T29 Shiny
White Carrara Marble,
base T02 White
⇒ Vol. B p.308

Dressed

En A two or three-seat sofa with a distinctive sportswear-inspired look: the padding is sewn directly into the covers, as if it were the protection of a technical garment. A fresh, contemporary solution for a sofa with clean, rigorous lines, equally suitable for the home or for offices and waiting rooms.

De Ein zwei- oder dreisitziges Sofa in einer besonderen Ausfertigung, die sich an Sportbekleidung orientiert: die Polsterungen sind direkt auf den Bezug genäht, so wie der Schutz von Funktionsbekleidung. Das gibt dem Sofa der rigorosen Linien einen frischen, zeitgemäßen Charakter, perfekt nicht nur im häuslichen Bereich, sondern auch im Büro oder Wartezimmer.

Fr Un canapé à deux ou trois places rendu particulier par une fabrication s'inspirant aux vêtements sportifs : les rembourrages sont cousus directement dans le revêtement, comme s'il s'agissait des protections d'un vêtement technique. Une solution qui apporte une note fraîche et contemporaine à un canapé aux lignes rigoureuses, adapté aux espaces domestiques comme aux bureaux et aux salles d'attente.



Luca Nichetto

Luca Nichetto was born in Venice in 1976, and graduated in Industrial Design at IUAV university of architecture in Venice. In 1999 he launched his professional career, designing his first products in Murano glass. Later the same year he began working with Foscarini, designing a number of products for the firm and working as a consultant for research into new materials and product development (2001-2003). In 2006 he set up his own agency, Nichetto&Partners, dealing in both industrial design and design consultancy. He has received a number of international prizes, including the Gran Design Award 2008, the Chicago Atheneum Museum of Architecture Good Design Award 2008, the IF Product Design Award 2008 and the Elle Decoration International Design Awards 2009 (EDIDA) as Designer of the Year in the Young Designer Talent category. He has held workshops in numerous universities both in Italy and abroad, and has exhibited in Europe, the United States and Japan.

Technical informations



Sofa ⇒ p.201

Crystal

Crystal è un progetto dall'estetica sofisticata e inconsueta.

Informazioni → p.103



Designer, Year:
PearsonLloyd, 2011

Crystal è un progetto dall'estetica sofisticata e inconsueta. La collezione comprende il divano – che combina linee oblique e linee curve ed è proposto in due dimensioni – e la poltrona dalla particolare forma tonda. Fil rouge della serie è la base invisibile, che fa sembrare le sedute sospese. Divani e poltrone vivono da soli oppure possono essere accostati per dare vita a composizioni suggestive ed efficaci, dentro ambienti domestici così come negli spazi contract.



Crystal (Sofa)
W 213 D 85 H 68 cm
H seat 46 cm

Crystal (Armchair)
W 96 D 80 H 68 cm
H seat 43 cm

Cage (Low Table), top T42
Bronzed Mirror, base
T25 Matt Champagne Gold
⇒ Vol. B p.302

Crystal



Crystal

En Crystal is a design with a sophisticated and unusual aesthetic. The collection includes a sofa – which combines oblique and curved lines, and comes in two sizes – and an armchair with a distinctive round shape. The key feature in both cases is the invisible base, which gives the impression that they are floating above the ground. Sofas and armchairs can stand alone or be grouped together to create spellbindingly effective compositions that look great both in domestic and contract settings.

De Crystal ist ein Entwurf von raffinierter, origineller Ästhetik. Die Kollektion besteht aus Sofa – in dem sich schräge und runde Linien verbinden, angeboten in zwei Größen – und Fauteuil in einer sehr besonderen, rundlichen Form. Fil rouge ist die unsichtbare Basis, die dem Sitzmöbel eine schwebende Optik verleiht. Sofas und Fauteuils können einzeln eingesetzt werden oder zu optisch sehr effektvollen Kompositionen für den häuslichen Bereich, aber auch für Objekteinrichtungen verbunden werden.

Fr Crystal est un projet à l'esthétique sophistiquée et inhabituelle. La collection comprend le canapé – qui combine des lignes obliques et des lignes courbes et est proposé en deux dimensions – et le fauteuil avec sa forme ronde particulière. Le fil rouge de la série est la base invisible, qui donne l'impression que les éléments sont suspendus. Les canapés et les fauteuils peuvent être utilisés seuls ou regroupés pour donner vie à des compositions suggestives et efficaces, dans des environnements domestiques comme dans les espaces collectifs.



PearsonLloyd

PearsonLloyd is one of the leading names in contemporary British design, and this multidisciplinary studio works in a wide range of sectors: from furnishing to public spaces to brand development. Established by Luke Pearson and Tom Lloyd in 1997, the studio has received numerous acknowledgements and accolades in both Europe and the United States. The British design duo write regularly for major design magazines, as well as acting as "visiting lecturers" at the École Cantonale d'Art in Lausanne.

Other products by PearsonLloyd:
 Crystal (Armchair) → Vol. B p.108, Eddy → Vol. B p.240, Fixie → Vol. B p.252, Galleria → p.148, Ischia → p.124, Nebula (Tacchini Edizioni), Polar → p.162, Polar Perch → p.170, Polar Table → Vol. B p.312, Quilt → p.062, Stone High/Low → p.180

Technical informations



Sofa → p.201



Armchair → p.201

Crystal (Sofa)
 W 213 D 85 H 68 cm
 H seat 46 cm

Crystal (Armchair)
 W 96 D 80 H 68 cm
 H seat 43 cm

Sancarlo (Armchair), base
 T06 Grey → Vol. B p.120

Cage (Low Table),
 top T32 Black Marquinia
 Marble, base T07 Black
 → Vol. B p.302

Contract

Labanca

Un modello dalla progettualità multifunzionale d'avanguardia, pensato per spazi caratterizzati dal gusto internazionale del design che arreda con originale essenzialità e minimalismo.

Informazioni → p.111



Designer, Year:
Lievore Altherr Molina, 2004

Sofa, Armchair

La semplicità di una linea netta e la proporzione estetica di volumi sottili di elegante simmetria. Labanca, design by Lievore Altherr Molina, è un divano dalla struttura leggera interamente imbottita, costituita dall'elemento unico della seduta autoportante, che accoglie lo schienale delicatamente inclinato. Infinite le possibilità compositive, con una modularità estremamente accattivante nella ripetizione. Ideale negli spazi contract, pubblici e privati, nelle aree di attesa di studi e ambienti di varie dimensioni, gioca con rivestimenti e colori per un effetto visivo coinvolgente, che esalta la bellezza delle geometrie cromatiche. Il divano Labanca è completato dal tavolino Labanca Table.





Labanca (Sofa)
W 240 D 62 H 74 cm
H seat 39,5 cm

Labanca (Armchair)
W 80 D 62 H 74 cm
H seat 39,5 cm

Labanca Table (Low Table),
top T38 White Rear
Painted Glass ↗ Vol. B p.320





Labanca

En Multifunctional leading-edge design distinguishes this style, meant to enhance spaces with an international sense of decor that tends to the unique and minimalist. The clean lines and elegant proportions spell simplicity wrought of slender shapes and sophisticated symmetry. Labanca, designed by Lievore Altherr Molina, is an entirely upholstered, light-as-air sofa formed by a self-supporting seat upon which a gently slanted backrest is delicately perched. The number of possible arrangements is limitless, thanks to the extremely eye-catching repetition of its modular structure. A perfect fit for contract spaces, public and private, in waiting rooms, offices and rooms of various sizes, the interplay of upholstery options and colors yields an engaging visual effect that plays up the beauty of the colorful geometric shapes. Complementing the Labanca sofa is the Labanca side table.

De Ein Modell mit multifunktionellem, avantgardistischem Design, gedacht für Räume, die durch den internationalen Geschmack einer essentiellen und minimalistischen Einrichtung geprägt sind. Die Schlichtheit einer klaren Linie und die ästhetischen Proportionen schlanker Volumen mit eleganter Symmetrie. Labanca vom Designer Lievore Altherr Molina ist ein Sofa mit einem leichten, komplett gepolsterten Gestell und besteht aus einem einzigen, selbsttragenden Sitzelement, an dem die leicht nach hinten geneigte Rückenlehne angebracht ist. Die einzelnen Elemente der Kollektion bieten zahllose Gestaltungsmöglichkeiten mit einer Modularität, die durch ihre Wiederholbarkeit extrem ansprechend ist. Das Sofa ist ideal für öffentliche und private Objekteinrichtungen und Wartebereiche in Studios und Räumlichkeiten unterschiedlicher Größe und spielt mit unterschiedlichen Bezügen und Farben, die ein Gesamtbild schaffen, das die Schönheit der farblichen Geometrien unterstreicht. Ergänzt wird das Sofa Labanca durch den Couchtisch Labanca Table.

Fr Ce modèle foisonnant de possibilités projectuelles novatrices est conçu pour des espaces caractérisés par un style international de design qui meuble avec une originalité essentielle et minimaliste. La simplicité d'une ligne nette et la proportion esthétique de volumes minces d'une symétrie élégante. Le canapé Labanca, dessiné par Lievore Altherr Molina, arbore une structure légère entièrement rembourrée, composée d'un élément unique d'assise autoportant qui accueille un dossier délicatement incliné. Les possibilités de composition sont infinies et sa modularité extrêmement captivante dans la répétition. Idéal dans les espaces contract, publics et privés, dans les espaces d'attente des agences et les locaux de différentes tailles, il joue avec les revêtements et les couleurs pour un effet visuel accrocheur qui rehausse la beauté des géométries chromatiques. Le canapé Labanca est assorti de la table basse Labanca Table.



Lievore Altherr Molina

Born in 1948, Alberto Lievore studied architecture in Buenos Aires. In the early years he focused not only on design, but also on the production and marketing of furniture, then, having moved to Barcelona, he was part of the Grupo Berenguer (1977), a leading name in Spanish design. In 1984 he inaugurated his own studio, focusing on industrial design, and on consultancy and art direction for a number of firms. His partners are designer and stylist Jeannette Altherr, who specializes in objects and spaces for children, and Manel Molina, who again brings with him vast and varied experiences in the industrial and exhibition design sectors.

Products by Lievore Altherr Molina:
Baobab ⇨ Vol. B p.126, Girola ⇨ Vol. B p.166,
Havana ⇨ p.118, Labanca Table ⇨ Vol. B p.320,
Nara ⇨ Vol. B p.324

Technical informations



Sofa ⇨ p.202

Labanca (Armchair)
W 80 D 62 H 74 cm
H seat 39,5 cm

Labanca Table (Low Table),
top T38 White Rear
Painted Glass ⇨ Vol. B p.320

Domestic, Contract

Sliding

Un divano essenziale ed elegante,
che si trasforma in un
comodo letto a due piazze.

Informazioni → p.117

®

Brevettato
Patented

Designer, Year:
Pietro Arosio, 2000

Sofa, Sofa Bed

Un divano essenziale ed elegante, caratterizzato dalla base in pressofusione di alluminio, che si trasforma in un comodo letto a due piazze, semplicemente abbassando lo schienale con meccanismo brevettato. I cuscini con imbottitura in piuma d'oca, sono funzionali ad entrambi gli utilizzi. Tutti i rivestimenti sono sfoderabili.



Sliding

Sliding (Sofa, Sofa Bed),
base T03 Grey
W 204 D 100/144 H 83/42 cm
H seat 42 cm





Sliding (Sofa, Sofa Bed),
base T03 Grey
W 204 D 100/144 H 83/42 cm
H seat 42 cm

Sliding

En A practical and extremely elegant sofa characterized by its base in cast aluminium which transforms itself into a comfortable double bed simply by lowering the backrest via the patented mechanism. The cushions are upholstered in duck down. All covers are removable.

De Ein elegantes schlichtes Sofa, zeichnet sich durch sein Aluminiumgestell auf Rollen aus, verwandelbar in ein bequemes Doppelbett durch einfaches Runterdrücken der Lehne. Die Kissen mit Daunenfüllung sind für beide Anwendungen funktionell. Alle Bezüge sind abziehbar.

Fr Un canapé essentiel et élégant, caractérisé avec la base moulage sous pression en aluminium, qui se transforme dans un lit confortable à deux places, simplement en baissant le dossier arrière avec le mécanisme breveté. Les coussins rembourrés avec plume d'oie sont fonctionnels pour les deux emplois. Tous les revêtements sont amovibles.



Pietro Arosio

Pietro Arosio was born in 1946 in Lissone, near Milan. He learnt his profession at the research centre of a company specialising in the production of metal furniture for communal spaces. This experience led to the emergence of a design philosophy that developed over time through his work as an industrial designer. He began his career in 1972, and was already winning accolades in 1983, receiving the Casaviva d'Oro award. The fundamentals of his work include essentiality, research into new materials and technologies, and attention to detail and to the engineering implications of his designs. Pietro Arosio is fully aware of the emotional impact his products can have, and has worked in partnership with various internationally-acclaimed artists, including Nespolo, Del Pezzo, Hsiao Chin, Tilson, Rotella and Keizo. A number of his pieces have been exhibited at the Victoria and Albert Museum in London, and at the Munich modern art museum Die Sammlung.

Other products by Pietro Arosio:
Intercity ↪ p.190, Moon ↪ Vol. B p.144,
Parentesi ↪ Vol. B p.132, Quadro ↪ p.084,
Slalom ↪ Vol. B p.192, XL ↪ Vol. B p.162

Technical informations



Sofa, Sofa Bed ↪ p.206

Domestic, Contract

Sofa, Sofa Bed

Havana

Havana è una sintesi armoniosa di eleganza e flessibilità.

Informazioni → p.123

Designer, Year:
Lievore Altherr Molina, 2005

Da elegante divano protagonista dello spazio, si trasforma in comodo letto dotato di contenitore, con un semplice gesto. Versatile anche l'estetica, grazie alla scelta fra più rivestimenti sfoderabili e basi con rivestimento in alluminio o wengè.



Havana

Havana (Sofa, Sofa Bed),
base Aluminium
W 225 D 102 H 69 cm
H seat 38 cm





Havana (Sofa, Sofa Bed),
base Aluminium
W 225 D 102 H 69 cm
H seat 38 cm

Havana

En Havana is a synthesis of elegance and flexibility. From an elegant centrepiece of any space it can be transformed with a simple action into a bed with storage. Versatile also by virtue of the choice of a number removable covers and base options in aluminium or wengé finish.

De Havana ist eine Synthese aus Eleganz und Flexibilität. Aus einem Sofa der schlichten Linien wird mit einem einfachen Handgriff ein bequemes Bett mit praktischem Stauraum. Die Bezüge sind abziehbar, das Untergestell mit Verkleidung aus Aluminium oder Wengé.

Fr Havana est une synthèse harmonieuse d'élégance et de flexibilité. Il se transforme de canapé élégant protagoniste de l'espace à un lit confortable équipé de rangement, avec un simple geste. Versatile dans l'esthétique, grâce au choix parmi plusieurs revêtements amovibles et bases avec revêtement en aluminium ou wengé.



Lievore Altherr Molina

Born in 1948, Alberto Lievore studied architecture in Buenos Aires. In the early years he focused not only on design, but also on the production and marketing of furniture, then, having moved to Barcelona, he was part of the Grupo Berenguer (1977), a leading name in Spanish design. In 1984 he inaugurated his own studio, focusing on industrial design, and on consultancy and art direction for a number of firms. His partners are designer and stylist Jeannette Altherr, who specializes in objects and spaces for children, and Manel Molina, who again brings with him vast and varied experiences in the industrial and exhibition design sectors.

Products by Lievore Altherr Molina:
Baobab ↪ Vol. B p.126, Girola ↪ Vol. B p.166,
Labanca ↪ p.104, Labanca Table ↪ Vol. B p.320,
Nara ↪ Vol. B p.324

Technical informations



Sofa, Sofa Bed ↪ p.202

Ischia

In principio sono le rocce plasmate dall'aria e dall'acqua, le venature dei sassi, le sovrapposizioni e gli incastri perfetti creati dalla natura.

Informazioni → p.131



Poi, quando la forma organica ispira quella artistica, nascono i monoliti di Barbara Hepworth e le opere astratte di Serge Poliakoff. Si colloca su questa linea il nuovo progetto di PearsonLloyd, un sistema modulare influenzato da forme naturali e suggestioni artistiche, destinato ad ambienti collettivi. Ischia è composto di elementi singoli, liberamente combinabili: i sedili sono singoli o doppi, senza schienale o con schienale. Il sistema offre la possibilità di aggiungere il tavolino o il paravento in paglia di Vienna, che separa e nasconde. L'essenzialità degli elementi, caratterizzati da forme morbide e linee oblique, è bilanciata dalle finiture importanti delle basi in legno o marmo che connettono tra loro gli elementi.

Awards: 2018 Wallpaper* Design Award

Designer, Year:
PearsonLloyd, 2017



Ischia (Modular System), base T49 Grey, yarn T85, table base T03 Grey, table top T32 Black Marquinia Marble





Ischia (Modular System), base T49 Grey,
yarn T85, table base T03 Grey,
table top T32 Black Marquinia Marble

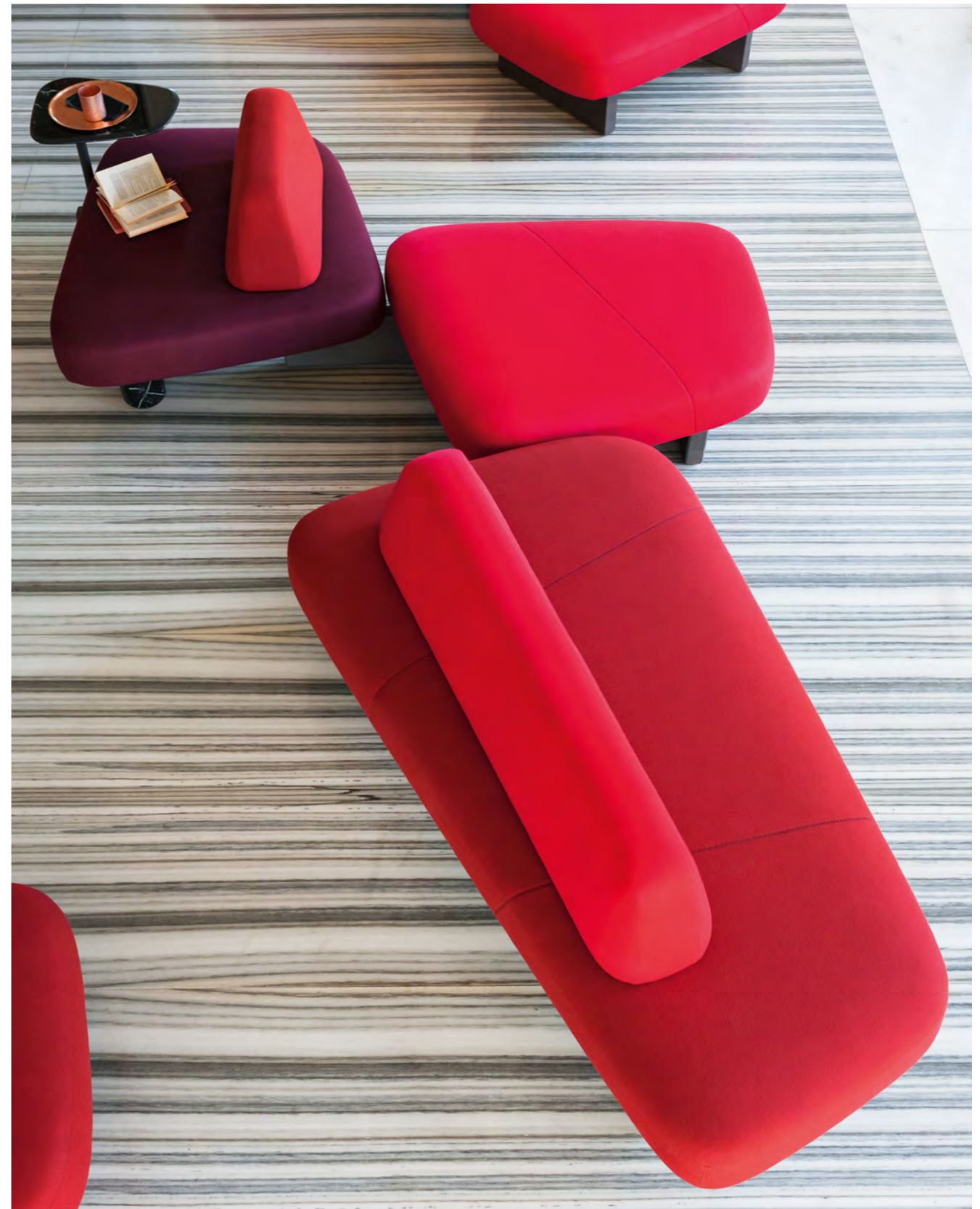

Ischia (Modular System), base T49 Grey,
yarn T85, table base T03 Grey,
table top T32 Black Marquinia Marble



Ischia (Screen), frame T49 Grey
W 135,5 D 45 H 136,9 cm

Ischia

En In the beginning there were rocks, shaped by the wind and the waters, veined stones, perfectly overlaid or slotted together by nature. Then, when organic shapes inspired artistic forms, we saw monoliths such as those of Barbara Hepworth and abstract paintings from Serge Poliakoff. Descended from this same line is the new design by Pearson Lloyd, a modular system influenced by natural shapes and artistic allusions, destined for collective settings. Ischia comprises a number of freely-combinable individual components: the seats can be single or double, and come with or without a backrest. The system also offers the possibility of adding a table or a woven cane screen, to keep any given area separate and hidden away. The components have an essential feel, with soft shapes and oblique lines, balanced out by the strong finishes of the wood or marble bases that connect them up.

De Am Anfang wurden die Felsen von Luft und Wasser geformt, Steinadern, Überlagerungen und perfekte Verbindungen, die von der Natur geschaffen werden. Dann, wenn die organische Form die künstlerische inspiriert, entstehen die Monolithen von Barbara Hepworth und die abstrakten Arbeiten von Serge Poliakoff. Auf dieser Linie bewegt sich das neue Projekt von PearsonLloyd, ein modulares System für Gemeinschaftsräume, das von natürlichen Formen und künstlerischen Impressionen beeinflusst ist. Ischia besteht aus einzelnen Elementen, die beliebig kombinierbar sind: einzel- oder doppelsitzig, mit oder ohne Rückenlehne. Das System kann durch einen kleinen Tisch oder einen Schirm aus Wiener Geflecht zur Trennung oder als Sichtschutz ergänzt werden. Der Schlichtheit der Elemente, geprägt durch weiche Formen und schräge Linien, stehen anspruchsvolle Sockel aus Holz oder Marmor zur Verbindung der Elemente gegenüber.

Fr Au commencement, il y a les roches modelées par l'air et par l'eau, les veines des pierres, les superpositions et les encastements parfaits créés par la nature. Puis, quand la forme organique inspire la forme artistique, naissent les monolithes de Barbara Hepworth et les œuvres abstraites de Serge Poliakoff. C'est dans cette ligne que se place le nouveau projet de PearsonLloyd, un système modulaire influencé par des formes naturelles et des suggestions artistiques, destiné à des espaces collectifs. Ischia est composé d'éléments distincts se composant librement : les éléments d'assise sont simples ou doubles, avec ou sans dossier. Le système offre la possibilité d'ajouter la table basse ou le paravent en cannage, qui sépare et cache. L'aspect essentiel des éléments, caractérisés par des formes douces et des lignes obliques, est équilibré par les finitions importantes des bases en bois ou en marbre qui relient les éléments.



PearsonLloyd

PearsonLloyd is one of the leading names in contemporary British design, and this multidisciplinary studio works in a wide range of sectors: from furnishing to public spaces to brand development. Established by Luke Pearson and Tom Lloyd in 1997, the studio has received numerous acknowledgements and accolades in both Europe and the United States. The British design duo write regularly for major design magazines, as well as acting as "visiting lecturers" at the École Cantonale d'Art in Lausanne.

Other products by PearsonLloyd:
Crystal ⇨ p.098, Crystal (Armchair) ⇨ Vol. B p.108,
Eddy ⇨ Vol. B p.240, Fixie ⇨ Vol. B p.252,
Galleria ⇨ p.148, Nebula (Tacchini Edizioni),
Polar ⇨ p.162, Polar Perch ⇨ p.170, Polar Table ⇨ Vol. B
p.312, Quilt ⇨ p.062, Stone High/Low ⇨ p.180

Technical informations



Modular System, Screen ⇨ p.212, 213

Chill-Out

Il design si fa sistema nel progetto Chill-Out, design Gordon Guillaumier. Geometria lineare e fruibilità multipla danno forma a una creazione componibile e personalizzabile, per dare vita a diversi ambienti in un solo spazio.

Informazioni → p.139



Chill-Out è il sistema di divani e poltrone, completo di tavolini, che costruisce aree di condivisione e relazione dall'estetica ordinata ed elegantemente all'avanguardia, racchiudendo nello spazio individuato la bellezza del disegno e il piacere del comfort. Gli elementi Chill-Out si inseriscono nell'ambiente singolarmente, in composizione lineare o in composizione ad angolo. Il risultato visivo è di grande effetto, grazie alla regolarità ripetuta delle forme, con struttura in metallo e sedute e schienali imbottiti, completata dai raffinati tavolini in marmo di Carrara, Calacatta, Basaltina o Travertino nero, in finitura opaca.

Designer, Year:
Gordon Guillaumier, 2013



Chill-Out (Modular System), base T03 Grey
W 144 D 69 H 71 cm
H seat 44 cm

Chill-Out (Armchair), base T03 Grey
W 74 D 69 H 71 cm
H seat 44 cm

Split (Low Table), top T57 White, base T02 White → Vol. B p.260





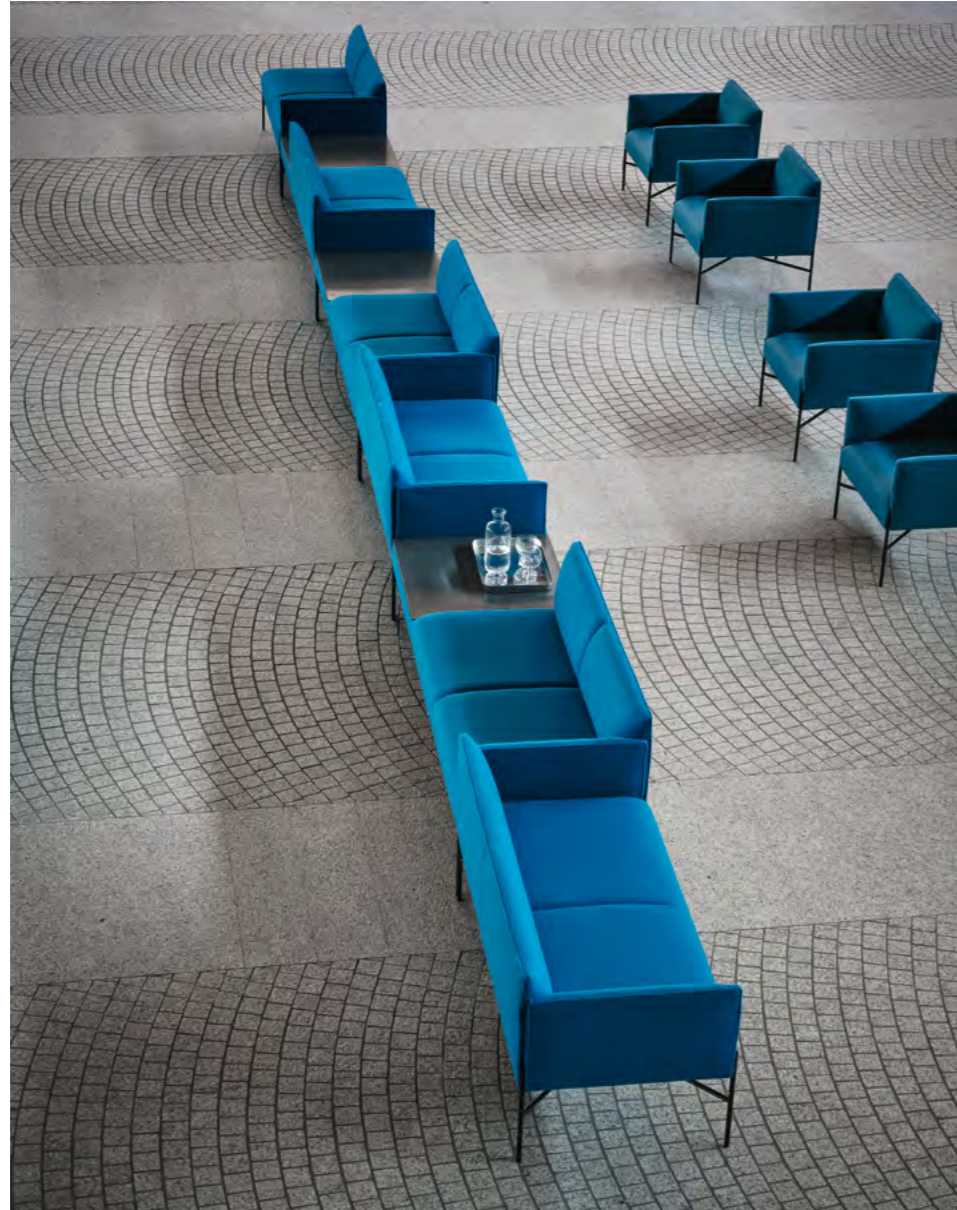

Chill-Out (Modular System),
base T03 Grey, table top
T35 Matt Basaltina Marble
W 144 D 69 H 71 H seat 44 cm

Chill-Out (Armchair),
base T03 Grey
W 74 D 69 H 71 cm
H seat 44 cm

Chill-Out

En Design becomes a system in the Chill-Out project by Gordon Guillaumier. Linear geometries lend themselves to many different uses, shape-shifting into customizable sectional arrangements that can delineate different areas in a single space. Chill-Out is a system of sofas and armchairs, complete with in-line coffee tables, that constructs conversation areas with a businesslike aesthetic that exudes avant-garde elegance, enveloping the space it defines in the beauty of design and the pleasure of comfort. Chill-Out elements can stand alone, in linear arrangements, or be combined in corner sectional layouts. Thanks to the repeated uniformity of the shapes, the visual effect is ensured. The metal structure and upholstered seats and backrests are complemented by elegant coffee tables in Carrara, Calacatta or Basaltina marble or black Travertine with matte finish.

De Das Projekt Chill-Out des Designers Gordon Guillaumier macht Design zu einem System. Eine lineare Geometrie und die vielseitige Nutzung bieten kombinierbare und personalisierbare Gestaltungsmöglichkeiten, mit denen sich unterschiedliche Ambiente im gleichen Raum schaffen lassen. Chill-Out ist ein System mit Sofas, Sesseln und Couchtischen für die Gestaltung gemeinschaftlich genutzter Bereiche, die sich durch ihre geordnete Ästhetik und ihren eleganten und avantgardistischen Charakter auszeichnen und die Schönheit des Designs mit dem Vergnügen des Komforts verbinden. Die Elemente von Chill-Out lassen sich einzeln, in linearen Kombinationen oder in abgewinkelten Kombinationen in den Raum einfügen. Das Ergebnis hat durch die wiederholte Regelmäßigkeit der Formen eine große visuelle Wirkung, die mit den einzelnen Elementen mit Metallgestell und gepolsterten Sitzflächen und Rückenlehnen erzielt wird, in Kombination mit eleganten Couchtischen aus Marmor vom Typ Carrara, Calacatta, Basaltina oder schwarzem Travertino mit matter Oberfläche.

Fr Le design devient système dans le projet Chill-Out, conçu par Gordon Guillaumier. La géométrie linéaire et les multiples possibilités d'utilisation donnent forme à une création modulaire et personnalisable, permettant de créer des zones diverses dans un même espace. Chill-Out est un système de canapés et fauteuils, comprenant également des tables basses, qui construit des espaces de partage et de relation dotés d'une esthétique ordonnée et élégamment novatrice, en délimitant dans l'espace identifié la beauté du dessin et le plaisir du confort. Les éléments Chill-Out s'intègrent de différentes manières dans la pièce : seul, en composition droite ou en composition d'angle. Le résultat visuel est impressionnant grâce à la régularité répétée des formes – avec un piètement métallique et des assises et dossiers rembourrés – que viennent compléter avec raffinement des tables basses en marbre de Carrare, Calacatta, Basaltina ou Travertin noir, en finition mate.



Gordon Guillaumier

Gordon Guillaumier was born in 1966, and was educated firstly in Malta, then in Switzerland, England and Italy. He graduated from IED in Milan (1988-91), before specializing in design at the Domus Academy, Milan (1992). In 1993 he began working with Baleri Associati, as well as collaborating with architect Rodolfo Dordoni. In 2002 he set up his own design studio in Milan, principally working on product design, but also for design consultancy projects. In 2006 he lectured in industrial design at Milan's Politecnico university.

Other products by Gordon Guillaumier:
Cage ⇨ Vol. B p.302, Chill-Out High ⇨ p.140,
Coot ⇨ Vol. B p.308, Face to Face ⇨ p.044,
Ledge ⇨ Vol. B p.316, Soap ⇨ Vol. B p.290,
Spindle ⇨ Vol. B p.274

Technical informations

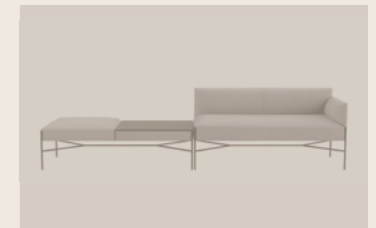

Modular System ⇨ p.207



Low Table ⇨ p.207

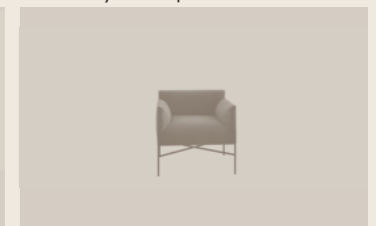

Armchair ⇨ p.207

Chill-Out High

Quando la bellezza è disegnata per superare i limiti, andando oltre gli standard di comfort e funzionalità, per migliorare e ispirare ancora.

Informazioni → p.147

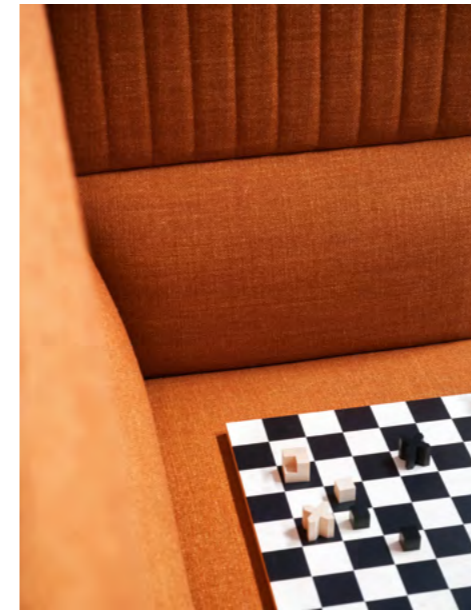

Chill-Out High (Modular System),
base T24 Satin Chrome
W 144 D 69 H 121 H seat 44 cm

Ledge (Low Table), top T31 White
Calacatta Marble, base T24
Satin Chrome → Vol. B p.316

Designer, Year:
Gordon Guillaumier, 2016

Chill-Out High

Chill-Out High di Tacchini propone un inedito sistema di sedute, caratterizzato da schienale imbottito extra alto, accostabile anche a elementi con schienale classico, della stessa collezione. Il piano scrittoio è proposto nelle finiture marmo Basaltina opaco, marmo Carrara opaco o marmo Calacatta lucido.

Awards: 2016 Archiproducts Design Awards



Chill-Out High (Modular System),
base T02 White, table top
T35 Matt Basaltina Marble
W 144 D 69 H 121 H seat 44 cm

Chill-Out (Modular System, Low
Table), base T02 White, table
base T02 White, table top T35 Matt
Basaltina Marble → p.132

Chill-Out High

Kelly C (Chair),
base T02 White
→ Vol. B p.202

Ledge (Low Table), top
T35 Matt Basaltina
Marble, base T02 White
→ Vol. B p.316





Chill-Out High

En When beauty is designed to go beyond the limits, over and above the standards of comfort and functionality, to further improve and inspire. Chill-Out High by Tacchini is a unique seating system, with a super-high padded back, which can be combined with normal-height elements from the same collection. The desk surface is available in the following marble finishes: matt Basaltina, matt Carrara or polished Calacatta.

De Wenn Schönheit geschaffen wird, um Grenzen zu überwinden, für mehr Komfort und Funktion, um Verbesserung und Anregung zu liefern. Chill-Out High von Tacchini sind innovative Sitzmöbel, die in einer extrahohen, gepolsterten Rückenlehne ihr besonderes Merkmal haben. Sie können auch mit Elementen mit klassischer Rückenlehne der gleichen Kollektion kombiniert werden. Die Elemente Chill-Out High zeichnen sich durch ein lineares Design aus und können in jedem Detail bedürfnisgerecht gestaltet werden. Die Schreibplatte wird in den Ausführungen Marmor Basaltina matt, Marmor Carrara matt oder Marmor Calacatta glänzend angeboten.

Fr Quand la beauté est dessinée pour dépasser les limites, en allant au-delà des standards de confort et de fonctionnalité, pour améliorer et inspirer encore et toujours. Le design Chill-Out High de Tacchini propose un système inédit de sièges, caractérisé par un dossier rembourré extra haut, juxtaposable également à des éléments avec dossier classique, de la même collection. Le plateau écritoire est proposé dans les finitions marbre Basaltina mat, marbre Carrara mat ou marbre Calacatta brillant.



Gordon Guillaumier

Gordon Guillaumier was born in 1966, and was educated firstly in Malta, then in Switzerland, England and Italy. He graduated from IED in Milan (1988-91), before specializing in design at the Domus Academy, Milan (1992). In 1993 he began working with Baleri Associati, as well as collaborating with architect Rodolfo Dordoni. In 2002 he set up his own design studio in Milan, principally working on product design, but also for design consultancy projects. In 2006 he lectured in industrial design at Milan's Politecnico university.

Other products by Gordon Guillaumier:
Cage ↪ Vol. B p.302, Chill-Out ↪ p.132, Coot ↪ Vol. B p.308, Face to Face ↪ p.044, Ledge ↪ Vol. B p.316, Soap ↪ Vol. B p.290, Spindle ↪ Vol. B p.274

Technical informations

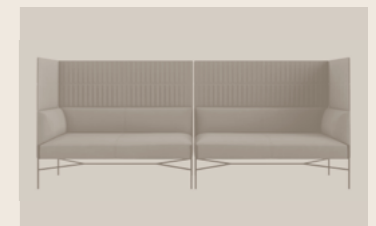

Modular System ↪ p.208

Chill-Out High (Modular System),
base T02 White
W 144 D 69 H 121 H seat 44 cm

Ledge (Low Table), top
T31 White Calacatta
Marble, base T02 White
↪ Vol. B p.316

Galleria

Galleria è un progetto completo che consente di creare le più svariate soluzioni: panca lineare, seduta angolare doppia, isola dedicata all'attesa, al relax o alla convivialità.

Informazioni → p.161



Designer, Year:
PearsonLloyd, 2013

Tutto questo partendo da una semplice barra d'acciaio, sulla quale si agganciano liberamente elementi dalle forme geometriche semplici in legno, pelle, tessuto, marmo e metallo verniciato in diversi colori. Ogni composizione può essere utilizzata da sola oppure in gruppi, moltiplicando all'infinito le possibilità d'uso e armonizzandosi con qualsiasi spazio o stile.

Awards: Interior Innovation Awards 2014



Galleria S-Shape (Modular System),
frame T49 Grey, base
T03 Grey, table top T03 Grey
W 400 D 250 H 42 cm





Galleria Double (Modular System),
frame T45 Natural, base T02 White
Ash, table top T02 White
W 300 D 98 H 42 cm



Galleria (Modular System),
frame T45 Natural, base T02 White
Ash, occasional side table top
T30 Matt White Carrara Marble



Galleria B (Modular System), frame T45 Natural
Ash, base T02 White, table top T02 White, occasional
side table top T30 Matt White Carrara Marble
W 250 D 250 H 42 cm



Galleria



Galleria Double (Modular System),
frame T45 Natural Ash, base T02
White, table top T02 White
W 300 D 98 H 42 cm



Galleria Shear (Modular System),
frame T45 Natural Ash, base T02
White, table top T02 White
W 400 D 98 H 42 cm

Galleria

En Galleria is a complete design with the versatility to create a vast range of different solutions: a linear bench, a double corner seat, an island perfect for waiting, relaxation and conviviality. And all this is developed around a simple steel bar, onto which to freely attach the various simple, geometrically-shaped elements in wood, leather, fabric, marble and metal painted in a range of colours. Each composition can be used on its own or in groups, offering endless possibilities for use that will blend beautifully with any space or style.

De Galleria ist ein komplettes Angebot für unterschiedlichste Lösungen: gerade Sitzbänke, doppelte Eckbank, Sitzinsel für den Wartebereich, zum Relaxen, für kollektive Räume. All das geht von einer einfachen Stahlschiene aus, in die Elemente in schlichten, geometrischen Formen aus Holz, Leder, Stoff, Marmor oder Metall in verschiedenfarbiger Lackierung einhängbar sind. Jede Kombination kann einzeln oder in Gruppen eingesetzt werden, um die Möglichkeit ihrer Nutzung vielfach zu erweitern und harmonisch auf jeden Raum und Einrichtungsstil abzustimmen.

Fr Galleria est un projet complet qui permet de créer les solutions les plus variées : une banquette linéaire, une banquette d'angle double, un îlot consacré à l'attente, à la détente ou à la convivialité. Tout cela en partant d'une simple barre d'acier, sur laquelle on accroche librement des éléments de formes géométriques simples réalisés dans des matériaux riches de personnalité : bois, cuir, tissu et métal laqué en différentes couleurs. Chaque composition peut être utilisée seule ou en groupes, en multipliant pratiquement à l'infini les possibilités d'emploi et en s'harmonisant avec n'importe quel espace ou style.



PearsonLloyd

PearsonLloyd is one of the leading names in contemporary British design, and this multidisciplinary studio works in a wide range of sectors: from furnishing to public spaces to brand development. Established by Luke Pearson and Tom Lloyd in 1997, the studio has received numerous acknowledgements and accolades in both Europe and the United States. The British design duo write regularly for major design magazines, as well as acting as "visiting lecturers" at the École Cantonale d'Art in Lausanne.

Other products by PearsonLloyd:
Crystal ⇨ p.098, Crystal (Armchair) ⇨ Vol. B p.108,
Eddy ⇨ Vol. B p.240, Fixie ⇨ Vol. B p.252,
Ischia ⇨ p.124, Nebula (Tacchini Edizioni),
Polar ⇨ p.162, Polar Perch ⇨ p.170, Polar Table ⇨ Vol. B
p.312, Quilt ⇨ p.062, Stone High/Low ⇨ p.180

Technical informations

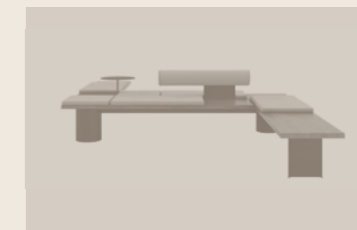

Modular System ⇨ p.209

Polar

Polar è un sistema di sedute ispirato ai blocchi di ghiaccio dei mari del Nord.

Informazioni → p.169



Gli elementi che lo compongono sono caratterizzati da volumi pieni e tagli obliqui e si possono combinare tra loro per creare divani e poltrone, con o senza schienale. Versatile, accogliente e di grande impatto estetico, il sistema si completa con il tavolino Polar.

Designer, Year:
PearsonLloyd, 2006









Polar (Modular System)
W 234 D 107 H 73 cm
H seat 37 cm

Polar (Armchair)
W 107 D 81,5 H 67 cm
H seat 37 cm

Polar Table (Low
Table), finish T21 White
⇒ Vol. B p.312

Polar

En Polar is a seating system inspired by the icebergs of the northern seas. Its components all feature solid volumes and oblique lines, which can be combined to create sofas and armchairs, with or without backrests. Versatile, cosy and aesthetically striking, the system is perfectly complemented by Polar coffee table.

De Polar ist ein modulares System von Sitzelementen, die sich von der Form der Eisblöcke in den nördlichen Meeren anregen lassen. Die einzelnen Elemente – mit charakteristischen, vollen Volumen und schrägen Kanten – können beliebig zu Sofas oder Fauteuils mit oder ohne Rückenlehne kombiniert werden. Vielseitig, bequem und optisch sehr effektiv, wird das System durch ein Tischchen ergänzt.

Fr Polar est un système de sièges s’inspirant des blocs de glace des mers du Nord. Les éléments qui le composent sont caractérisés par des volumes pleins et des coupes obliques et peuvent se combiner entre eux pour créer des canapés et des fauteuils, avec ou sans dossier. Polyvalent, accueillant et d’un grand effet esthétique, le système est complété par la table basse Polar.



PearsonLloyd

PearsonLloyd is one of the leading names in contemporary British design, and this multidisciplinary studio works in a wide range of sectors: from furnishing to public spaces to brand development. Established by Luke Pearson and Tom Lloyd in 1997, the studio has received numerous acknowledgements and accolades in both Europe and the United States. The British design duo write regularly for major design magazines, as well as acting as “visiting lecturers” at the École Cantonale d’Art in Lausanne.

Other products by PearsonLloyd:
Crystal ⇒ p.098, Crystal (Armchair) ⇒ Vol. B p.108,
Eddy ⇒ Vol. B p.240, Fixie ⇒ Vol. B p.252,
Galleria ⇒ p.148, Ischia ⇒ p.124, Nebula (Tacchini
Edizioni), Polar Perch ⇒ p.170, Polar Table ⇒ Vol. B
p.312, Quilt ⇒ p.062, Stone High/Low ⇒ p.180

Technical informations

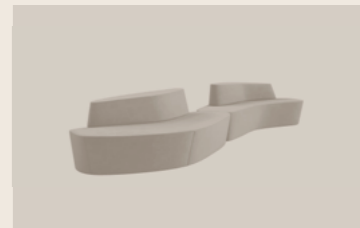

Modular System ⇒ p.214



Armchair ⇒ p.214

Polar Perch

Un progetto creativo dalle molteplici visioni, che interpreta con intelligenza e originalità le esigenze di un vivere contemporaneo sempre più mobile e multiforme.

Informazioni → p.179

Polar Perch, design by PearsonLloyd, è costituito dall'accostamento di due elementi dalle morbide linee curve e diverse altezze, che si compongono a coppie complementari. Mentre l'elemento più basso, singolo e autonomo, presenta la funzione di seduta, quello più alto, in abbinamento, è utilizzabile come suo schienale, seconda seduta alta o piano di appoggio. Il design fortemente innovativo di questi elementi componibili permette di creare inedite forme di grande impatto estetico, con soluzioni personalizzabili per i diversi contesti di inserimento.

Designer, Year:
PearsonLloyd, 2013











Polar Perch (Modular System)
W 220 D 79 H 70 H seat 70 cm
/W 207 D 84,5 H 46 H seat 46 cm

Polar (Modular System)
⇒ p.162

Polar Perch

En An ingenious design with many different perspectives, it intelligently interprets the uniqueness and needs of an increasingly mobile and multi-faceted contemporary lifestyle. Polar Perch, designed by PearsonLloyd, consists of the pairing of two softly curved elements of different heights that form complementary pairs. While the individual, stand-alone lower element functions as a seat, the higher piece, when paired with it, becomes a backrest, or additional higher bench seating, or a table-top surface. The innovative design of these modular pieces means they can be arranged to create unusual shapes of amazing aesthetic impact with customizable solutions for various types of settings.

De Ein kreatives Projekt mit umfassenden Visionen, das den Anspruch eines modernen und zunehmend mobileren und vielseitigeren Lebensstils mit Intelligenz und Originalität interpretiert. Polar Perch vom Designstudio PearsonLloyd ist die Kombination zweier Elemente mit weichen, geschwungenen Linien und unterschiedlicher Höhe, die paarweise gruppiert werden und sich gegenseitig ergänzen. Das niedrigere Element ist eine einzelne und eigenständige Sitzbank und kann mit dem höheren Element kombiniert werden, das als Rückenlehne, als eine zweite höhere Sitzbank oder als Ablage fungiert. Das extrem innovative Design dieser kombinierbaren Elemente erlaubt die Gestaltung einzigartiger Formen mit großer ästhetischer Wirkung und das Schaffen personalisierbarer Lösungen für die unterschiedlichsten Anwendungsbereiche.

Fr Ce projet créatif aux visions multiples interprète les besoins d'une vie contemporaine, de plus en plus mobile et multiforme, avec intelligence et originalité. Conçu par PearsonLloyd, Polar Perch est la combinaison de deux éléments aux lignes courbes et douces, de hauteurs différentes, qui composent des paires complémentaires. Alors que l'élément le plus bas, individuel et autonome, assure la fonction d'assise, le plus haut peut y être associé comme dossier ou seconde assise haute, voire comme surface pour poser des objets. Le design hautement innovant de ces éléments modulaires permet de créer des formes inédites d'un grand impact esthétique, offrant des solutions personnalisables en fonction du contexte où il doit s'intégrer.



PearsonLloyd

PearsonLloyd is one of the leading names in contemporary British design, and this multidisciplinary studio works in a wide range of sectors: from furnishing to public spaces to brand development. Established by Luke Pearson and Tom Lloyd in 1997, the studio has received numerous acknowledgements and accolades in both Europe and the United States. The British design duo write regularly for major design magazines, as well as acting as "visiting lecturers" at the École Cantonale d'Art in Lausanne.

Other products by PearsonLloyd:
Crystal ⇒ p.098, Crystal (Armchair) ⇒ Vol. B p.108,
Eddy ⇒ Vol. B p.240, Fixie ⇒ Vol. B p.252,
Galleria ⇒ p.148, Ischia ⇒ p.124, Nebula (Tacchini
Edizioni), Polar ⇒ p.162, Polar Table ⇒ Vol. B p.312,
Quilt ⇒ p.062, Stone High/Low ⇒ p.180

Technical informations

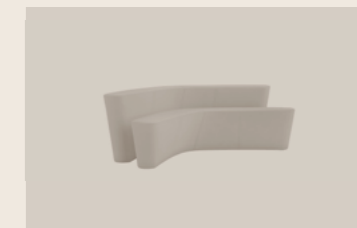

Modular System ⇒ p.214

Stone High/Low

Il fascino delle forme scolpite dalla natura, incredibilmente tradotto in morbide sedute componibili caratterizzate da linee rotonde essenziali e perfettamente armoniose nella creativa progettualità dell'insieme.

Informazioni → p.189



Stone è un sistema di divani pensato in chiave modulare, per disegnare infinite possibilità compositive di grande impatto estetico, dedicate agli spazi pubblici e contract di varie dimensioni. L'immagine delle pietre levigate dall'acqua e dal tempo ha ispirato i designer PearsonLloyd, che ha dato forma a elementi d'arredo che trovano la loro più alta espressione nella modularità della composizione, che lascia spazio alla fantasia, accompagnandola con qualità e funzione. Grazie alla struttura metallica, elegantemente sottile e discreta, disponibile in due diverse altezze, i divani Stone si adattano perfettamente sia a sale d'attesa e spazi relax, che agli ambienti dedicati alla ristorazione, come caffetterie, lounge e ristoranti.

Designer, Year:
PearsonLloyd, 2009

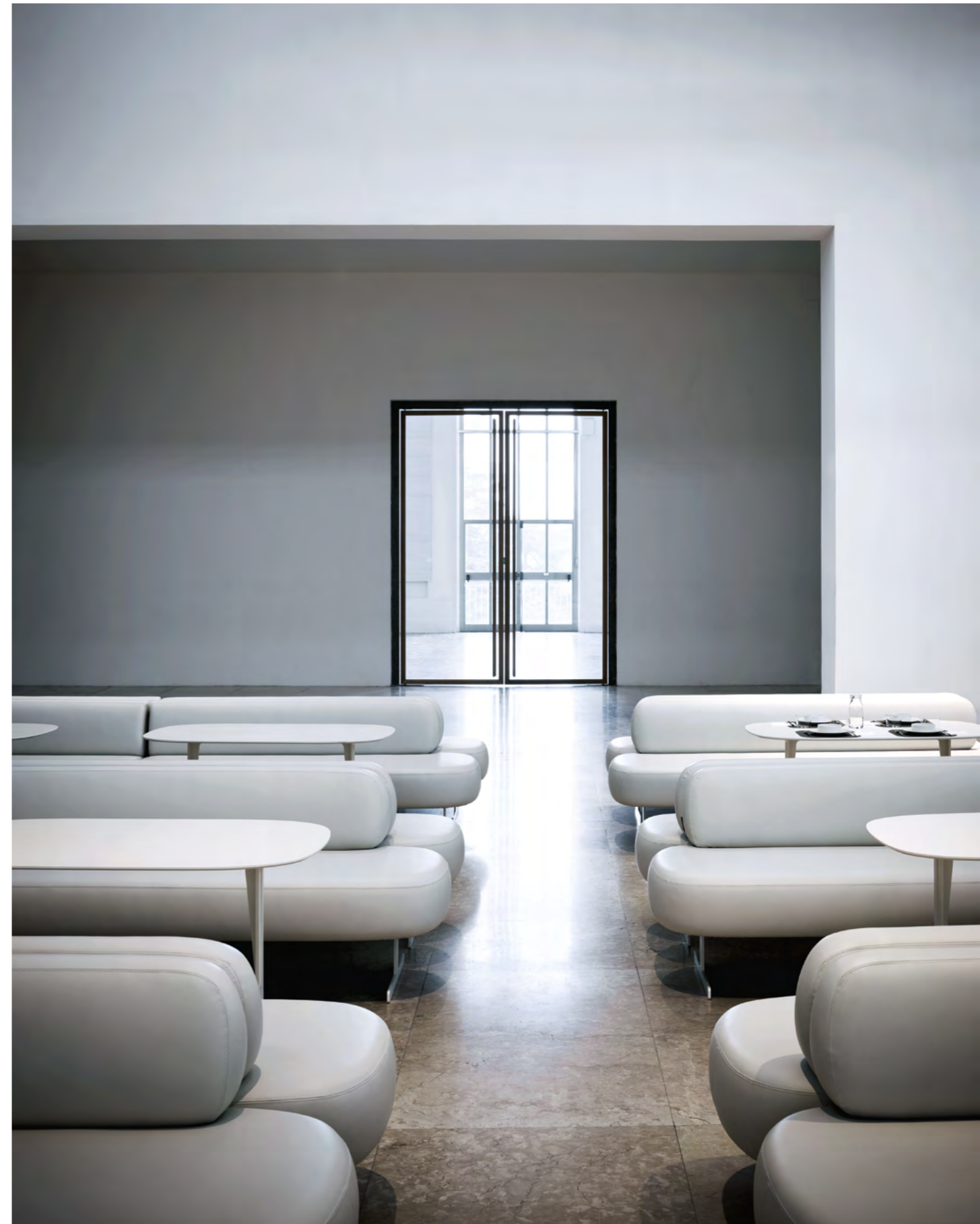

IL COMUNE DI MILANO
TRADOTTA IN ATTO LA VOLONTA' DEL MUNIFICO DONATORE COL
GENEROSO CONCORSO DEI FRATELLI MICHELE E ANDREA BERNOCCHI
DEDICA QUESTO PALAZZO DELL' ARTE
ANNO MCMXXXIII



Stone High (Modular System), base T07 Black
W 200 D 73 H 77 cm
H seat 45 cm



Stone Low (Modular System), base T07 Black
W 200 D 73 H 68 cm
H seat 39 cm





Stone Low (Modular System),
base T02 White
W 238 D 112 H 68 H seat 39 cm

Polar Table (Low Table),
finish T22 Yellow ⇒ Vol. B p.312

Stone High/Low

En The dramatic allure of shapes sculpted by nature, unbelievably transformed into modular seating elements featuring sleek, rounded lines beautifully balanced within the overall creative design concept. Stone is a modular sofa system crafted to unfold infinite possibilities of arrangement with dramatic aesthetic impact, catering to public and contract spaces of all different sizes. The look and feel of stones worn smooth in water over time inspired designer PearsonLloyd, who shaped seating elements that find their highest expression in the modularity of arrangement options that set the imagination free but remain a steadfast ally in terms of quality and functionality. The elegantly slender and discreet metal structure, available in two different heights, ensures the Stone sofas fit perfectly in waiting rooms and leisure spaces, as well as in dining establishments like cafes, lounges and restaurants.

De Die Faszination der von der Natur hervorgebrachten Formen wurde auf einzigartige Weise mit weichen, kombinierbaren Sitzelementen mit minimalistischen runden Linien umgesetzt, die perfekt mit dem kreativen Design des Gesamtbildes harmonisieren. Stone ist ein modulares Sofasystem, das zahllose Gestaltungsmöglichkeiten mit großer ästhetischer Wirkung bietet und für öffentliche Räume und Objekteinrichtungen unterschiedlicher Größe geeignet ist. Das Bild der Steine, die vom Wasser und der Zeit glatt geschliffen worden sind, hat das Designstudio PearsonLloyd dazu inspiriert, Einrichtungselemente zu schaffen, deren Ausdruckskraft durch die Modularität der Kombination zum Tragen kommt. So wird der Phantasie Raum gegeben und die Idee mit Qualität und Funktionalität umgesetzt. Mit ihrem eleganten und diskreten, schmalen Metallgestell, das in zwei Höhen verfügbar ist, passen die Sofas Stone perfekt sowohl in Wartebereiche als auch in Entspannungsbereiche und eignen sich auch für die Gaststättengewerbe, wie Cafeterias, Lounges und Restaurants.

Fr Le charme des formes sculptées par la nature, prodigieusement traduit en sièges moelleux et modulables qui se démarquent par des lignes courbes épurées et parfaitement harmonieuses dans l'élaboration projectuelle de l'ensemble. Stone est un système de canapés conçu dans un esprit modulaire, afin de dessiner des possibilités de composition infinies d'un grand impact esthétique, dédiées aux espaces publics et collectifs de différentes tailles. Le duo PearsonLloyd s'est inspiré de l'image des pierres polies par l'eau et le temps pour donner forme à des éléments d'ameublement qui s'expriment à merveille dans des compositions modulaires laissant libre cours à l'imagination, tout en l'accompagnant avec qualité et fonction. Grâce à la structure métallique, élégamment mince et discrète, disponible en deux hauteurs différentes, les canapés Stone sont parfaitement adaptés à la fois aux salles d'attente et aux espaces de détente, ainsi qu'aux salles dédiées à la restauration, telles que cafétérias, lounge et restaurants.



PearsonLloyd

PearsonLloyd is one of the leading names in contemporary British design, and this multidisciplinary studio works in a wide range of sectors: from furnishing to public spaces to brand development. Established by Luke Pearson and Tom Lloyd in 1997, the studio has received numerous acknowledgements and accolades in both Europe and the United States. The British design duo write regularly for major design magazines, as well as acting as "visiting lecturers" at the École Cantonale d'Art in Lausanne.

Other products by PearsonLloyd:
Crystal ⇒ p.098, Crystal (Armchair) ⇒ Vol. B p.108,
Eddy ⇒ Vol. B p.240, Fixie ⇒ Vol. B p.252,
Galleria ⇒ p.148, Ischia ⇒ p.124, Nebula (Tacchini Edizioni), Polar ⇒ p.162, Polar Perch ⇒ p.170,
Polar Table ⇒ Vol. B p.312, Quilt ⇒ p.062

Technical informations

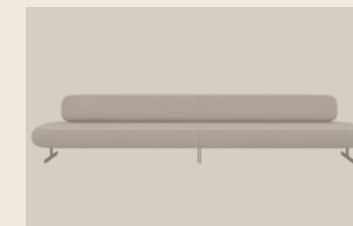

Modular System ⇒ p.214

Intercity

Intercity è un sistema componibile che permette di creare spazi a misura di qualsiasi ambiente ed esigenza.

Informazioni → p.199



La scelta di moduli base è ampia e comprende elementi imbottiti con o senza schienale, sia lineari che curvi. Le sedute lineari, anche con tavolino integrato in marmo di Carrara opaco o Basaltina, si possono accostare a piacimento per comporre diverse soluzioni, anche le più particolari, come quelle rese possibili dall'elemento con schienale a forma di esse, che crea una seduta bifacciale, o dagli elementi con sedute "face to face". Grazie ai moduli curvi si realizzano anche composizioni ad arco oppure a isola. Completa il sistema di sedute il pouf rotondo, con o senza piano in marmo inserito.

Designer, Year:
Pietro Arosio, (1999) 2018





Intercity (Ottoman), table top
T30 Matt White Carrara Marble
Ø 150 H 40 cm



Intercity (Modular System), base T23
Polished Chrome, feet T03 Grey



Intercity (Modular System), base T23
Polished Chrome, feet T03 Grey,
table top T35 Matt Basaltina Marble
W 180 D 75 H 73 H seat 40 cm



Intercity (Modular System), base T23
Polished Chrome, feet T03 Grey,
table top T35 Matt Basaltina Marble
W 150 D 75 H 73 H seat 40 cm



Intercity (Modular System), base T23
Polished Chrome, feet T03 Grey,
table top T30 Matt White Carrara Marble

Intercity

En Intercity is a modular system for creating spaces tailored to any room and need. The wide choice of base modules includes upholstered elements with or without back, both straight and curved. The straight seats, also with integrated side table in matte Carrara marble or Basaltina, can be combined as preferred to compose different solutions, even the most unusual ones, such as those made possible by the module with S-shaped back which creates a double-sided seat, or by the modules with "face-to-face" seats. Arch or island compositions can be created thanks to the curved modules. The seating system also includes a round pouf, with or without integrated top in marble.

De Intercity ist ein zusammenstellbares Einrichtungssystem, mit dem Räume nach Maß für jedes Ambiente und Bedürfnis gestaltet werden können. Die umfangreiche Auswahl an Grundmodulen enthält gepolsterte Elemente mit oder ohne Rückenlehne, in gerader oder runder Form. Die geraden Sitzmöbel, in die auch Ablagen aus Carrara-Marmor matt oder Basaltina integrierbar sind, können unterschiedliche Lösungen ergeben. Sehr speziell die doppelseitige Zusammenstellung dank Rückenlehne in S-Form, oder die Elemente mit Sitzflächen „face-to-face“. Die runden Module können zu bogenförmigen Kompositionen oder Sitz-Inseln verbunden werden. Ein runder Hocker, mit oder ohne Marmorplatte, komplettiert das Einrichtungssystem.

Fr Intercity est un système modulaire qui permet de créer espaces adaptés à n'importe quel environnement et exigence. Il dispose d'un vaste choix de modules de base et comprend des éléments rembourrés avec ou sans dossier, linéaires ou courbes. Les banquettes linéaires, également avec table basse incorporée en marbre de Carrare mat ou Basaltina, peuvent être juxtaposées à volonté pour créer différentes solutions, même les plus particulières, comme celles rendues possibles par l'élément avec dossier en forme de « S », qui crée une banquette biface, ou par les éléments avec assises vis à vis. Grâce aux modules courbes, il est possible de réaliser également des compositions en arc de cercle ou en îlot. Le système est complété par un pouf rond, avec ou sans plateau en marbre inséré.



Pietro Arosio

Pietro Arosio was born in 1946 in Lissone, near Milan. He learnt his profession at the research centre of a company specialising in the production of metal furniture for communal spaces. This experience led to the emergence of a design philosophy that developed over time through his work as an industrial designer. He began his career in 1972, and was already winning accolades in 1983, receiving the Casaviva d'Oro award. The fundamentals of his work include essentiality, research into new materials and technologies, and attention to detail and to the engineering implications of his designs. Pietro Arosio is fully aware of the emotional impact his products can have, and has worked in partnership with various internationally-acclaimed artists, including Nespolo, Del Pezzo, Hsiao Chin, Tilson, Rotella and Keizo. A number of his pieces have been exhibited at the Victoria and Albert Museum in London, and at the Munich modern art museum Die Sammlung.

Other products by Pietro Arosio:
Moon ⇨ Vol. B p.144, Parentesi ⇨ Vol. B p.132,
Quadro ⇨ p.084, Slalom ⇨ Vol. B p.192,
Sliding ⇨ p.112, XL ⇨ Vol. B p.162

Technical informations



Modular System ⇨ p.210, 211



La collezione e i progetti Tacchini non si fermano alla produzione e ai suoi processi. La storia di questa famiglia, e dell'azienda che ne porta il nome, si intreccia con la storia del design italiano e internazionale: ogni capitolo è stato scritto con cura e attenzione per il dettaglio, e ogni oggetto traduce queste passioni.

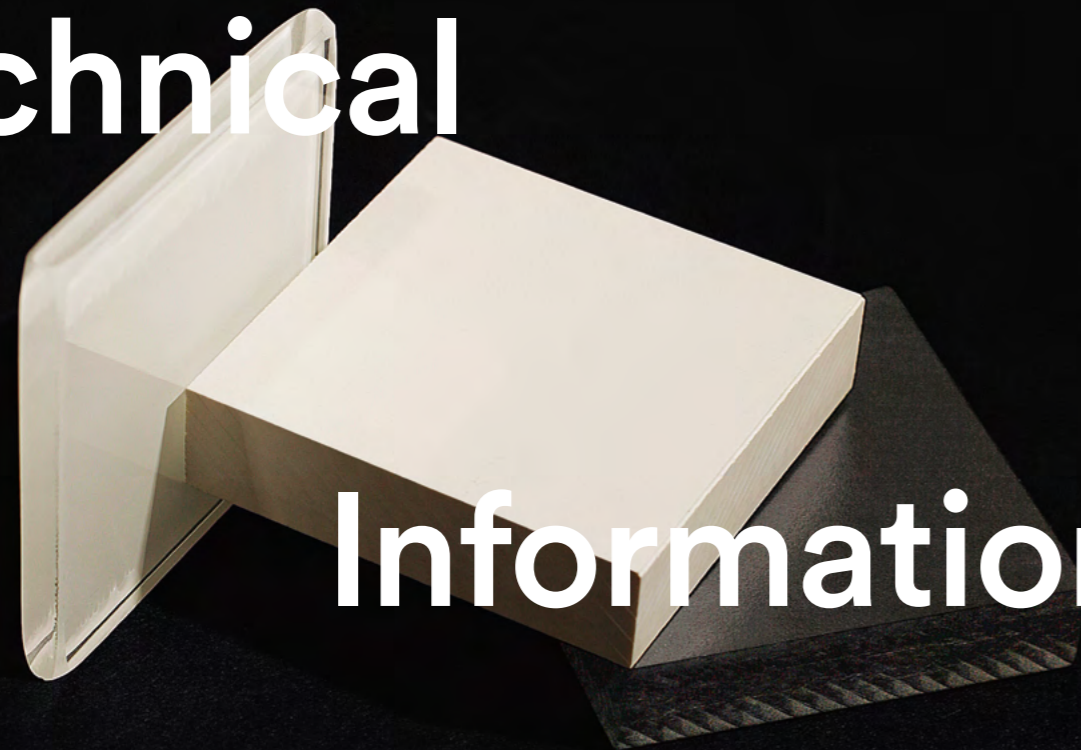



Technical Informations

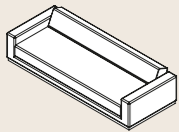
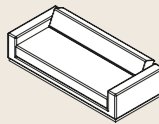

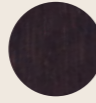

The Tacchini collection and designs are about more than just production and processes. The history of this family, and of the company that bears its name, is interwoven with the history of Italian and international design: each chapter was written with care and attention to detail, and each product reflects this passion.





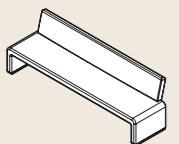
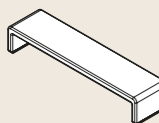
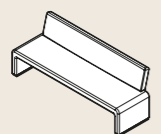
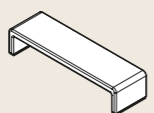
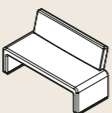
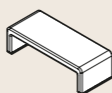

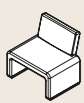

| | | | | | | |
|------------------------------------------------------------------------|------------------------------------------------|-----------------------------------------------------|---------------------------------------------------------------------------------------------|---------------------------------------------------------------------------------------|-------------------------------------------------------------------------------------|--------------------------------------------------------------------------------------------|
| Crystal | by PearsonLloyd | | | Sofa, Armchair | Non-removable covers | |
| | | | | | | |
| OCRY213 W 213 D 85 H 68 cm Seat H 46 cm | OCRY153 W 153 D 85 H 68 cm Seat H 46 cm | OCRY96/OCRYG96 W 96 D 80 H 68 cm Seat H 43 cm | Base Base fissa (OCRY96) o girevole (OCRYG96) Fixed (OCRY96) or swivel (OCRYG96) base | | | Mit fixer (OCRY96) oder Drehgestell (OCRYG96) Base fixe (OCRY96) ou pivotante (OCRYG96) |
| Dressed | by Luca Nichetto | | | Sofa | Removable covers Not feasible in Super Leather and Aniline Leather | |
| | | | | | | |
| ODRES220 W 220 D 88 H 81 cm Seat H 40 cm | ODRES175 W 175 D 88 H 81 cm Seat H 40 cm | | | | | |
| | | | | | | |
| | T02 RAL 9016 | T07 RAL 9011 | | | | |
| Base verniciata Painted base Gestell lackiert Piétement laqué | Bianco White Weiss Blanc | Nero Black Schwarz Noir | Cerniera Zip Reißverschluss Fermeture éclair | Bianco White Weiss Blanc | Nero Black Schwarz Noir | |
| Face to Face | by Gordon Guillaumier | | | Sofa | Non-removable covers | |
| | | | | | | |
| OFAC196 W 196 D 97 H 73,5 cm Seat H 38 cm | | | | | | |
| | | | | | | |
| | T02 RAL 9016 | T03 RAL 7016 | T25 | T27 | | |
| Base verniciata Painted base Gestell lackiert Piétement laqué | Bianco White Weiss Blanc | Grigio Grey Gru Gris | Base cromata Chromed base Gestell verchromt Piétement chromé | Oro Champagne Opaco Matt Champagne Gold Matt Champagne Gold Or Champagne Mat | Cromo Nero Opaco Matt Black Chromed Matt Schwarz Verchromt Chrome Noir Mat | |
| | | | | | | |
| | T77 | T78 | T79 | T80 | T81 | |
| Cucitura punto croce: colore filati Cross-stitched seam: yarn color | | | | | | |
| | | | | | | |
| | T82 | | | | | |

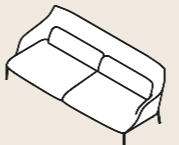







| | | | | |
|----------------------------------------------------------------------------------|-----------------------------------------------------------------------------------|-----------------------------------------------------------------------------------|-----------------------------------------------------------------------------------|-------------------------|
| Havana | by Lievore Altherr Molina | | Sofa, Sofa Bed | Removable covers |
|  |  | | | |
| OHAV255 W 255 D 102 H 69 cm Seat H 38 cm | OHAV225 W 225 D 102 H 69 cm Seat H 38 cm | | | |
| |  |  |  | |
| Base Base Gestell Piétement | Alluminio Aluminium Aluminium Aluminium | Alluminio Lucido Gloss Aluminium Aluminium Glänzend Aluminium Brillant | Wengè Wengè Wengè Wengè | |

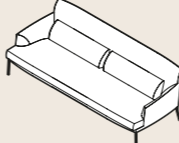
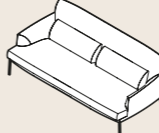
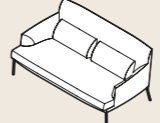

| | | | | |
|----------------------------------------------------------------------------------|-----------------------------------------------------------------------------------|-----------------------------------------------------------------------------------|-----------------------------------------------------------------------------------|-----------------------------|
| Julep | by Jonas Wagell | | Sofa, Armchair, Ottoman, Chaise-longue | Non-removable covers |
|  |  |  |  | |
| OJUL240 W 240 D 126 H 75 cm Seat H 42 cm | OJUL102 W 102,5 D 87,5 H 75 cm Seat H 42 cm | OJULP68 W 68 D 66 H 42 cm Seat H 42 cm | OJUL174 W 174 D 137 H 75 cm Seat H 42 cm | |
| | | | | |



| | | | | | | | |
|------------------------------------------------------------------------------------|-------------------------------------------------------------------------------------|-------------------------------------------------------------------------------------|-------------------------------------------------------------------------------------|---------------------------------------------------------------------------------------|---------------------------------------------------------------------------------------|-----------------------|-----------------------------|
| Labanca | by Lievore Altherr Molina | | | | | Sofa, Armchair | Non-removable covers |
|  |  |  |  |  |  | | |
| OLABD240 W 240 D 62 H 74 cm Seat H 39,5 cm | OLABP240 W 240 D 62 H 39,5 cm Seat H 39,5 cm | OLABC200 W 200 D 62 H 74 cm Seat H 39,5 cm | OLABP200 W 200 D 62 H 39,5 cm Seat H 39,5 cm | OLABB140 W 140 D 62 H 74 cm Seat H 39,5 cm | OLABP140 W 140 D 62 H 39,5 cm Seat H 39,5 cm | | |
| | | | | | | | |

| | | | | | | | |
|------------------------------------------------------------------------------------|-------------------------------------------------------------------------------------|--|--|--|--|--|--|
|  |  | | | | | | |
| OLABA80 W 80 D 62 H 74 cm Seat H 39,5 cm | OLABP80 W 80 D 62 H 39,5 cm Seat H 39,5 cm | | | | | | |
| | | | | | | | |

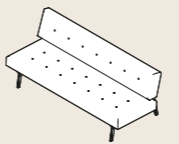

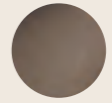
| | | | | | |
|-------------------------------------------------------------------------------------|-------------------------------------------------------------------------------------|-------------------------------------------------------------------------------------|-------------------------------------------------------------------------------------|-------------------------------------------------------------------------------------|-----------------------------|
| Lima | by Claesson Koivisto Rune | | | Sofa, Armchair, Ottoman | Non-removable covers |
|  |  |  |  |  | |
| OLIM213 W 218 D 91 H 78,5 cm Seat H 39,5 cm | OLIM183 W 188 D 91 H 78,5 cm Seat H 39,5 cm | OLIM153 W 158 D 91 H 78,5 cm Seat H 39,5 cm | OLIM89 W 89 D 91 H 78,5 cm Seat H 39,5 cm | OLIM70 W 89 D 70 H 39,5 cm Seat H 39,5 cm | |
| |  |  |  | | |
| Base verniciata Painted base Gestell lackiert Piétement laqué | Bianco White Weiss Blanc | Nero Black Schwarz Noir | Marrone Brown Braun Brun | | |

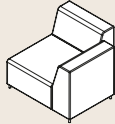
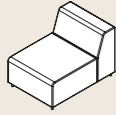

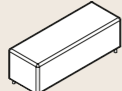
| | | | | | |
|-------------------------------------------------------------------------------------|---------------------------------------------------------------------------------------|---------------------------------------------------------------------------------------|---------------------------------------------------------------------------------------|---------------------------------------------------------------------------------------|---------------------------------------------------------------------------------------|
| Montevideo | by Claesson Koivisto Rune | | | Sofa, Armchair, Ottoman, Chair | Removable covers |
|  |  |  |  |  |  |
| OMON222 W 222 D 90 H 78 cm Seat H 40 cm | OMON192 W 192 D 90 H 78 cm Seat H 40 cm | OMON162 W 162 D 90 H 78 cm Seat H 40 cm | OMON96 W 96 D 90 H 78 cm Seat H 40 cm | OMON93 W 93 D 71 H 40 cm Seat H 40 cm | OMON54 W 54 D 62 H 80 cm Seat H 47 cm |
| |  |  |  |  |  |
| Base verniciata Painted base Gestell lackiert Piétement laqué | Bianco White Weiss Blanc | Nero Black Schwarz Noir | Marrone Brown Braun Brun | Metalgrey Metalgrey Metalgrey Metalgrey | Bronzo Bronze Bronze Bronze |

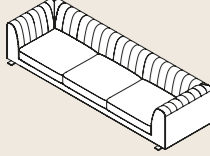
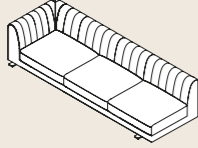
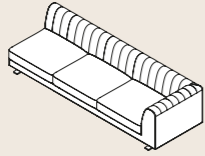
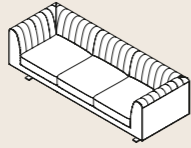
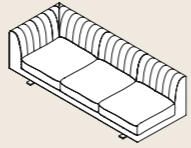
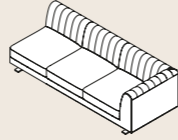

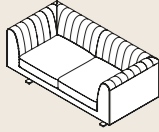
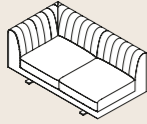
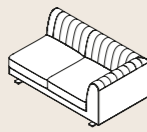
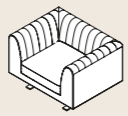
| | | | | | |
|---------------------------------------------------------------------------------------|---------------------------------------------------------------------------------------|---------------------------------------------------------------------------------------|-------------|---------------------------------------------------------------------------------------|-----------------------------|
| Oliver | by Gianfranco Frattini | | Sofa | Design Classic | Non-removable covers |
|  | | | | | |
| OOLIV190 W 190 D 83,5 H 77 cm Seat H 40 cm | | | | | |
| |  |  | |  | |
| Base verniciata Painted base Gestell lackiert Piétement laqué | Bianco White Weiss Blanc | Nero Black Schwarz Noir | | Cromo Nero Opaco Matt Black Chromed Matt Schwarz Verchromt Chrome Noir Mat | |





| | | | | |
|----------------------------------------------------------------------------------|-----------------------------------------------------------------------------------|-----------------------------------------------------------------------------------|-----------------------------------------------------------------------------------|-------------------------|
| Quadro | by Pietro Arosio | | Sofa, Armchair, Ottoman | Removable covers |
|  |  |  |  | |
| OQA100 W 98 D 98 H 66 cm Seat H 36 cm | OQB70 W 70 D 98 H 66 cm Seat H 36 cm | OQD70 W 70 D 70 H 36 cm Seat H 36 cm | OQE35 W 98 D 35 H 36 cm Seat H 36 cm | |

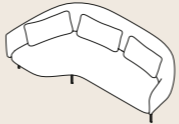

| | | | | | |
|----------------------------------------------------------------------------------|-----------------------------------------------------------------------------------|-----------------------------------------------------------------------------------|-----------------------------------------------------------------------------------|-------------------------------------------------------------------------------------|-------------------------------------------------------------------------------------|
| Quilt | by Pearson Lloyd | | Sofa, Armchair, Ottoman | | Removable covers |
|  |  |  |  |  |  |
| OQUI260 W 260 D 80 H 68 cm Seat H 41 cm | OQUM240 W 240 D 80 H 68 cm Seat H 41 cm | OQUL240 W 240 D 80 H 68 cm Seat H 41 cm | OQUF220 W 220 D 80 H 68 cm Seat H 41 cm | OQUH200 W 200 D 80 H 68 cm Seat H 41 cm | OQUG200 W 200 D 80 H 68 cm Seat H 41 cm |

| | | | | | |
|----------------------------------------------------------------------------------|-----------------------------------------------------------------------------------|-----------------------------------------------------------------------------------|-----------------------------------------------------------------------------------|-------------------------------------------------------------------------------------|--|
|  |  |  |  |  | |
| OQUC160 W 160 D 80 H 68 cm Seat H 41 cm | OQUE140 W 140 D 80 H 68 cm Seat H 41 cm | OQUD140 W 140 D 80 H 68 cm Seat H 41 cm | OQUB100 W 100 D 80 H 68 cm Seat H 41 cm | OQUN80 W 80 D 80 H 41 cm Seat H 41 cm | |

| | | | | | |
|---------------------------------------------|-------------------------------------------------------------------------------------|-------------------------------------------------------------------------------------|--|--|--|
| |  |  | | | |
| | T03 | T23 | | | |
| Base Base Gestell Piétement | Grigio Grey Grau Gris | Cromo Lucido Polished Chromed Poliert Verchromt Chrome Brillant | | | |

| | | | | |
|-------------------------------------------------------------------------------------|-------------------------------------------------------------------------------------|-------------------------------------------------------------------------------------|-----------------------|-----------------------------|
| Roma | by Jonas Wagell | | Sofa, Armchair | Non-removable covers |
|  |  |  | | |
| OROM234 W 234,5 D 121,4/84 cm H 73,5 Seat H 38,5 cm | OROM230 W 233 D 92 H 73,5 cm H seat 38,5 cm | OROM106 W 106,3 D 88,5 H 73,5 cm Seat H 38,5 cm | | |

| | | | | |
|-------------------------------------------------------------------------------|-------------------------------------------------------------------------------------|-------------------------------------------------------------------------------------|-------------------------------------------------------------------------------------|----------------------------------------------------------------------------------------------|
| |  |  |  |  |
| | T02 | T07 | T24 | T25 |
| Base verniciata Painted base Gestell lackiert Piétement laqué | Bianco White Weiss Blanc | Nero Black Schwarz Noir | Base cromata Chromed base Gestell verchromt Piétement chromé | Cromo Satinato Satin Chrome Satinert Verchromt Chrome Satiné |
| | RAL 9016 | RAL 9011 | | Oro Champagne Opaco Matt Champagne Gold Matt Champagne Gold Or Champagne Mat |

| | | | | |
|-------------------------------------------------------------------------------------|-------------------------------------------------------------------------------------|-------------------------------------------------------------------------------------|--------------------------------|-----------------------------|
| Santiago | by Claesson Koivisto Rune | | Sofa, Armchair, Ottoman | Non-removable covers |
|  |  |  | | |
| OSANT164 W 164 D 88 H 85 cm Seat H 41 cm | OSANT96 W 96 D 88 H 85 cm Seat H 41 cm | OSANT93 W 93 D 71 H 40 cm Seat H 40 cm | | |

| | | | | |
|-----------------------------------------|---------------------------------------------------------------------------------------|---------------------------------------------------------------------------------------|---------------------------------------------------------------------------------------|---------------------------------------------------------------------------------------|
| |  |  |  |  |
| | T02 | T03 | T07 | T44 |
| Piedini Feet FüÙe Pieds | Bianco White Weiss Blanc | Grigio Grey Grau Gris | Nero Black Schwarz Noir | Tinto Noce Chiaro Light Walnut Licht Walnuss Noyer Clair |
| | RAL 9016 | RAL 7016 | RAL 9011 | |











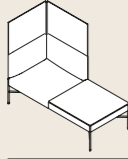

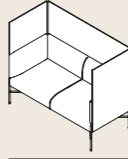
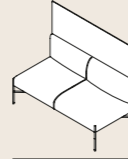
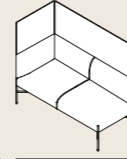
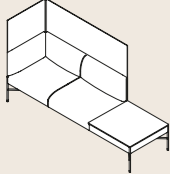
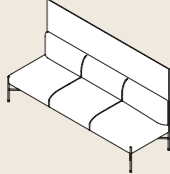
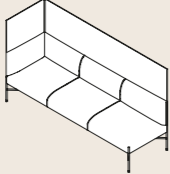
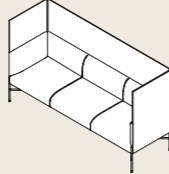
| | | | | | |
|---------------------------------------------------------------------------------------|---------------------------------------------------------------------------------------|--|-----------------------|-----------------------|-----------------------------|
| Sella | by Carlo De Carli | | Sofa, Armchair | Design Classic | Non-removable covers |
|  |  | | | | |
| OSEL222 W 222 D 97 H 83 cm H seat 42 cm | OSEL102 W 102 D 97 H 83 cm H seat 42 cm | | | | |







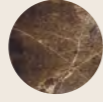



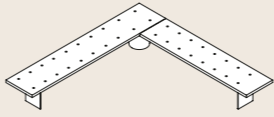
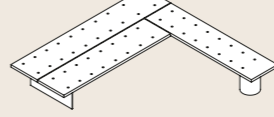
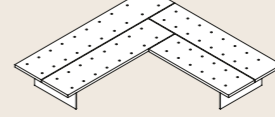
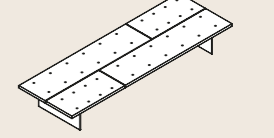
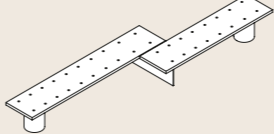
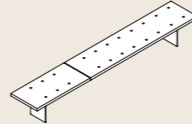
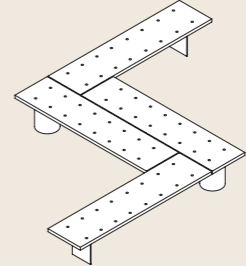

| Sesann | by Gianfranco Frattini | | Sofa, Armchair | Design Classic | Non-removable covers |
|--------------------------------------------------------------------------|------------------------------------------------------------------------|---------------------------------------------------------------------------------------|-------------------------------------------------------------------------------------|-----------------------------------------------------------------------------------------|------------------------------------------------------------------------------------------|
| | | | | | |
| OSSES240 W 240 D 94 H 67 cm Seat H 38 cm | OSSES180 W 180 D 94 H 67 cm Seat H 38 cm | OSSES110 W 110 D 94 H 67 cm Seat H 38 cm | | | |
| | | | | | |
| | T02 RAL 9016 | T07 RAL 9011 | T11 RAL 2011 | T61 RAL 6014 | |
| Struttura Structure Gestell Piétement | Bianco White Weiss Blanc | Nero Black Schwarz Noir | Arancio Orange Orange Orange | Verde Scuro Dark Green Dunkelgrün Vert Foncé | |
| | | | | | |
| T23 | T24 | T25 | T27 | T28 | T64 |
| Cromo Lucido Polished Chromed Poliert Verchromt Chrome Brillant | Cromo Satinato Satin Chrome Satiniert Verchromt Chrome Satiné | Oro Champagne Opaco Matt Champagne Gold Matt Champagne Gold Or Champagne Mat | Cromo Nero Opaco Matt Black Chromed Matt Schwarz Verchromt Chrome Noir Mat | Cromo Nero Lucido Polished Black Chromed Schwarz-Glänzend Chrome Noir Brillant | Rame Spazzolato Opaco Brush Matt Copper Matt Gebürstet Kupfer Brossé Mat Cuivre |
| | | | | | |
| | T43 | T49 | | | |
| Piedini Feet Füßen Patins | Noce Scuro Dark Walnut Dunkel Walnuss Noyer Foncé | Tinto Grigio Grey Grau Gris | | | |



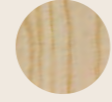

| Sliding | by Pietro Arosio | | Sofa, Sofa Bed | Removable covers |
|-------------------------------------------------|--------------------------------------------------|----------------------------------------------------------|--------------------------------------|--------------------------------------------------------|
| | | | | |
| OINGV200 W 204 D 100 H 83 cm Seat H 42 cm | W 204 D 144 H 42 cm Seat H 42 cm | Brevettato Patented | | |
| | | | | |
| | T07 RAL 9011 | T03 RAL 7016 | T03 RAL 7016 | |
| Base Base Gestell Piétement | Alluminio Aluminium Aluminium Aluminium | Piedino Nero Black Feet Füße Schwarz Pieds Noir | Base Base Gestell Piétement | Grigio Grey Grau Gris |
| | | | | Piedino Grigio Grey Feet Füße Grau Pieds Gris |

| Chill-Out | by Gordon Guillaumier | | Modular System | Non-removable covers | |
|-------------------------------------------------|-------------------------------------------------|-------------------------------------------------|-------------------------------------------------|-------------------------------------------------|-------------------------------------------------|
| | | | | | |
| OCHILP70 W 74 D 69 H 71 cm Seat H 44 cm | OCHILQ70 W 74 D 69 H 71 cm Seat H 44 cm | OCHILR70 W 74 D 69 H 71 cm Seat H 44 cm | OCHILI70 W 74 D 69 H 44 cm Seat H 44 cm | OCHILL141 W 144 D 69 H 71 cm Seat H 44 cm | OCHILM141 W 144 D 69 H 71 cm Seat H 44 cm |
| | | | | | |
| OCHILN141 W 144 D 69 H 71 cm Seat H 44 cm | OCHILH141 W 144 D 69 H 44 cm Seat H 44 cm | OCHILO141 W 144 D 69 H 71 cm Seat H 44 cm | OCHILG141 W 144 D 69 H 44 cm Seat H 44 cm | OCHILD212 W 214 D 69 H 71 cm Seat H 44 cm | OCHILS212 W 214 D 69 H 71 cm Seat H 44 cm |
| | | | | | |
| OCHILE212 W 214 D 69 H 71 cm Seat H 44 cm | OCHILA212 W 214 D 69 H 44 cm Seat H 44 cm | OCHILF212 W 214 D 69 H 71 cm Seat H 44 cm | OCHILB212 W 214 D 69 H 44 cm Seat H 44 cm | OCHILC212 W 214 D 69 H 44 cm Seat H 44 cm | |
| | | | | | |
| 1CHIL70 W 72 D 67 H 38,5 cm | 1CHIL140 W 142 D 67 H 38,5 cm | | | | |

| Chill-Out High Back/Arms | by Gordon Guillaumier | | Modular System | Non-removable covers | |
|--------------------------------------------------|--------------------------------------------------|-------------------------------------------------|-------------------------------------------------|-------------------------------------------------|--------------------------------------------------|
| | | | | | |
| OCHILP70H W 74 D 69 H 71 cm Seat H 44 cm | OCHILQ70H L74 D 69 H 71 cm Seat H 44 cm | OCHILL141H L144 D 69 H 71 cm Seat H 44 cm | OCHILM141H L144 D 69 H 71 cm Seat H 44 cm | OCHILO141H L144 D 69 H 71 cm Seat H 44 cm | OCHILD212H W 214 D 69 H 71 cm Seat H 44 cm |
| | | | | | |
| OCHILS212H W 214 D 69 H 71 cm Seat H 44 cm | OCHILF212H W 214 D 69 H 71 cm Seat H 44 cm | | | | |

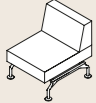
| Chill-Out High | by Gordon Guillaumier | | Modular System | | Non-removable covers |
|----------------------------------------------------------------------------------|-------------------------------------------------------------------------------------|---------------------------------------------------------------------------------------|---------------------------------------------------------------------------------------------------|---------------------------------------------------------------------------------------------------------------------------------------------------------------------------------------------------------------------------------------------------------------------------------------------------------------------------------------------------------------|------------------------------------------------------------------------------------------|
|  |  |  |  |  |  |
| OCHILHQ70 L74 D 69 H 121 cm Seat H 44 cm | OCHILHO141 L144 D 69 H 121 cm Seat H 44 cm | OCHILT141 L144 D 69 H 121 cm Desk H 70 cm | OCHILHL141 L144 D 69 H 121 cm Seat H 44 cm | OCHILHN141 W 144 D 69 H 121 cm Seat H 44 cm | OCHILHM141 L144 D 69 H 121 cm Seat H 44 cm |
|  |  |  |  | <p>OCHILHS212 OCHILHM141 OCHILHQ70</p> <p>Bracciolo destro o sinistro guardando il prodotto frontalmente. Right or left armrest when in front of the item.</p> <p>OCHILHF212 OCHILHO141</p> <p>Tavolino destro o sinistro guardando il prodotto frontalmente. Right or left tablet when in front of the item.</p> | |
| OCHILHF212 W 214 D 69 H 121 cm Seat H 44 cm | OCHILHE212 W 214 D 69 H 121 cm Seat H 44 cm | OCHILHS212 W 214 D 69 H 121 cm Seat H 44 cm | OCHILHD212 W 214 D 69 H 121 cm Seat H 44 cm | | |
| |  |  |  |  |  |
| | T02 | T03 | T24 | T25 | T64 |
| Base Base Gestell Piétement | Bianco White Weiss Blanc | Grigio Grey Grau Gris | Cromo Satinato Satin Chromed Satinier Verchromt Chrome Satiné | Oro Champagne Opaco Matt Champagne Gold Matt Champagne Gold Or Champagne Mat | Rame Spazzolato Opaco Brush Matt Copper Matt Gebürstet Kupfer Brossé Mat Cuivre |
| |  |  |  |  | |
| | T30 | T31 | T33 | T35 | |
| Piano Top Tischplatte Plateau | Carrara Opaco Matt White Carrara Matt Carrara Carrara Mat | Calacatta Lucido Shiny White Calacatta Calacatta Glänzend Calacatta Brillant | Black Travertino Opaco Matt Black Travertine Matt Schwarz Travertino Noir Travertino Mat | Basaltina Opaco Matt Basaltina Matt Basaltina Basaltina Mat | |

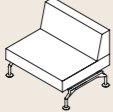
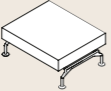
| Galleria | by PearsonLloyd | | Modular System | | Non-removable covers |
|-------------------------------------------------------------------------------------|---------------------------------------------------------------------------------------|---------------------------------------------------------------------------------------|---------------------------------------------------------------------------------------|---------------------------------------------------------------------------------------|-------------------------------------------------------------------------------------|
|  |  |  |  | | |
| OGALA250 W 250 D 250 H 42 cm Seat H 42 cm | OGALB250 W 250 D 250 H 42 cm Seat H 42 cm | OGALC250 W 250 D 250 H 42 cm Seat H 42 cm | OGALD300 W 300 D 98 H 42 cm Seat H 42 cm | | |
|  |  |  | | | |
| OGALSH400 W 400 D 98 H 42 cm Seat H 42 cm | OGALSI300 W 300 D 49 H 42 cm Seat H 42 cm | OGALSS400 W 400 D 250 H 42 cm Seat H 42 cm | | | |
|  |  |  |  |  |  |
| 1GALTM Ø 40 H 10 cm | 1GALTL Ø 40 H 52 cm | OGALC49 49 x 49 cm | OGALC99 49 x 99 cm | OGALP W 100 D 18 H 34 cm | 1GALT Ø 40,5 cm H 9,5 cm |
| |  |  |  |  | |
| | T45 | T49 | T02 | T03 | |
| Piano legno Wooden top Holzplatte Plateau en bois | Naturale Natural Naturel | Tinto Grigio Grey Grau Gris | Base verniciata Painted base Gestell lackiert Piétement laqué | Bianco White Weiss Blanc | Grigio Grey Grau Gris |
| |  |  |  | | |
| | T02 | T03 | T30 | | |
| Tavolino metallo Little metal table Metalltisch Table en métal | Bianco White Weiss Blanc | Grigio Grey Grau Gris | Tavolino marmo Little marble table Marmortisch Table de marbre | Carrara Opaco Matt White Carrara Matt Carrara Carrara Mat | |

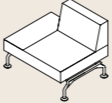
| | | | | | |
|----------------------------------------------------------------------------------|-----------------------------------------------------------------------------------|-----------------------------------------------------------------------------------|-----------------------------------------------------------------------------------|-------------------------------------------------------------------------------------|-------------------------------------------------------------------------------------|
|  |  |  |  |  |  |
| OINA60 W 60 D 75 H 73 cm Seat H 40 cm | OINAP60 W 60 D 75 H 40 cm Seat H 40 cm | OINB90 W 90 D 75 H 73 cm Seat H 40 cm | OINBP90 W 90 D 75 H 40 cm Seat H 40 cm | OINB390 W 90 D 75 H 73 cm Seat H 40 cm | OINB490 W 90 D 75 H 73 cm Seat H 40 cm |

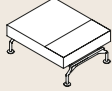
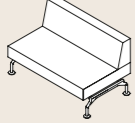
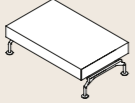
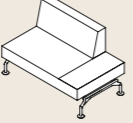
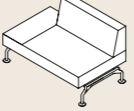
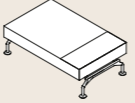

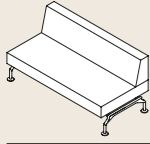
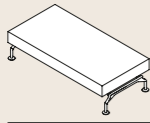
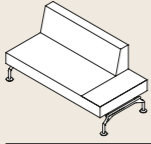
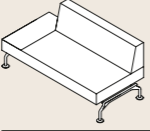
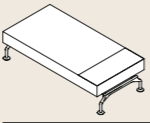
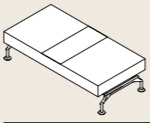
| | | | | | |
|----------------------------------------------------------------------------------|-----------------------------------------------------------------------------------|-----------------------------------------------------------------------------------|-----------------------------------------------------------------------------------|-------------------------------------------------------------------------------------|-------------------------------------------------------------------------------------|
|  |  |  |  |  |  |
| OINB190 W 90 D 75 H 40 cm Seat H 40 cm | OINC120 W 120 D 75 H 73 cm Seat H 40 cm | OINCP120 W 120 D 75 H 40 cm Seat H 40 cm | OINC3120 W 120 D 75 H 73 cm Seat H 40 cm | OINC4120 W 120 D 75 H 73 cm Seat H 40 cm | OINC1120 W 120 D 75 H 40 cm Seat H 40 cm |

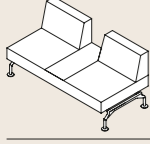
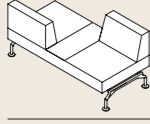
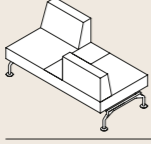
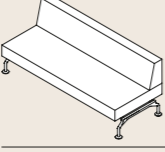
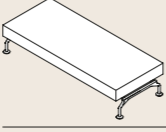
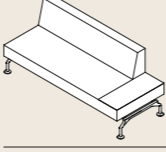
| | | | | | |
|----------------------------------------------------------------------------------|-----------------------------------------------------------------------------------|-----------------------------------------------------------------------------------|-----------------------------------------------------------------------------------|-------------------------------------------------------------------------------------|-------------------------------------------------------------------------------------|
|  |  |  |  |  |  |
| OIND150 W 150 D 75 H 73 cm Seat H 40 cm | OINDP150 W 150 D 75 H 40 cm Seat H 40 cm | OIND3150 W 150 D 75 H 73 cm Seat H 40 cm | OIND4150 W 150 D 75 H 73 cm Seat H 40 cm | OIND1150 W 150 D 75 H 40 cm Seat H 40 cm | OIND2150 W 150 D 75 H 40 cm Seat H 40 cm |

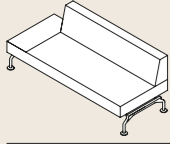
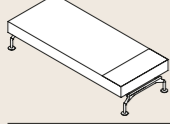
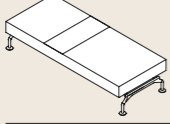
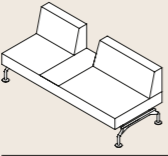
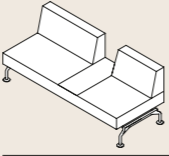
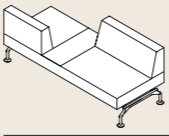

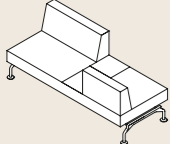
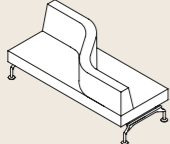
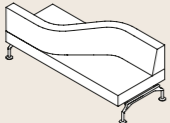
| | | | | | |
|------------------------------------------------------------------------------------|-------------------------------------------------------------------------------------|-------------------------------------------------------------------------------------|-------------------------------------------------------------------------------------|---------------------------------------------------------------------------------------|---------------------------------------------------------------------------------------|
|  |  |  |  |  |  |
| OIND5150 W 150 D 75 H 73 cm Seat H 40 cm | OIND6150 W 150 D 75 H 73 cm Seat H 40 cm | OIND7150 W 150 D 75 H 73 cm Seat H 40 cm | OINO180 W 180 D 75 H 73 cm Seat H 40 cm | OINOP180 W 180 D 75 H 40 cm Seat H 40 cm | OINO3180 W 180 D 75 H 73 cm Seat H 40 cm |

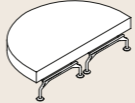
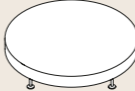
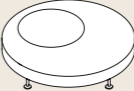
| | | | | | |
|------------------------------------------------------------------------------------|-------------------------------------------------------------------------------------|-------------------------------------------------------------------------------------|-------------------------------------------------------------------------------------|---------------------------------------------------------------------------------------|---------------------------------------------------------------------------------------|
|  |  |  |  |  |  |
| OINO4180 W 180 D 75 H 73 cm Seat H 40 cm | OINO1180 W 180 D 75 H 40 cm Seat H 40 cm | OINO2180 W 180 D 75 H 40 cm Seat H 40 cm | OINO5180DX W 180 D 75 H 73 cm Seat H 40 cm | OINO5180SX W 180 D 75 H 73 cm Seat H 40 cm | OINO6180 W 180 D 75 H 73 cm Seat H 40 cm |





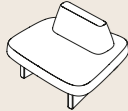
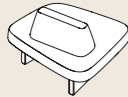

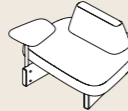
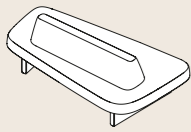
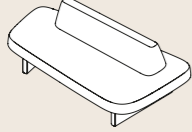
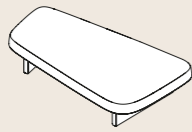
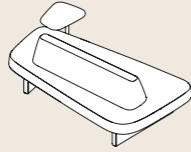
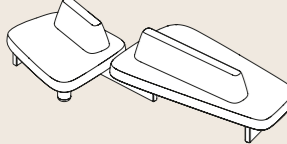
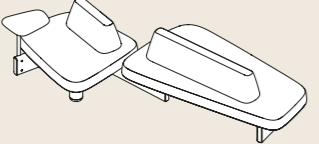
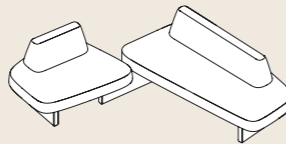
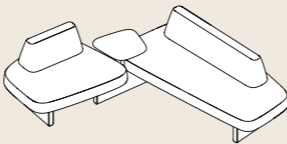
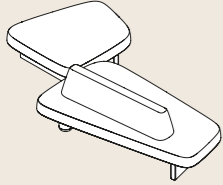
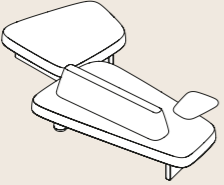
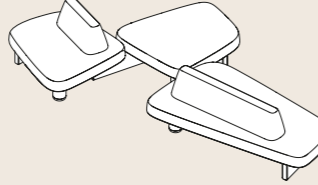
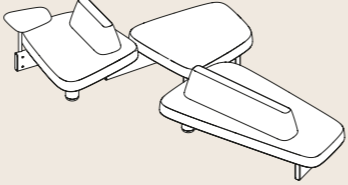



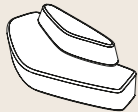

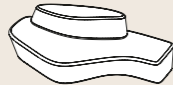

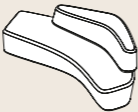
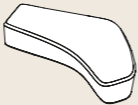

| | | | | | |
|------------------------------------------------------------------------------------|-------------------------------------------------------------------------------------|-------------------------------------------------------------------------------------|--|--|--|
|  |  |  | | | |
| OINO7180 W 180 D 75 H 73 cm Seat H 40 cm | OINR180 W 180 D 75 H 73 cm Seat H 40 cm | OINS180 W 180 D 75 H 73 cm Seat H 40 cm | | | |

| | | | | |
|-------------------------------------------------------------------------------------|-------------------------------------------------------------------------------------|-------------------------------------------------------------------------------------|-------------------------------------------------------------------------------------|-------------------------------------------------------------------------------------|
|  |  |  |  |  |
| OINU151 W 151 D 89,5 H 73 cm Seat H 40 cm | OINUP151 W 151 D 89,5 H 40 cm Seat H 40 cm | OINP150 Ø 150 H 40 cm Seat H 40 cm | OINPT150 Ø 150 H 40 cm Seat H 40 cm | OINBR W 55 D 22 H 10,5 cm |

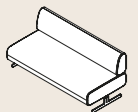
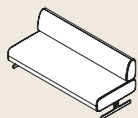
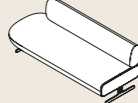
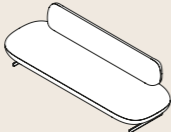
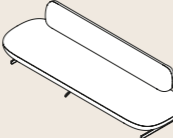
| | | | | | |
|----------------------------------------|-------------------------------------------------------------------------------------|-------------------------------------------------------------------------------------|--|--|--|
| |  |  | | | |
| Piano Top Tischplatte Plateau | T30 Carrara Opaco Matt White Carrara Matt Carrara Carrara Mat | T35 Basaltina Opaco Matt Basaltina Matt Basaltina Basaltina Mat | | | |

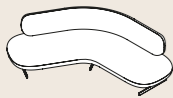
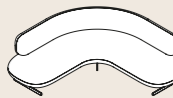
| Ischia | by PearsonLloyd | Modular System | Non-removable covers |
|-----------------------------------------------------------------------------------|------------------------------------------------------------------------------------|-------------------------------------------------------------------------------------|--------------------------------------------------------------------------------------|
|  |  |  |  |
| OISCH1C W 119,3 D 103,8 H 75,5 cm Seat H 43 cm | OISCH1L W 119,3 D 103,8 H 75,5 cm Seat H 43 cm | OISCH1P W 119,3 D 103,8 H 75,5 cm Seat H 43 cm | OISCH1CT W 119,3 D 117,8 H 75,5 cm Seat H 43 cm |
|  |  |  |  |
| OISCH2C W 199,2 D 103,8 H 75,5 cm Seat H 43 cm | OISCH2L W 199,2 D 103,8 H 75,5 cm Seat H 43 cm | OISCH2P W 199,2 D 103,8 H 75,5 cm Seat H 43 cm | OISCH2CT W 199,2 D 112,4 H 75,5 cm Seat H 43 cm |
|  |  |  |  |
| OISCHTA W 316,1 D 173,5 H 75,5 cm Seat H 43 cm | OISCHTAT W 316,1 D 173,5 H 75,5 cm Seat H 43 cm | OISCHTB W 262,2 D 233,3 H 75,5 cm Seat H 43 cm | OISCHTBT W 262,2 D 233,3 H 75,5 cm Seat H 43 cm |
|  |  |  |  |
| OISCHTC W 306,5 D 180,5 H 75,5 cm Seat H 43 cm | OISCHTCT W 306,5 D 180,5 H 75,5 cm Seat H 43 cm | OISCHTE W 397,1 D 222,1 H 75,5 cm Seat H 43 cm | OISCHTET W 397,1 D 222,1 H 75,5 cm Seat H 43 cm |

| Ischia | by PearsonLloyd | Modular System | Non-removable covers |
|---------------------------------------------------------------------------------------|---------------------------------------------------------------------------------------|-------------------------------------------------------------------------------------------------------|---------------------------------------------------------------------------------------|
| |  |  |  |
| | T30 | T32 | T45 |
| Piedini Feet Füße Pieds | Carrara Opaco Matt White Carrara Matt Carrara Carrara Mat | Marquinia Lucido Shiny Black Marquinia Schwarz Marquinia Glänzend Noir Marquinia Brillant | Base Base Gestell Piétement |
| |  |  |  |
| | T02 | T03 | T30 |
| Base tavolino Top base Tisch Basement table | Bianco White Weiss Blanc | Grigio Grey Grau Gris | Carrara Opaco Matt White Carrara Matt Carrara Carrara Mat |
| |  |  |  |
| | T83 | T84 | T32 |
| Cucitura punto cavallo: colore filati Blanket stitch seam: yarn color |  |  |  |
| | T85 | T86 | T87 |
| |  | | |
| | T88 | | |
| Ischia | by PearsonLloyd | Screen | |
|  | | | |
| OISCP W 135,5 D 45 H 136,9 cm | | | |
| |  |  |  |
| | T45 | T49 | |
| Cornice Frame Rahmen Cadre | Naturale Natural Natural Naturel | Tinto Grigio Grey Grau Gris | Finitura Finish Finish Finition |
| | | | Paglia di Vienna Cane Webbing Wiener Geflecht Cannage Paille de Vienne |

| Polar | by PearsonLloyd | | Modular System, Armchair, Ottoman | | Non-removable covers |
|------------------------------------------------------------------------------------|-------------------------------------------------------------------------------------|-------------------------------------------------------------------------------------|-------------------------------------------------------------------------------------|---------------------------------------------------------------------------------------|---------------------------------------------------------------------------------------|
|  |  |  |  |  |  |
| OPOLA234 W 234 D 107 H 73 cm Seat H 37 cm | OPOLAP234 W 234 D 107 H 37 cm Seat H 37 cm | OPOLB234 W 234 D 107 H 73 cm Seat H 37 cm | OPOLBP234 W 234 D 107 H 37 cm Seat H 37 cm | OPOLC234 W 234 D 107 H 73 cm Seat H 37 cm | OPOLCP234 W 234 D 107 H 37 cm Seat H 37 cm |
|  |  |  |  | | |
| OPOLD234 W 234 D 107 H 73 cm Seat H 37 cm | OPOLDP234 W 234 D 107 H 37 cm Seat H 37 cm | OPOL107 W 107 D 81,5 H 67 cm Seat H 37 cm | OPOLP107 W 107 D 81,5 H 37 cm Seat H 37 cm | | |
| Polar Perch | by PearsonLloyd | | Modular System | | Non-removable covers |
|  |  | | | | |
| OPER220 W 220 D 79 H 70 cm Seat H 70 cm | OPER207 W 207 D 84,5 H 46 cm Seat H 46 cm | | | | |
| Stone Low/High | by PearsonLloyd | | Modular System | | Non-removable covers |
|  |  |  |  |  |  |
| OSTAB150/OSTAA150 W 150 D 73 H 68/77 cm Seat H 39/45 cm | OSTBB170/OSTBA170 W 170 D 73 H 68/77 cm Seat H 39/45 cm | OSTCB190/OSTCA190 W 190 D 73 H 68/77 cm Seat H 39/45 cm | OSTDB200/OSTDA200 W 200 D 73 H 68/77 cm Seat H 39/45 cm | OSTEB230/OSTEA230 W 230 D 73 H 68/77 cm Seat H 39/45 cm | OSTFB90/OSTFA90 W 144 D 100 H 68/77 cm Seat H 39/45 cm |
|  |  | | | | |
| OSTGB120/OSTGA120 W 238 D 112 H 68/77 cm Seat H 39/45 cm | OSTHB90/OSTHA90 W 250 D 134 H 68/77 cm Seat H 39/45 cm | | | | |
| |  |  | |  | |
| | T02 Bianco White Weiss Blanc | T07 Nero Black Schwarz Noir | | T24 Cromo Satinato Satin Chromed Satiniert Verchromt Chrome Satiné | |
| Base verniciata Painted base Gestell lackiert Piétement laqué | | | Base cromata Chromed base Gestell verchromt Piétement chromé | | |

Qualità

La collezione e i progetti Tacchini non si fermano alla produzione e ai suoi processi. La storia di questa famiglia, e dell'azienda che ne porta il nome, si intreccia con la storia del design italiano e internazionale: ogni capitolo è stato scritto con cura e attenzione per il dettaglio, e ogni oggetto traduce queste passioni. E ancora, Tacchini vuole rivelare, dalle segrete stanze del suo fare, i modi e i metodi con cui si trattano i materiali, l'attenzione con cui si curano le superfici e se ne preservano la qualità estetiche, i segreti e le virtù delle tecnologie impiegate per trattarli, dall'esperienza del passato all'innovazione della ricerca.

Tacchini per l'Ambiente

Da anni, Tacchini ha implementato la sua attenzione per l'ambiente, in linea con la normativa UNI EN ISO 14001:2004. Ogni fase del processo produttivo è oggetto di controlli rigorosi: dal progetto alla realizzazione, coinvolgendo ogni dipartimento, ogni collaboratore e ogni fornitore. Fino al cliente. Ognuno dei pezzi Tacchini è realizzato secondo gli standard internazionali più severi, in ambienti di lavoro di assoluto comfort, con l'impiego di materiali italiani, di provenienza certificata. Tutte le lavorazioni sono studiate nell'assoluto rispetto dell'ambiente: riducendo al minimo lo spreco di materiale e i livelli di emissioni. Tutto questo, permette che ogni prodotto Tacchini sia parzialmente riciclabile.

Tacchini per la Qualità

L'attenzione per la qualità comincia dalla scelta dei materiali, già capaci di trasmettere forti emozioni, e esaltati dalla cura del dettaglio e dall'innovazione tecnologica: percepibile poi in ogni pezzo o spazio progettati da Tacchini. La qualità del prodotto, risultato sinergico tra tradizione, progresso e immaginazione progettuale, diventa poi qualità del servizio: sia nei processi commerciali che di post vendita.

Tacchini per l'Italia

La creatività senza limiti o confini, la tradizione nel mondo dell'arredamento, patrimonio dei padri fondatori, capaci di trasmettere valori unici alle generazioni successive, il progresso tecnologico sempre aggiornato, rendono unico ogni prodotto: e tutti i pezzi della collezione Tacchini sono realizzati in Italia. Esempio autentico di Made in Italy.

The Tacchini collection and designs are about more than just production and processes. The history of this family, and of the company that bears its name, is interwoven with the history of Italian and international design: each chapter was written with care and attention to detail, and each product reflects this passion. From the secret rooms where its work is done, Tacchini wants to reveal the means and methods used to prepare the materials, the care with which it treats its surfaces, safeguarding their fine appearance, the secrets and virtues of the technologies used to treat them, from the experience of the past to modern research and innovation.

Tacchini for the Environment

For years, Tacchini has paid careful attention to the environment, adhering to standard UNI EN ISO 14001:2004. Each phase of the production process is subject to strict controls, from design to manufacture, involving every department, every staff member and every supplier. Right through to the customer. Each Tacchini piece is produced according to exacting international standards, in working environments offering excellent standards of comfort, and using Italian materials from certified sources. All processes are developed to ensure absolute respect for the environment, reducing waste material and emission levels to the minimum. These measures mean that every Tacchini product can be partially recycled.

Tacchini for Quality

Attention to quality begins with the choice of materials, which in themselves can convey strong sensations, and are further enhanced by the regard for detail and by technological innovations, which are noticeable in every piece and every space designed by Tacchini. Product quality is the fruit of a synergy between tradition, progress and imaginative design, and is then reflected in service quality, both during the sales process and post-sales.

Tacchini for Italy

Our creativity knows no bounds. The furniture-making tradition handed down from our founding fathers who knowingly conveyed unique values to the new generations, our constant position on the leading edge of technological progress: these factors make each product unique, and all pieces in the Tacchini collection are made in Italy. A genuine example of Italian-made quality.

Tacchini si impegna concretamente per il rispetto dell'ambiente, lo sviluppo sostenibile ed il consumo intelligente. La qualità dei materiali e della realizzazione garantisce una lunga vita dei prodotti, riducendo il consumo di energia, le emissioni in atmosfera e l'impatto ambientale al termine del loro utilizzo. W'azienda utilizza legni provenienti da coltivazioni a ricrescita controllata, privilegia l'impiego di materiali riciclabili e riduce al massimo gli sprechi in fase di produzione e imballo.

Tacchini is concretely committed to environment respect, sustainable development and clever consumption. Materials and manufacturing quality guarantees long lasting products, reducing energy consumption, emissions into the atmosphere and environmental impact when their use is over. The company uses wood from sustainable cultivations, favours recyclable materials and highly reduces waste during both production and packing steps.

Tacchini T'20
Objects, Stories

Graphic design:
Think Work Observe

Photography:
Andrea Ferrari

Styling:
Maria Gabriella Zecca

Copy editing:
Gaia De Santis
Massimiliano
Di Bartolomeo

Post production:
Erica Fadini

Color separation
and printing:
Nava

Copyright © 2020 Tacchini
Italia Forniture Srl
All rights reserved. No part
of this publication may be
reproduced or transmitted in
any form or by any means,
electronic or mechanical,
without prior permission of
the owner. All copyrights and
intellectual property rights,
including trademarks, patents
and copyrights, remain the
property of Tacchini Italia
Forniture Srl and are explicitly
reserved.

Acknowledgments:
Artemide
Astep
Bitossi Home
cc tapis
Flos
Fontana Arte
Ghidini 1961
Incipit Lab
Martinelli Luce
Nemo Lighting
Nodus
Orsjo
Penta Light
Stelton
Wastberg
Zero Lighting

Tacchini Italia Forniture Srl

19, via Domodossola
20822 Baruccana di Seveso
(Monza Brianza) Italy
T: +39 0362 50 41 82
E-mail: info@tacchini.it
www.tacchini.it

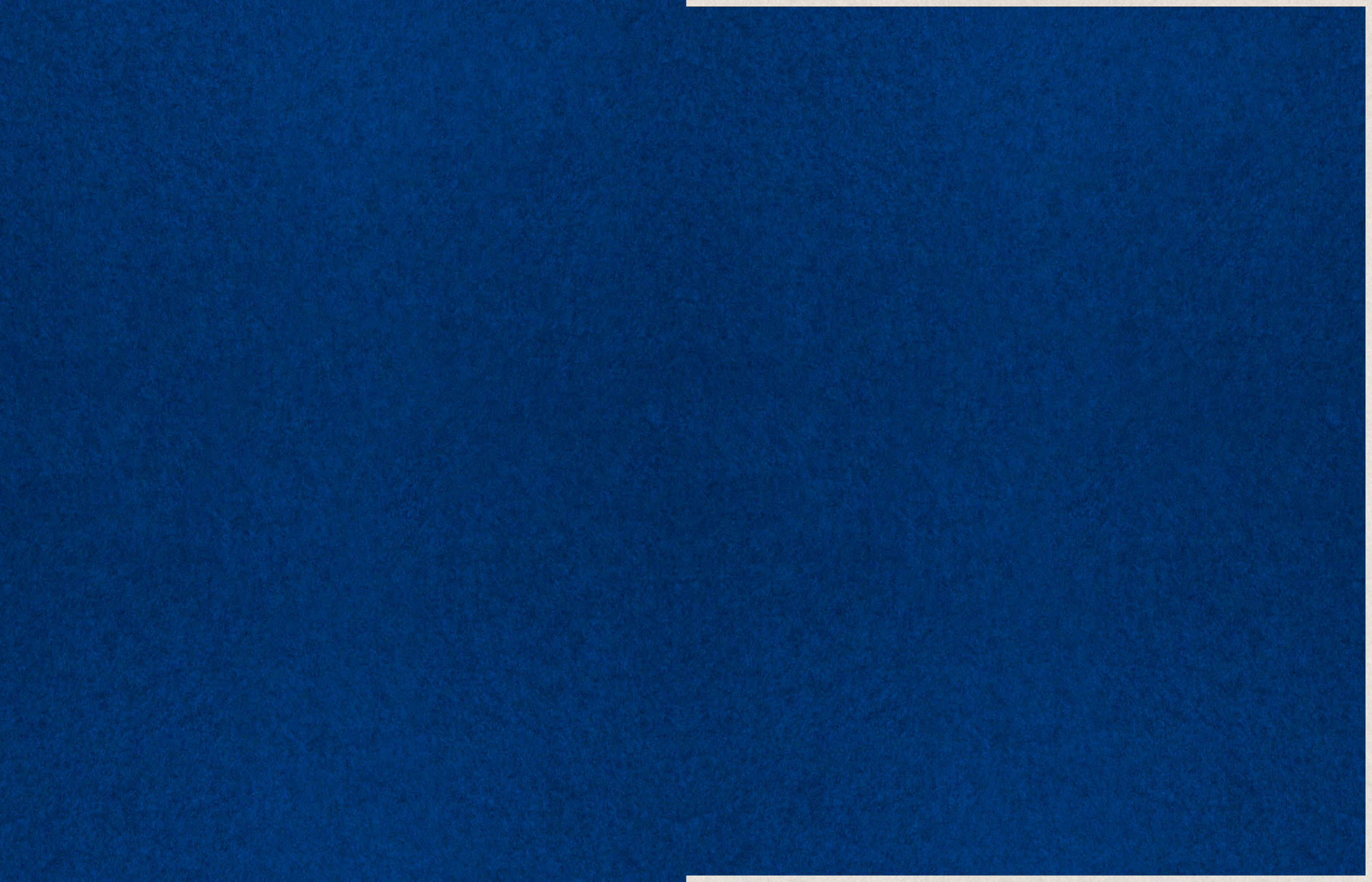

T'20 Objects, Stories
cat. Armchairs, Ottomans,
Chaises-longues, Chairs,
Stools, Tables, Low Tables

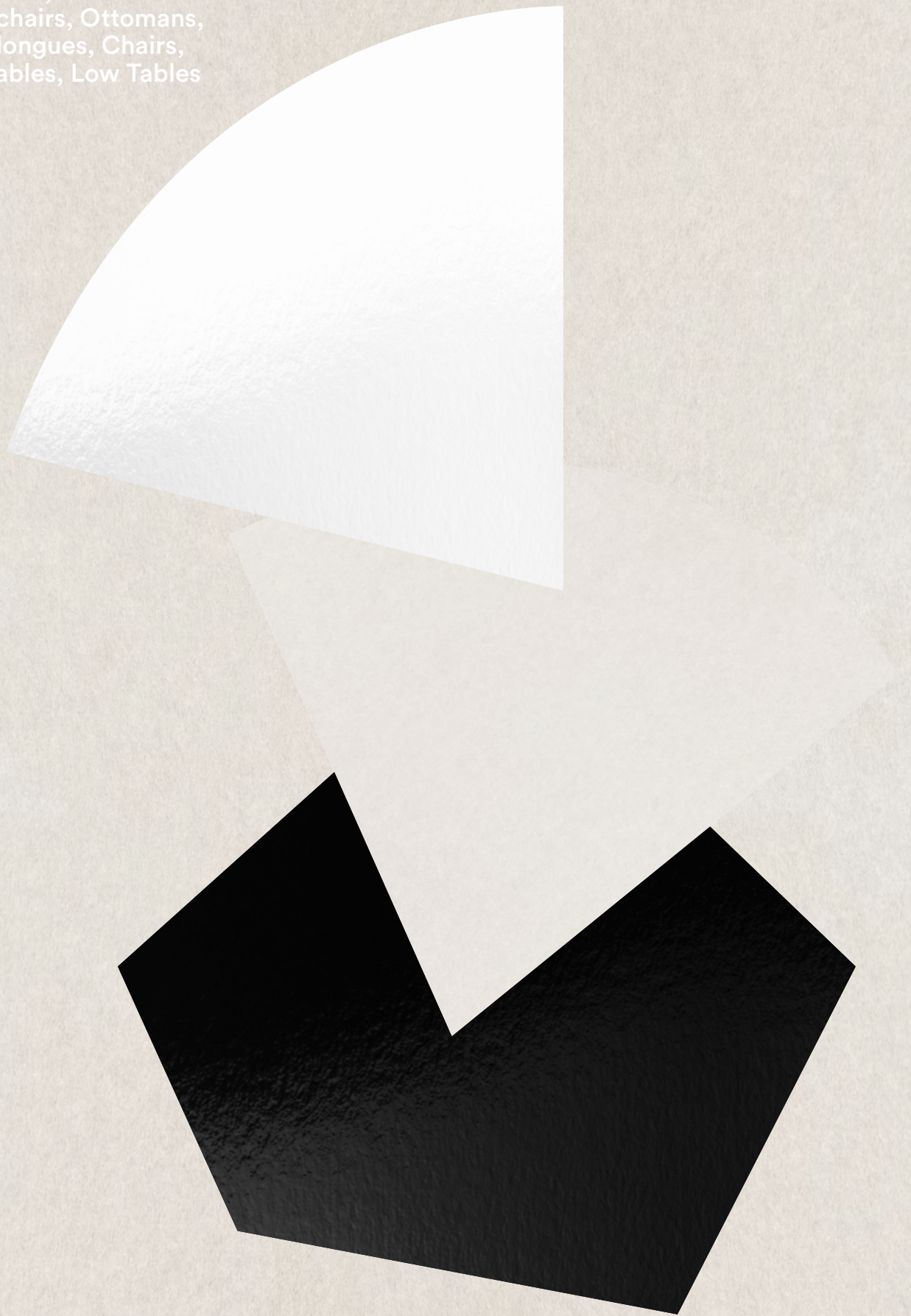

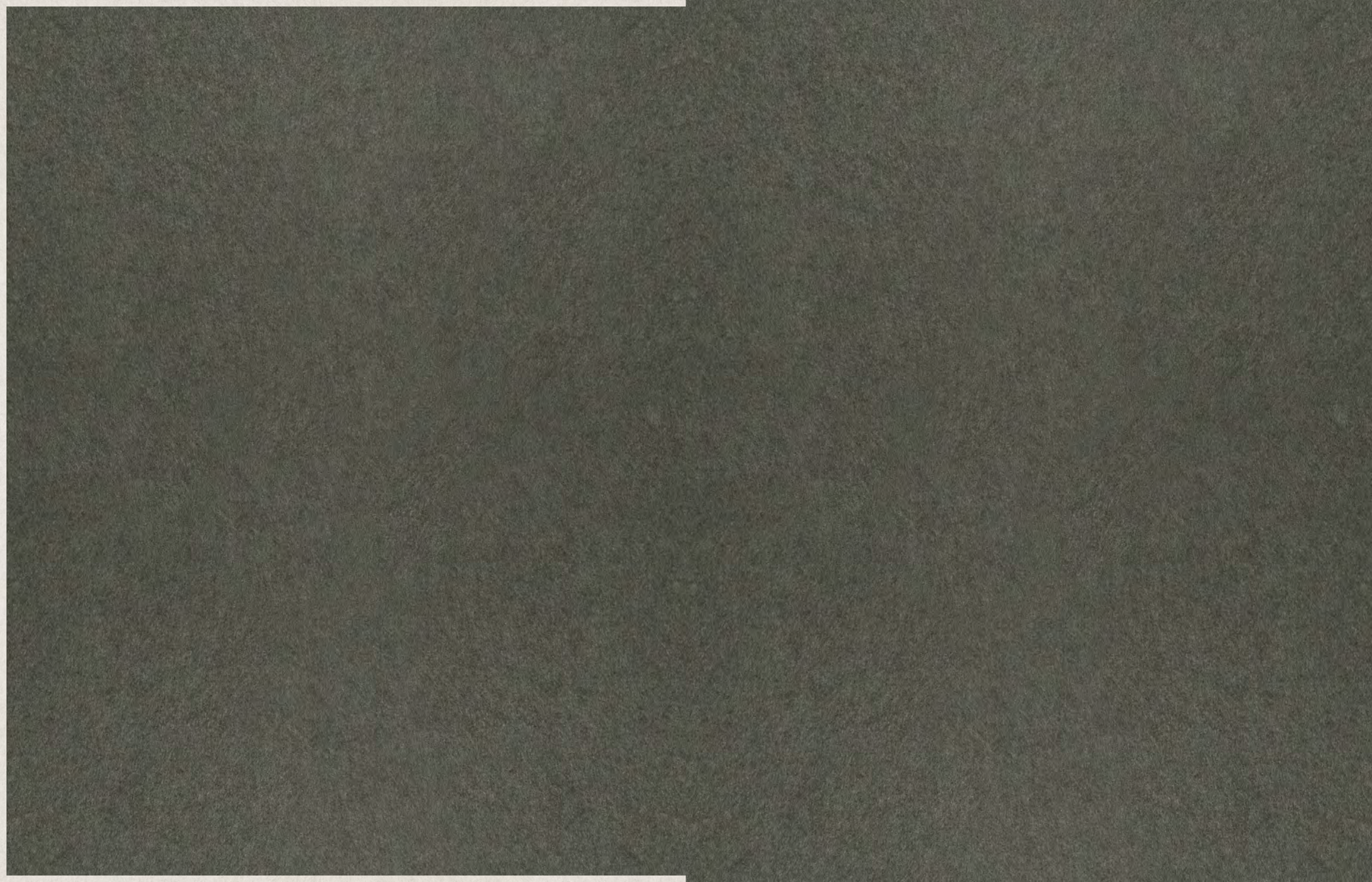

Object, Stories

T'20 Vol. B

Design



Classics

I maestri sono quelle figure carismatiche, capaci di insegnare e trasmettere un'arte: attraverso il proprio agire diretto, ma anche nel lascito delle loro opere stesse. Nel design, i maestri parlano attraverso i classici: progetti senza tempo e fuori da qualsiasi logica di mode e tendenze, ma talmente potenti da determinare naturalmente uno stile. Tacchini ha riservato alcune stanze del suo abitare ai classici e ai maestri che li hanno disegnati, in un percorso di riedizioni che sfida e insegna alla contemporaneità.

“Cancellare, cancellare, cancellare e alla fine trovare un componente principale di progettazione; noi mentre progettavamo eravamo contro l'invasione del disegno, eravamo alla ricerca del tratto minimo che serviva alla funzione; volevamo arrivare a dire: meno di così non si può fare.” Achille Castiglioni



Ci sono progetti che nascono classici già nei nomi che portano. Babela è uno di quei progetti e di quei nomi. Nel 1958 Achille Castiglioni disegna questa poltroncina per completare l'arredamento della Camera di commercio di Milano: il comfort si incontra con la forma e la funzionalità, svelata nella possibilità di poter impilare questa seduta, come una torre.



“Un oggetto di design è il frutto dello sforzo comune di molte persone dalle diverse specifiche competenze tecniche, industriali, commerciali, estetiche. Il lavoro del designer è la sintesi espressiva di questo lavoro collettivo. Quello che caratterizza la progettazione è proprio il rapporto continuo tra parecchi operatori, dall'imprenditore all'ultimo operaio.” Achille Castiglioni

A partire dalle avanguardie artistiche del secolo scorso, il design italiano continua a ispirare movimenti, espressioni e modi d'essere che trovano nella linea italiana la manifestazione più autentica della cultura del progetto. Qual è, dunque, il segreto del design italiano? Dove si nasconde il suo intramontabile spirito che tutt'oggi continua a guidare l'evoluzione della disciplina? Dalla fiducia in un futuro migliore al rigore tecnologico; dalla volontà di sperimentare e mettersi in gioco all'inimitabile coerenza formale, la linea italiana rappresenta l'espressione materiale di un pensiero collettivo, condiviso all'unanimità tra i più importanti protagonisti dell'epoca. Pier Giacomo e Achille Castiglioni, Carlo De Carli e Gianfranco Frattini fanno parte di questo gruppo di progettisti illuminati del secolo scorso che hanno condiviso idee, pensieri e speranze per la disciplina progettuale, unendo il saper-fare manuale – caratteristico della produzione industriale del belpaese – all'ingegno tecnico, con la speranza di trasportare il mito del 'buon design' italiano nella realtà di tutti i giorni. Oggi, mezzo secolo dopo la loro creazione, i progetti realizzati da questi grandi maestri del passato continuano a rendere viva l'anima della linea italiana attraverso una serie di riedizioni realizzate da Tacchini, con la volontà di preservare e comunicare gli ideali che hanno guidato la loro creazione. Mantenendo l'integrità dei progetti originali, Tacchini ha adattato i disegni dei designer alla produzione odierna, trasportando la cultura del design dal passato alla contemporaneità.

Achille e Pier Giacomo Castiglioni

L'eroe del design italiano, Achille Castiglioni, assieme ai suoi fratelli Pier Giacomo e Livio, ha saputo trovare l'ironia e la bellezza nella semplicità della vita di tutti i giorni. Dai più banali interruttori elettrici ai progetti più iconici del design moderno, i fratelli Castiglioni hanno trasformato la loro incontrollabile curiosità in una serie di artefatti senza tempo. Tacchini propone la riedizione di due famosi pezzi di Achille Castiglioni, realizzati all'interno di un più ampio progetto dedicato alla riproduzione dei classici del design moderno. Babela, disegnata nel 1958 assieme al fratello Pier Giacomo, e Sancarolo, che vede luce per la prima volta nel 1970, riassumono lo spirito dell'epoca unendo la sperimentazione formale all'innovazione tecnica. Per Babela, una sedia impilabile disegnata in origine per la Camera di commercio di Milano, Achille e Pier Giacomo Castiglioni immaginano una torre fatta di sedute, facilmente trasportabili e impilabili, caratterizzata da un design lineare e archetipico, reso interessante da una particolare interazione tra materiali, texture visive ed effetti tattili. Sancarolo, dall'altro lato, gioca con forme organiche e tondeggianti per costruire una seduta flessibile e adattabile alle esigenze del corpo umano.

“L’esperienza non dà certezza né sicurezza, ma anzi aumenta la possibilità di errore. Direi che è meglio ricominciare ogni volta da capo con umiltà perché l’esperienza non rischi di tramutarsi in furbizia.”

Achille Castiglioni



03

Dai più banali interruttori elettrici ai progetti più iconici del design moderno, i fratelli Castiglioni hanno trasformato la loro incontrollabile curiosità in una serie di artefatti senza tempo.



04



05



06

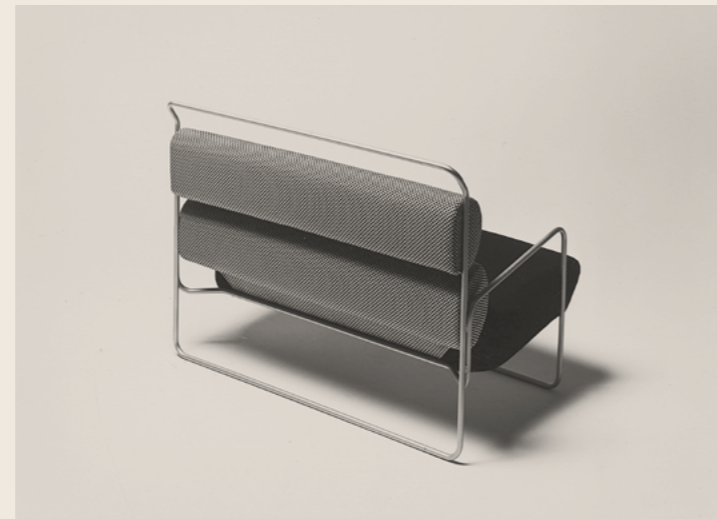

07

La poltrona Sancarlo è un trattato di statica, ergonomia, funzione e geometria. Incaricato a suo tempo da Driade, Achille Castiglioni recupera l'idea della Sanluca, disegnata qualche decennio prima con il fratello Pier Giacomo. Il risultato è la scomposizione della seduta in una serie di cuscini: che si offrono curvi a ognuna delle parti del corpo che dovranno sostenere.



08



09

06 - 09 Sancarlo (1970), divano e poltrona, immagini storiche.



10

Gianfranco Frattini è nato in Italia, a Padova, il 15 maggio 1926. Si è laureato con una laurea in architettura al Politecnico di Milano nell'anno 1953. Alla fine degli anni '50 è tra i fondatori dell'ADI, Associazione per il Disegno Industriale. Frattini apre il suo studio professionale a Milano, dopo aver lavorato nell'ufficio del suo maestro e mentore Giò Ponti. Nell'arco di pochi anni, diventa un designer industriale di fama internazionale.



11



12



13

10 Gianfranco Frattini, ritratto.
11 Agnese (1956), nominata per il Compasso d'Oro (© M. Masera).

Gianfranco Frattini
Gianfranco Frattini fa parte di quell'abile generazione di architetti e designer che hanno segnato il movimento del design italiano del secolo scorso. I progetti di Frattini vantano un'eleganza formale che comunica con chiarezza e semplicità le idee e le riflessioni che hanno portato alla loro creazione. Collaboratore di Giò Ponti all'inizio della carriera, Gianfranco Frattini svilupperà nel corso degli anni un personale e sintomatico approccio alla progettazione guidato da un'attenta ricerca formale e strutturale.

Agnese e Sesann condividono la stessa anima progettuale, declinata in due diverse configurazioni visive. Agnese, disegnata nel 1956 nello studio in via Sant'Agnese a Milano, nasce dall'idea di proporre l'archetipo della poltrona informale, caratterizzata da una seduta imbottita – geometrica ed essenziale – supportata da una base in legno classica e lineare. Sesann, dall'altro lato, presenta una forma organica e informale, realizzata avvolgendo una struttura in tubolare di metallo attorno a una morbida seduta imbottita.

Riedizione di un progetto originale di Gianfranco Frattini risalente al 1957, ma ancora attuale nelle forme e nello spirito, la poltrona Giulia fa rivivere nello spazio contemporaneo una sensazione senza tempo di bellezza, comfort ed armonia. Impeccabile la realizzazione, come nella tradizione Tacchini, dalla scelta dei materiali per la scocca dalle forme avvolgenti, alla base in legno di frassino tinto noce scuro o grigio, di sapore artigianale. Tratto da un classico del design italiano, progettato nel 1957 da Gianfranco Frattini e segnalato lo stesso anno per il Compasso D'Oro, Gio è un tavolo basso che esprime un'idea di rigore razionalista e di eleganza raffinata, suscitando l'emozione di una calda atmosfera borghese. È caratterizzato dalla lineare struttura in legno e dal piano bifacciale in frassino tinto noce scuro o grigio da un lato, oppure in laminato giallo, grigio, blu acciaio o effetto corno dall'altro.

Disegnato da Gianfranco Frattini nel 1957 e prodotto a partire dall'anno successivo, il divano Oliver ha riscosso negli anni un grandissimo successo. Essenziale ed elegante, è caratterizzato da una struttura leggera in acciaio con piedini terminali in legno e dall'imbottitura capitonné di seduta e schienale, un dettaglio di grande sapienza artigianale.

Lina è la riedizione di uno dei primi progetti disegnati da Gianfranco Frattini: segnalata nel 1955 per il Compasso d'Oro, la poltrona è caratterizzata da una struttura in legno molto particolare che le conferisce un aspetto solido eppure leggero. Merito delle gambe sottili e dell'elemento in multistrato curvato, che sorregge il fianco dello schienale e diventa al contempo ala d'appoggio dei braccioli. Una lavorazione molto innovativa

12 Lina (1955), immagine storica (© Archivio Frattini).
13 Gio (1957), immagine storica.

“Sono convinto che il punto di arrivo per il progettista sia l’incontro fra le nuove esigenze tecniche della produzione industriale e le nuove esigenze estetiche maturate con l’esperienza di questo attivissimo periodo creativo. Nei migliori esempi trapela anche, importantissima, non la negazione assoluta dei valori essenziali della tradizione, ma, anzi, il rispetto per quegli aspetti sempre validi che si possano evolvere nel tempo.”

Gianfranco Frattini in “Rivista dell’Arredamento” n.100, 1963



14



15

Proposta da Tacchini con una fedeltà filologica all’originale ed una realizzazione accurata in ogni dettaglio, accompagnata da un pouf coordinato, sempre su progetto originale di Gianfranco Frattini, la poltrona Agnese vuole essere solo l’inizio di un completo progetto di riscoperta dello stile di un grande designer e di un’intera atmosfera d’arredo.



16

14 Agnese e Giulia, immagini storiche (© Archivio Frattini).
15 Giulia (1957), immagine storica (© Archivio Frattini).
16 – 17 Sesann, divano e poltrona, immagini storiche (© Archivio Frattini).

Rispettando il pensiero di Gianfranco Frattini, la nuova riedizione di Sesann è stata realizzata mantenendo intatto lo spirito del prodotto. Caratterizzato da un rivestimento in tessuto o pelle, Sesann deve la sua tipica forma, soffice ed avvolgente, allo scheletro schiumato a freddo, contenuto da una struttura architettonica in tubolare di acciaio (cromato o verniciato), che poggia sui piedini in legno di frassino. La particolare configurazione di Sesann – allo stesso tempo formale e funzionale – costituisce le basi per un sistema di prodotti caratterizzati dagli stessi elementi strutturali, declinati, però, in oggetti unici e affascinanti. Questo approccio di sintesi e riduzione proposto da Frattini ha prodotto un design formalmente elegante, concettualmente elaborato e, soprattutto, irripetibile.



17



18

Per De Carli non esiste un diverso atteggiamento fra il progetto di una casa o di una sedia: "Ho l'amore per qualsiasi forma di architettura purché sia studiata, sperimentata, e sia essenziale (...) anche i mobili... ne ho disegnati molti... cercano solo la misura: non cercano alcun effetto... soprattutto la misura che trova relazione con lo spazio della casa, con il senso dell'albero." (Creatività, 1973)



19



20

Celebre designer, molto apprezzato anche come architetto, per i suoi progetti caratterizzati da una creatività totalizzante, che personalizza ogni dettaglio, dalla costruzione agli arredi, Eisler è anche scenografo e regista operistico. L'esperienza brasiliana approfondisce l'interesse di Martin Eisler per i legni esotici e le tecniche di verniciatura e laccatura di legno, vetro e bronzo.

per l'epoca, eseguita oggi con attenzione filologica. Poltrona di grande presenza, per il suo stile senza tempo Lina si abbina con naturalezza a tutti i divani della collezione Tacchini, sia in ambienti domestici che in aree contract.

Carlo De Carli

Nato a Milano, Carlo De Carli (1910-1999) si laurea nel 1934 in Architettura presso il Politecnico di Milano, lavora per un anno nello studio di Gio Ponti, cui nel 1962 succede nella cattedra di Architettura degli Interni, Arredamento e Decorazione. Curatore della X e XI Triennale di Milano è Preside della Facoltà di Architettura nel 1965-1968. Dal 1967 al 1971 dirige la rivista 'Interni'. Progetto, ricerca, didattica e promozione sono gli ambiti di azione del suo lavoro svolto in una sostanziale unità di pensiero attento alla persona e all'ambito sociale e produttivo in cui opera.

Testimone del concetto di "spazio primario" della filosofia di De Carli, ovvero dello "spazio di relazione", principi che trovano conferma nella visione della funzione d'arredo e della progettualità di interni secondo Tacchini, Sella è ispirato all'omonima poltrona disegnata nel 1966 dal celebre architetto italiano. Il divano si presenta come un arredo di grande eleganza, realizzato con materiali di assoluto pregio: legno di noce a vista, dettagli in elegante metallo cromato finitura nera lucido e cinghie di supporto dello schienale in raffinato cuoio. Le cuscinate sono in piuma e i rivestimenti possono essere in pelle, tessuto o velluto. La sua linea morbida e generosa è estremamente raffinata ed è progettata per regalare un comfort straordinario, dedicato a un tempo lento, che riconcilia con se stessi e con gli altri, nella dimensione di uno spazio di relazione più intimo e privato.

Max Eisler

Nato a Vienna nel 1913, figlio del famoso storico dell'arte Max Eisler, uno dei fondatori dell'Austrian Werkbund, Martin Eisler studia a Vienna come allievo dei noti architetti Oskar Strnad e Clemens Holzmeister. Nel 1938 si trasferisce a Buenos Aires, dove tiene subito la sua prima mostra di disegni e arredi presso la Galleria Mueller, che diventerà il futuro Salone delle Belle Arti nel 1940, presso il Palais de Glace. Nel 1945 fonda, insieme ad Arnold Hackel, Interieur, azienda che vende mobili e oggetti progettati dal duo, iniziando così la sua carriera di designer, che lo porterà anche in Brasile, dove nel 1955 si associa a Carlo Hauner della compagnia Moveis Artesanais, diventando Direttore Artistico della società Forma, a San Paolo.

18 Carlo De Carli, ritratto.
18 Sella, immagine storica (© Archivio De Carli).
20 Martin Eisler, ritratto.



21

Una poltrona elegante e informale allo stesso tempo. Dall'estetica sensuale, dalla matericità naturale e dal design intelligente, che consente una raffinata personalizzazione. Costela rappresenta la sintesi della natura di un progetto creativo.

Costela rappresenta la sintesi della natura di un progetto creativo. L'idea portante, dalla quale parte tutto, la bellissima struttura in legno a fasce arrotondate in un ideale abbraccio che accoglie sia nella seduta che nello schienale, e il completamento funzionale ed estetico del dettaglio, a garanzia di un comfort completo e dallo stile estremamente naturale nella loro posizione quasi casuale. La parte portante è facilmente smontabile e riciclabile, caratteristica in linea con la fondamentale tendenza e necessità contemporanee di produrre arredi che considerino i principi di sostenibilità e durata nel tempo. La possibilità di poter giocare con i rivestimenti tessili rende poi Costela non solo un pezzo dalla storia inconfondibile, ma anche un arredo di rinnovata e irresistibile tendenza.

Dinamica, flessibile, la riedizione di Reversível propone un doppio comfort grazie alla seduta posizionabile in due modi, per utilizzare la poltrona da seduti con schiena eretta, o in modo più rilassato in una posizione semi-sdraiata, trasversale allo schienale. La semplicità e la naturalezza del movimento ne fanno sembrare ovvia la funzionalità, che costituisce in realtà una intuizione assolutamente all'avanguardia oggi come ieri. Una seduta informale, dalle linee caratteristiche, con struttura in metallo e rivestimenti tessili che ne completano l'originalità. Reversível testimonia la morbidezza e la sensualità del design brasiliano anni '50, combinazione di tradizione e creatività, tra artigianato popolare e visionaria innovazione.

17 Costela (1952), foto storica.

Design



Maestri or “masters” are those charismatic figures capable of teaching and handing down an art through their direct actions and also through the inheritance of their actual works. In design the maestri communicate through the classics, timeless designs far from any idea of fashions and trends yet so powerful as to produce a style naturally. Tacchini has set aside some rooms in its living environment for the classics and the masters who have designed them, in a process of revivals which are a challenge and a lesson on contemporary style.

Classics

Starting from the avant-garde artistic groups of the last century, Italian design is an endless source of inspiration for movements, expressions and ways of being. They find the Italian line into the authentic manifestation of the culture of project. What is, then, the secret of Italian design? Where does its timeless spirit hide: a spirit that keeps on driving the evolution of the discipline? From the confidence in a better future to the technological precision; from the willingness to experiment and get involved to the inimitable formal coherence, the Italian line is the material expression of a collective thought, shared among the most important figures of that period. Achille and Pier Giacomo Castiglioni, Carlo De Carli, Gianfranco Frattini belong to this group of enlightened designers of the last century. They shared ideas, thoughts and hopes for the discipline of design. They were able to combine the manual know-how, related to the industrial production of belpaese with the technical science. Their hope was to translate the myth of the Italian “good design” into everyday reality.

Today, half a century after their creation, the projects realized by these great masters of the past continue to keep alive the soul of the Italian line through a series of revivals made by Tacchini. Tacchini proposes these pieces with the desire to preserve and communicate the ideals that have guided their creation. Maintaining the integrity of the original projects, Tacchini has adapted the designer’s drawings to modern production. In this way, it has transferred the past design culture to the present.

Achille and Pier Giacomo Castiglioni

The hero of Italian design, Achille Castiglioni, along with his brothers Pier Giacomo and Livio, was able to find irony and beauty into the simplicity of everyday life. From the simplest electrical switches to the most iconic project of modern design, Castiglioni brothers transformed their uncontrollable curiosity in a series of timeless pieces. Tacchini proposes the revival of two famous pieces of Achille Castiglioni, realized inside a larger project dedicated to the reproduction of classics of modern design. Babela, designed in 1958 along with his brother Pier Giacomo, and Sancarlo, created for the first time in 1970, sum up the spirit of the period joining the formal experimentation to technical innovation. Achille and Pier Giacomo Castiglioni designed Babela, a

stackable chair, for the Milan chamber of commerce. They imagined a tower made by seats, stackable and easily transportable. Its design was simple and archetypical, with a particular mixture of materials, visual texture and tactile effects. On the other hand, Sancarlo, plays with rounded and organic shapes to allow a flexible seat, and, at the same time, suitable to the comfort of person.

Gianfranco Frattini

Gianfranco Frattini is one of that skilled generation of architects and designers, who have marked the Italian design movement of the last century. Frattini’s projects are characterized by a formal elegance, which is able to transmit clearly, and simply the ideas and thoughts that led to their creation. At the beginning of his career, he was a collaborator of Giò Ponti. Over the years, Gianfranco Frattini will develop a personal and symptomatic approach to the design based on a careful formal and structural research.

Agnese and Sesann have the same soul of design, with two different visual configurations. Designed in 1956, in the studio in via Sant’Agnese in Milan, Agnese comes out from the idea to realize the archetype of the informal armchair. It is characterized by an upholstery seat – geometric and basic – with a classical linear and wooden base. On the other hand, Sesann is characterized by an organic and informal shape, made by wrapping a tubular metal around a soft and upholstered seat.

Relaunch of an original project of Gianfranco Frattini dated 1957, but still actual for its shapes and spirit, Giulia armchair creates in the contemporary space a timeless feeling of beauty, comfort and harmony. A flawless realization, typical of Tacchini’s tradition, from the choice of materials for the embrace-shaped structure, to the ash wood basis dyed dark walnut or grey with artisan taste.

Inspired by a classic piece of Italian design designed in 1957 by Gianfranco Frattini and nominated the same year for Compasso d’Oro, Gio is a low table which expresses an idea of rationalist rigor and refined elegance, creating the emotion of a warm bourgeois atmosphere. It is characterized by the linear wood structure and by the ash double face plan dyed dark walnut or grey on one side, or yellow, grey or steel blue laminated on the other side.

Designed by Gianfranco Frattini in 1957 and produced as from the following year, Oliver sofa has achieved a huge success over the years. Minimalist and elegant, it features a lightweight structure in steel with end feet in wood and tufted upholstery on the seat and back, a detail requiring great craft expertise.

Carlo De Carli

Born in Milan, Carlo De Carli (1910-1999) graduated in 1934 in architecture from the Polytechnic University of Milan, worked for a year in the

studio of Gio Ponti and took over the chair in interior architecture, furniture and decoration from him in 1962. Curator of the X and XI Milan Triennale, he was head of the architecture faculty from 1965 to 1968. Editor of the magazine Interni from 1967 to 1971. Design, research, teaching and promotion were the areas of action of his work, carried out with a broad communality of thinking and focused on people and the social and production context in which they operate.

Sella illustrates the concept of “primary space” from De Carli’s philosophy – that of a “relational space” –, a principle true to Tacchini’s vision of the function of furniture and interior design. The highly elegant sofa is made using the very finest of materials: exposed walnut, elegant metal chromed details finish shiny black and belts for the support of the backrest in refined natural leather. The cushions are filled with feathers, and the coverings could be in leather, fabric or velvet. Its soft, generous line offers the utmost refinement, and is designed to guarantee extraordinary comfort, conducive to a slow tempo that will reconcile us with ourselves and others, in a more intimate and private spatial dimension.

Max Eisler

Born in Vienna in 1913, the son of the famous art historian Max Eisler, one of the founding members of the Austrian Werkbund, Martin Eisler studied in Vienna under the noted architects Oskar Strnad and Clemens Holzmeister.

Costela is a paradigm of creative design. The fundamental idea on which the chair is built is the beautiful wooden structure with its wooden ribs embracing both the seat and the back, and the functional and aesthetic completion of the detail, the large cushions, set horizontally and vertically, ensuring absolute comfort with an extremely natural style in their almost random position. The structure is easy to dismantle and recycle, a characteristic perfect for the current need and tendency to produce furniture that gives due consideration to the principles of sustainability and durability. The possibility to play with the fabric coverings makes Costela not only an unmistakable piece of history, but also an item of renewed and irresistible modernity.

The dynamic, flexible reissue of Reversível offers dual comfort with two possible seat positions, to sit in the chair with the back upright, or really relax in a semi-reclining position, parallel with the backrest. The simple, natural movement makes it seem an obvious solution, but it actually represents as ground-breaking an intuition now as then. This original, informal seat with its distinctive lines is completed with a metal structure and fabric coverings. Reversível bears witness to the soft, sensuality of Brazilian 1950s design, a combination of tradition and creativity, folk craft and visionary innovation.

Armchairs

| | | | | |
|-----|------------|-------------------------|-------------------------|--------------------|
| 038 | Agnese | Gianfranco Frattini | Armchair, Ottoman | Domestic, Contract |
| 126 | Baobab | Lievore Altherr Molina | Armchair | Domestic, Contract |
| 026 | Costela | Martin Eisler | Armchair, Ottoman | Domestic, Contract |
| 108 | Crystal | PearsonLloyd | Armchair | Contract |
| 082 | Doodle | Claesson Koivisto Rune | Armchair | Domestic, Contract |
| 090 | Dot | Patrick Norguet | Armchair | Domestic, Contract |
| 166 | Girola | Lievore Altherr Molina | Armchair | Domestic, Contract |
| 044 | Giulia | Gianfranco Frattini | Armchair, Ottoman | Domestic, Contract |
| 156 | Glide | Monica Förster | Armchair | Domestic |
| 114 | Isola | Claesson Koivisto Rune | Armchair | Contract |
| 094 | Jacket | Patrick Norguet | Armchair | Domestic, Contract |
| 072 | Kelly E | Claesson Koivisto Rune | Armchair | Domestic, Contract |
| 072 | Kelly H | Claesson Koivisto Rune | Armchair | Domestic, Contract |
| 054 | Lagoa | Zanini De Zanine | Armchair | Contract |
| 032 | Lina | Gianfranco Frattini | Armchair | Domestic, Contract |
| 138 | Mayfair | Christophe Pillet | Armchair, Sofa | Domestic, Contract |
| 150 | Misura S/M | Claesson Koivisto Rune | Armchair | Contract |
| 144 | Moon | Pietro Arosio | Armchair | Domestic, Contract |
| 132 | Parentesi | Pietro Arosio | Armchair | Contract |
| 060 | Pastilles | Studiopepe | Armchair | Domestic, Contract |
| 100 | Pisa | Claesson Koivisto Rune | Armchair | Domestic, Contract |
| 018 | Reversível | Martin Eisler | Armchair | Domestic |
| 120 | Sancarlo | Achille Castiglioni | Armchair, Sofa | Domestic, Contract |
| 050 | Sesann | Gianfranco Frattini | Armchair, Sofa ↗ Vol. A | Domestic, Contract |
| 066 | Shelter | Noé Duchaufour-Lawrance | Armchair, Ottoman | Domestic, Contract |
| 170 | SouthBeach | Christophe Pillet | Armchair | Domestic, Contract |
| 162 | XL | Pietro Arosio | Armchair | Contract |

Ottomans

| | | | | |
|-----|-----------|------------------------|---------|--------------------|
| 060 | Pastilles | Studiopepe | Ottoman | Domestic, Contract |
| 176 | Quartier | Claesson Koivisto Rune | Ottoman | Domestic, Contract |
| 182 | Spin | Claesson Koivisto Rune | Ottoman | Domestic, Contract |

Chaises-longues

| | | | | |
|-----|-----------|------------------------|---------------|--------------------|
| 186 | Atoll | Patrick Norguet | Chaise-longue | Domestic, Contract |
| 072 | Kelly L+F | Claesson Koivisto Rune | Chaise-longue | Domestic, Contract |
| 082 | Doodle | Claesson Koivisto Rune | Chaise-longue | Domestic, Contract |
| 192 | Slalom | Pietro Arosio | Chaise-longue | Domestic, Contract |

Chairs

| | | | | |
|-----|-----------------|------------------------------------|-----------------------------------------------------------|--------------------|
| 216 | Babela | Achille + Pier Giacomo Castiglioni | Chair | Domestic, Contract |
| 228 | Doodle | Claesson Koivisto Rune | Chair | Domestic, Contract |
| 240 | Eddy | PearsonLloyd | Chair | Contract |
| 202 | Kelly C/C Basic | Claesson Koivisto Rune | Chair | Domestic, Contract |
| 210 | Kelly V | Claesson Koivisto Rune | Chair | Domestic, Contract |
| 246 | Mayfair | Christophe Pillet | Chair | Domestic, Contract |
| 196 | Memory Lane | Christophe Pillet | Chair | Domestic, Contract |
| 222 | Montevideo | Claesson Koivisto Rune | Chair, Sofa ↗ Vol. A, Armchair ↗ Vol. A, Ottoman ↗ Vol. A | Domestic, Contract |
| 234 | T-Chair | B/M | Chair | Domestic, Contract |

Stools

| | | | | |
|-----|---------|------------------------|-------|--------------------|
| 228 | Doodle | Claesson Koivisto Rune | Stool | Domestic, Contract |
| 252 | Fixie | PearsonLloyd | Stool | Contract |
| 072 | Kelly S | Claesson Koivisto Rune | Stool | Domestic, Contract |

Tables

| | | | | |
|-----|---------|------------------------|-------|--------------------|
| 266 | Kelly T | Claesson Koivisto Rune | Table | Domestic, Contract |
| 274 | Spindle | Gordon Guillaumier | Table | Domestic, Contract |
| 260 | Split | Claesson Koivisto Rune | Table | Domestic, Contract |

Low Tables

| | | | | |
|-----|---------------|------------------------|-----------|--------------------|
| 302 | Cage | Gordon Guillaumier | Low Table | Domestic, Contract |
| 308 | Coot | Gordon Guillaumier | Low Table | Domestic, Contract |
| 286 | Gio | Gianfranco Frattini | Low Table | Domestic, Contract |
| 282 | Joaquim | Giorgio Bonaguro | Low Table | Domestic, Contract |
| 296 | Kelly B/O/W | Claesson Koivisto Rune | Low Table | Domestic, Contract |
| 320 | Labanca Table | Lievore Altherr Molina | Low Table | Domestic, Contract |
| 316 | Ledge | Gordon Guillaumier | Low Table | Contract |
| 324 | Nara | Lievore Altherr Molina | Low Table | Domestic, Contract |
| 060 | Pastilles | Studiopepe | Low Table | Domestic, Contract |
| 312 | Polar Table | PearsonLloyd | Low Table | Domestic, Contract |
| 290 | Soap | Gordon Guillaumier | Low Table | Domestic, Contract |
| 260 | Split | Claesson Koivisto Rune | Low Table | Domestic, Contract |

Technical informations

Armchairs

| | |
|-----|------------|
| 329 | Agnese |
| 329 | Baobab |
| 329 | Costela |
| 329 | Crystal |
| 340 | Doodle |
| 330 | Dot |
| 330 | Girola |
| 330 | Giulia |
| 331 | Glide |
| 331 | Isola |
| 332 | Jacket |
| 332 | Kelly E |
| 332 | Kelly H |
| 333 | Lagoa |
| 333 | Lina |
| 333 | Mayfair |
| 334 | Misura S/M |
| 334 | Moon |
| 334 | Parentesi |
| 335 | Pastilles |
| 335 | Pisa |
| 335 | Reversível |
| 336 | Sancarlo |
| 336 | Sesann |
| 337 | Shelter |
| 337 | SouthBeach |
| 338 | XL |

Ottomans

| | |
|-----|-----------|
| 335 | Pastilles |
| 338 | Quartier |
| 338 | Spin |

Chaises-longues

| | |
|-----|-----------|
| 339 | Atoll |
| 332 | Kelly L+F |
| 340 | Doodle |
| 339 | Slalom |

Chairs

| | |
|-----|-----------------|
| 339 | Babela |
| 340 | Doodle |
| 341 | Eddy |
| 342 | Kelly C/C Basic |
| 343 | Kelly V |
| 333 | Mayfair |
| 343 | Memory Lane |
| 344 | Montevideo |
| 344 | T-Chair |

Stools

| | |
|-----|---------|
| 340 | Doodle |
| 341 | Fixie |
| 332 | Kelly S |

Tables

| | |
|-----|---------|
| 345 | Kelly T |
| 347 | Spindle |
| 348 | Split |

Low Tables

| | |
|-----|---------------|
| 349 | Cage |
| 348 | Coot |
| 350 | Gio |
| 350 | Joaquim |
| 351 | Kelly B/O/W |
| 352 | Labanca Table |
| 352 | Ledge |
| 353 | Nara |
| 335 | Pastilles |
| 353 | Polar Table |
| 354 | Soap |
| 347 | Split |

Object, Stories

Vol. B, Catalogue

Domestic

Armchair

Reversível

Firmata dalla geniale creatività dell'architetto e designer Martin Eisler, Reversível, pezzo storico del design carioca, ha fatto innamorare Tacchini per la sua incredibile innovazione.

Informazioni → p.025

Nella semplicità di una linea e di un movimento, questa poltrona si trasforma con un'eleganza estremamente disinvolta. Dinamica, flessibile, la riedizione di Reversível propone un doppio comfort grazie alla seduta posizionabile in due modi, per utilizzare la poltrona da seduti con schiena eretta, o in modo più rilassato in una posizione semi-sdraiata, trasversale allo schienale. La semplicità e la naturalezza del movimento ne fanno sembrare ovvia la funzionalità, che costituisce in realtà una intuizione assolutamente all'avanguardia oggi come ieri. Una seduta informale, dalle linee caratteristiche, con struttura in metallo e rivestimenti tessili che ne completano l'originalità. Reversível testimonia la morbidezza e la sensualità del design brasiliano anni '50, combinazione di tradizione e creatività, tra artigianato popolare e visionaria innovazione.

Awards: 2019 Archiproducts Design Awards

Designer, Year:
Martin Eisler, (1955) 2019









Reversível

Design Classic ↗ p.002
Discover Tacchini
process of re-editions

En Fruit of the creative genius of the architect and designer Martin Eisler, Reversível is an historic piece of Carioca design, and Tacchini fell in love with its incredibly innovative style. With the simplicity of its lines and movement, this armchair transforms with casual elegance. The dynamic, flexible reissue of Reversível offers dual comfort with two possible seat positions, to sit in the chair with the back upright, or really relax in a semi-reclining position, parallel with the backrest. The simple, natural movement makes it seem an obvious solution, but it actually represents as ground-breaking an intuition now as then. This original, informal seat with its distinctive lines is completed with a metal structure and fabric coverings. Reversível bears witness to the soft, sensuality of Brazilian 1950s design, a combination of tradition and creativity, folk craft and visionary innovation.

De Reversível, ein historisches Werk des brasilianischen Designs, aus der genialen, kreativen Feder des Architekten und Designers Martin Eisler, bezauberte Tacchini mit seinem unglaublich innovativen Stil. Mit seiner schlichten Linienführung und einer einfachen Bewegung verwandelt sich dieser Sessel mit extrem nonchalanter Eleganz. Die Neuausgabe von Reversível, dynamisch und flexibel, bietet mit zwei verschiedenen Positionen des Sitzes doppelten Komfort, so dass man auf dem Sessel aufrecht sitzen, oder sich halbliegend quer zur Rückenlehne entspannen kann. Die einfache, leichte Bewegung lässt die Funktionalität beider Positionen absolut normal erscheinen, während es sich aber in Wirklichkeit um eine, heute und gestern, absolut avantgardistische Intuition handelt. Ein informell zwangloser Sitz mit charaktvoller Linie, einer Metallstruktur und Stoffbezügen, die ihn noch origineller machen. Reversível ist ein Beispiel für die sinnliche Schmiegsamkeit des brasilianischen Designs der fünfziger Jahre, ein Zusammenfließen von Tradition und Kreativität, zwischen volkstümlichem Handwerk und visionärer Innovation.

Fr Fruit de la créativité géniale de l'architecte et designer Martin Eisler et pièce historique du design Carioca, Reversível a séduit Tacchini par son extraordinaire innovation. La simplicité d'une ligne et d'un mouvement permet de transformer ce fauteuil avec une élégance extrêmement décontractée. Dynamique et flexible, la réédition de Reversível offre un double confort grâce à son assise mobile à deux positions : l'une, assise avec le dos droit, l'autre, plus décontractée, semi-allongée transversalement au dossier. La simplicité et le naturel du mouvement rendent sa fonctionnalité évidente, révélant en réalité une intuition aussi avant-gardiste aujourd'hui qu'hier. Ce siège informel, aux lignes caractéristiques, arbore une structure en métal et des revêtements textiles qui en complètent l'originalité. Reversível témoigne de la douceur et de la sensualité du design brésilien des années 1950, alliant la tradition à la créativité, entre artisanat populaire et innovation visionnaire.



Martin Eisler

Born in Vienna in 1913, the son of the famous art historian Max Eisler, one of the founding members of the Austrian Werkbund, Martin Eisler studied in Vienna under the noted architects Oskar Strnad and Clemens Holzmeister. In 1938 he moved to Buenos Aires, where he immediately set about holding his first exhibition of designs and furniture at the Mueller Gallery, which became the National Office of Fine Arts in 1940, in the Palais de Glace. His work also took him to Brazil, where in 1955 he went into partnership with Carlo Hauner from the company Moveis Artesanais, and became Art Director of the company Forma in São Paulo. Eisler's experience in Brazil aroused his interest in exotic woods and varnishing and lacquering techniques on wood, glass and bronze. Also greatly appreciated as an architect for his projects characterised by their all-encompassing creativity, which customised every detail, from buildings to furniture, Eisler also worked as a set designer and opera director.

Other products by Martin Eisler:
Costela ↗ p.026

Technical informations



Armchair ↗ p.335

Costela

Icona del design brasiliano degli anni '50, Tacchini ha il piacere di rieditare Costela di Martin Eisler. Una poltrona elegante e informale allo stesso tempo. Dall'estetica sensuale, dalla matericità naturale e dal design intelligente, che consente una raffinata personalizzazione.

Informazioni → p.031



Costela rappresenta la sintesi della natura di un progetto creativo. L'idea portante, dalla quale parte tutto, la bellissima struttura in legno a fasce arrotondate in un ideale abbraccio che accoglie sia nella seduta che nello schienale, e il completamento funzionale ed estetico del dettaglio, a garanzia di un comfort completo e dallo stile estremamente naturale nella loro posizione quasi casuale. La parte portante è facilmente smontabile e riciclabile, caratteristica in linea con la fondamentale tendenza e necessità contemporanee di produrre arredi che considerino i principi di sostenibilità e durata nel tempo. La possibilità di poter giocare con i rivestimenti tessili rende poi Costela non solo un pezzo dalla storia inconfondibile, ma anche un arredo di rinnovata e irresistibile tendenza.

Designer, Year:
Martin Eisler, (1952) 2019



Costela

Design Classic ↗ p.002
Discover Tacchini
process of re-editions



Costela (Armchair), structure T115 Walnut
W 74 D 80 H 83 H seat 40 cm

Costela (Ottoman), structure T115 Walnut
W 74 D 55 H 40 cm

En Tacchini is delighted to reissue Costela by Martin Eisler, an icon of Brazilian 1950s design. An elegant yet informal armchair. With its sensual aesthetic, natural materials and intelligent design, it offers sophisticated personalization. Costela is a paradigm of creative design. The fundamental idea on which the chair is built is the beautiful wooden structure with its wooden ribs embracing both the seat and the back, and the functional and aesthetic completion of the detail, ensuring absolute comfort with an extremely natural style in their almost random position. The structure is easy to dismantle and recycle, a characteristic perfect for the current need and tendency to produce furniture that gives due consideration to the principles of sustainability and durability. The possibility to play with the fabric coverings makes Costela not only an unmistakable piece of history, but also an item of renewed and irresistible modernity.

De Tacchini nimmt mit Begeisterung die Idee auf, Costela von Martin Eisler neu herauszugeben, eine Ikone des brasilianischen Designs der fünfziger Jahre. Ein eleganter und gleichzeitig informeller Sessel, ästhetisch attraktiv, mit natürlichen Materialcharakteristiken und intelligentem Design, der raffinierte persönlich gestaltete Variationen erlaubt. Costela stellt eine Synthese des wahren Wesens eines kreativen Projekts dar. Die tragende Idee, der Ausgangspunkt, ist die elegante Struktur aus gerundeten Holzleisten, eine einladende Umarmung, die den Körper auf dem Sitz und an der Rückenlehne aufnimmt. Dieses Detail wird funktionell und ästhetisch vervollständigt und vollen Komfort garantieren, mit extrem natürlichem Stil, da ihre Positionierung fast unbewusst und zufällig erscheint. Das tragende Gestell ist leicht auseinander zu nehmen und ist wiederverwertbar, eine Charakteristik im Einklang mit der grundlegenden Tendenz und der Notwendigkeit unserer Zeit, Einrichtungsstücke herzustellen, die den Prinzipien der Nachhaltigkeit und der zeitlichen Dauerhaftigkeit entsprechen. Die Möglichkeit, mit verschiedenen Stoffbezügen zu spielen, macht Costela nicht nur zu einem unverkennbaren, historischen Möbel, sondern auch zu einem Einrichtungsobjekt von erneuerter, unwiderstehlicher Tendenz.

Fr Tacchini a le plaisir de rééditer Costela de Martin Eisler, une icône du design brésilien des années 1950. Un fauteuil à la fois élégant et informel. Son esthétique sensuelle, sa matérialité naturelle et son design intelligent permettent une personnalisation raffinée. Costela représente la synthèse de la nature d'un projet créatif. L'idée principale qui sous-tend le tout, à savoir la superbe structure en lattes de bois arrondies, telle une étreinte idéale qui accueille à la fois dans l'assise et le dossier, et le complément fonctionnel et esthétique du détail, presque aléatoire garantit un confort total et un style extrêmement naturel. La structure porteuse est facilement démontable et recyclable, une caractéristique conforme à la tendance fondamentale et au besoin contemporain de produire des meubles tenant compte des principes de durabilité et de durée dans le temps. La possibilité de pouvoir jouer avec les revêtements textiles fait de Costela non seulement une pièce dotée d'une histoire incomparable, mais aussi un meuble d'une tendance rénovée et irrésistible.



Martin Eisler

Born in Vienna in 1913, the son of the famous art historian Max Eisler, one of the founding members of the Austrian Werkbund, Martin Eisler studied in Vienna under the noted architects Oskar Strnad and Clemens Holzmeister. In 1938 he moved to Buenos Aires, where he immediately set about holding his first exhibition of designs and furniture at the Mueller Gallery, which became the National Office of Fine Arts in 1940, in the Palais de Glace. His work also took him to Brazil, where in 1955 he went into partnership with Carlo Hauner from the company Moveis Artesanais, and became Art Director of the company Forma in São Paulo. Eisler's experience in Brazil aroused his interest in exotic woods and varnishing and lacquering techniques on wood, glass and bronze. Also greatly appreciated as an architect for his projects characterised by their all-encompassing creativity, which customised every detail, from buildings to furniture, Eisler also worked as a set designer and opera director.

Other products by Martin Eisler:
Reversível ↗ p.018

Technical informations



Armchair, Ottoman ↗ p.329

Lina

Lina è la riedizione di uno dei primi progetti disegnati da Gianfranco Frattini, uno dei grandi maestri del design italiano.

Informazioni → p.037



Segnalata nel 1955 per il Compasso d'oro, la poltrona è caratterizzata da una struttura in legno molto particolare che le conferisce un aspetto solido eppure leggero. Merito delle gambe sottili e dell'elemento in multistrato curvato, che sorregge il fianco dello schienale e diventa al contempo ala d'appoggio dei braccioli. Una lavorazione molto innovativa per l'epoca, eseguita oggi con attenzione filologica. Poltrona di grande presenza, per il suo stile senza tempo Lina si abbina con naturalezza a tutti i divani della collezione Tacchini, sia in ambienti domestici che in aree contract.

Designer, Year:
Gianfranco Frattini, (1955) 2018

Lina (Armchair),
base T43 Dark Walnut
W 78 D 78 H 76 cm
H seat 41 cm

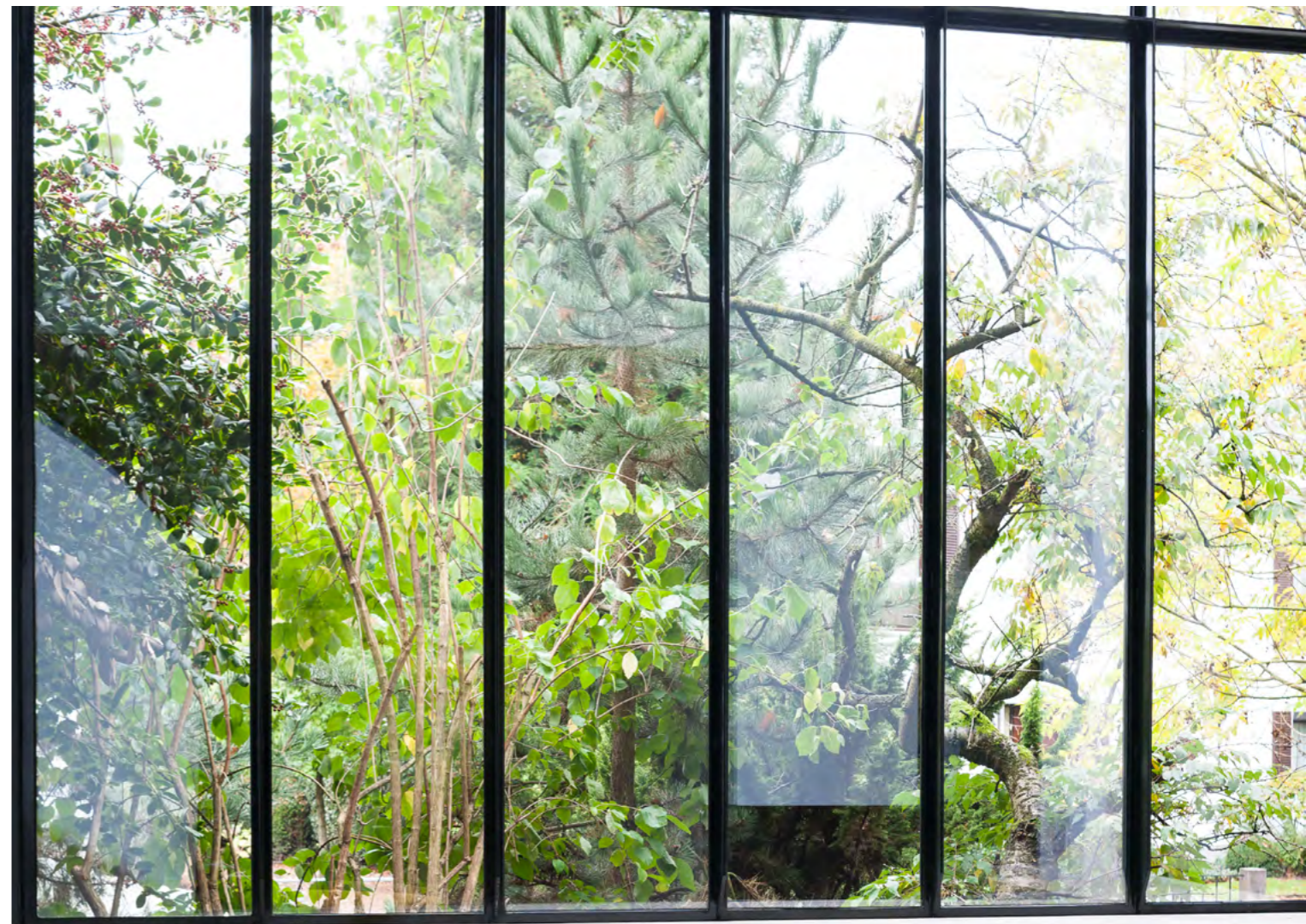

Lina (Armchair),
base T43 Dark Walnut
W 78 D 78 H 76 cm
H seat 41 cm

Joaquim (Low Table), top
T119 Elegant Brown Marble,
base T27 Matt Black
Chrome ↗ p.282



Lina (Armchair),
base T43 Dark Walnut
W 78 D 78 H 76 cm
H seat 41 cm

Lina

Design Classic ↗ p.002
Discover Tacchini
process of re-editions

En Lina is a re-edition of one of the earliest projects designed by Gianfranco Frattini, one of the great masters of Italian design. Nominated in 1955 for the Compasso d'oro, the armchair features an unusual wood frame that lends it a solid, yet lightweight, appearance. Its singularity lies in the slender legs and bent plywood element that supports the side of the seat back and curves up to become the 'wing' upon which the armrests sit. A very innovative workmanship technique for its time, carried out today with historical accuracy. An armchair that makes a bold statement, thanks to its timeless style, Lina can be paired with unaffected ease with all the sofas in the Tacchini collection, in residential and contract settings.

De Lina ist eine Neuauflage eines der ersten Entwürfe von Gianfranco Frattini, diesem großen Meister des italienischen Designs. 1955 für den Compasso d'Oro nominiert, zeichnet sich der Lehnstuhl durch ein sehr spezielles Gestell aus, das ihm ein solides aber dennoch anmutiges Aussehen verleiht. Das liegt an den schlanken Beinen und dem Element aus gebogener Mehrschichtplatte, die seitlich die Rückenlehne stützt und gleichzeitig als geschwungene Auflage für die Armlehnen genutzt wird. Eine für die damalige Zeit innovative Fertigung, die heute mit philologischer Sorgfalt wiederholt wird. Mit dem zeitlosen Stil ist Lina ein attraktiver Blickfang, der sich wie selbstverständlich mit allen Sofas der Kollektion Tacchini sowohl im Wohn- wie im Objektbereich kombinieren lässt.

Fr Lina est la réédition de l'un des premiers projets dessinés par Gianfranco Frattini, l'un des grands maîtres du design italien. Signalé en 1955 pour le Compasso d'oro, le fauteuil est caractérisé par une structure en bois très particulière qui lui donne un aspect solide tout en restant léger. Ce résultat est lié à la finesse des pieds et à l'élément en multiples courbes, qui soutient le côté du dossier tout en servant d'appui aux accoudoirs. Un façonnage très innovant pour l'époque, exécuté aujourd'hui avec une attention philologique. Fauteuil d'une grande présence, grâce à son style intemporel Lina peut être associé sans problèmes à tous les canapés de la collection Tacchini, aussi bien dans les espaces domestiques que collectifs.



Gianfranco Frattini

Gianfranco Frattini was born in Padua, Italy, on 15th May, 1926. He graduated in Architecture, at the Politecnico, Milan, in 1953. At the end of the 50's, he is one of the founders of ADI, Association for Industrial Design. Frattini opened his own studio in Milan, after working in the office of his teacher and mentor Gio Ponti. In few years, he became an industrial designer, well-known worldwide. Among his many successful projects, in 1956 designed the chair model 849, nominated for the "Compasso d'Oro" Prize. Now, this armchair, which takes shapes from the original design, is proposed by Tacchini with the name of "Agnese".

Other products by Gianfranco Frattini:
Agnese ↗ p.038, Gio ↗ p.286, Giulia ↗ p.044,
Oliver ↗ Vol. A p.050, Sesann (Sofa) ↗ Vol. A p.026,
Sesann (Armchair) ↗ p.050

Technical informations



Armchair ↗ p.333

Agnese

Una delle poltrone più celebri disegnate da Gianfranco Frattini, il modello 849 del 1956. Agnese è un'icona del design italiano dall'allure intramontabile, nominata con segnalazione d'onore al III Compasso d'Oro.

Informazioni → p.043

La sua innovazione continua oggi a essere esemplare. Seduta e schienale imbottiti sono sostenuti dalla struttura portante in legno di frassino. L'accostamento dei diversi materiali, il contrasto tra l'elemento geometrico della base e quello morbido della parte imbottita, i dettagli costruttivi straordinariamente semplici nella loro particolarità, rappresentano la firma unica di un Maestro della storia del design. All'estetica elegante e riconoscibile, Agnese unisce ergonomia e funzionalità senza tempo. La seduta può essere accompagnata dal pouf imbottito coordinato.

Designer, Year:
Gianfranco Frattini, (1956) 2014

Agnese (Armchair),
base T49 Grey
W 84 D 76 H 73 cm
H seat 44 cm

Agnese (Ottoman),
base T49 Grey
W 57 D 51 H 42 cm

Cage (Low Table), top T41
Smoked Mirror, base
T28 Polished Black Chrome
→ p.302



Agnese (Armchair),
base T43 Dark Walnut
W 84 D 76 H 73 cm
H seat 44 cm

Agnese (Ottoman),
base T43 Dark Walnut
W 57 D 51 H 42 cm



Agnese (Armchair),
base T43 Dark Walnut
W 84 D 76 H 73 cm
H seat 44 cm

Agnese (Ottoman),
base T43 Dark Walnut
W 57 D 51 H 42 cm

Agnese

Design Classic ↗ p.002
Discover Tacchini
process of re-editions

Agnese is the name of the new version of the 849, the armchair designed by Gianfranco Frattini around 1956 in his Milan studio, in via Sant'Agnese in fact. All the style and radiance of an age take shape in the lines of this armchair which is much more than a classic and almost an archetype. Agnese, the armchair, is produced in a very accurate way and with extreme fidelity to the original design; moreover, following from Frattini's original project, the armchair is accompanied by a matching ottoman. Agnese is just the beginning of a comprehensive project that aims to support the revival of a great designer's style but also an entire atmosphere of interior decor.

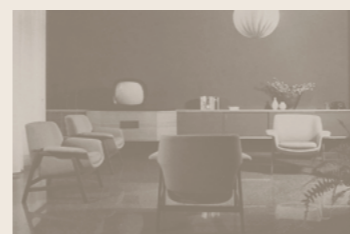

Gianfranco Frattini

Gianfranco Frattini was born in Padua, Italy, on 15th May, 1926. He graduated in Architecture, at the Politecnico, Milan, in 1953. At the end of the 50's, he is one of the founders of ADI, Association for Industrial Design. Frattini opened his own studio in Milan, after working in the office of his teacher and mentor Gio Ponti. In few years, he became an industrial designer, well-known worldwide. Among his many successful projects, in 1956 designed the chair model 849, nominated for the "Compasso d'Oro" Prize. Now, this armchair, which takes shapes from the original design, is proposed by Tacchini with the name of "Agnese".

Other products by Gianfranco Frattini:
Gio ↗ p.286, Giulia ↗ p.044, Lina ↗ p.032,
Oliver ↗ Vol. A p.050, Sesann (Sofa) ↗ Vol. A p.026,
Sesann (Armchair) ↗ p.050

En Model 849, one of his most famous armchairs, was designed by Gianfranco Frattini in 1956. Awarded honorable mention at the 3rd Compasso d'Oro, Agnese is an Italian design icon whose appeal is timeless. His spirit of innovation is exemplary, even today. The upholstered seat and backrest are supported by an ash wood structure. The combination of the various materials, the contrast between the geometric lines of the base and the soft cushioned parts, the extraordinarily simple construction details in their uniqueness represent the signature style of a true master of design. Agnese blends timeless ergonomics and functionality with elegant, recognizable aesthetics. Perfect complement to the armchair is the matching upholstered ottoman.

De Einer der berühmtesten Sessel des Designers Gianfranco Frattini ist das Modell 849 aus dem Jahr 1956. Der Loungesessel Agnese ist eine italienische Designikone mit zeitlosem Charme und wurde mit einer ehrenvollen Erwähnung für den III Compasso d'Oro nominiert. Das innovative Design ist auch heute noch exemplarisch. Die gepolsterte Sitzfläche und Rückenlehne werden von einem Gestell aus Eschenholz getragen. Die Kombination des geometrischen Elements, das vom Gestell gebildet wird, mit weichen Polster-elementen und gestalterischen Details, die in ihrer Besonderheit außerordentlich schlicht sind, sind das Markenzeichen dieses großartigen Designers. Agnese verbindet die elegante Ästhetik mit hohem Wiedererkennungswert mit Ergonomie und zeitloser Funktionalität. Passend zum Armsessel gibt es auch einen Polsterhocker.

Fr Le modèle 849 de 1956 est l'un des fauteuils les plus célèbres que Gianfranco Frattini a dessinés. L'esprit intemporel d'Agnese en fait une icône du design italien, récipiendaire d'une mention d'honneur au 3ème Compasso d'Oro. Son innovation continue d'être exemplaire aujourd'hui. L'assise et le dossier rembourrés sont soutenus par une structure en bois de frêne. La juxtaposition des différents matériaux, le contraste entre la géométrie du piètement et la souplesse de la partie rembourrée, les détails de construction extrêmement simples dans leur originalité, représentent la signature unique d'un Maître de l'histoire du design. Agnese allie une ergonomie et une fonctionnalité intemporelle à une esthétique élégante et reconnaissable. Le siège peut être assorti du pouf rembourré coordonné.

Technical informations

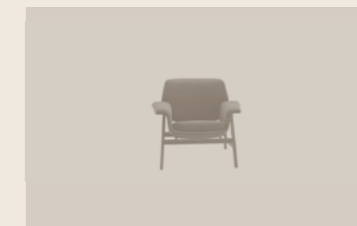

Armchair ↗ p.329

Giulia

Riedizione del celebre modello 877 di Gianfranco Frattini, del 1957, dedicato dal designer alla moglie di Gio Ponti, suo grande Maestro. Giulia è l'interpretazione moderna di Frattini della classica poltrona bergère e fa parte dei modelli storici del design made in Italy.

Informazioni → p.049

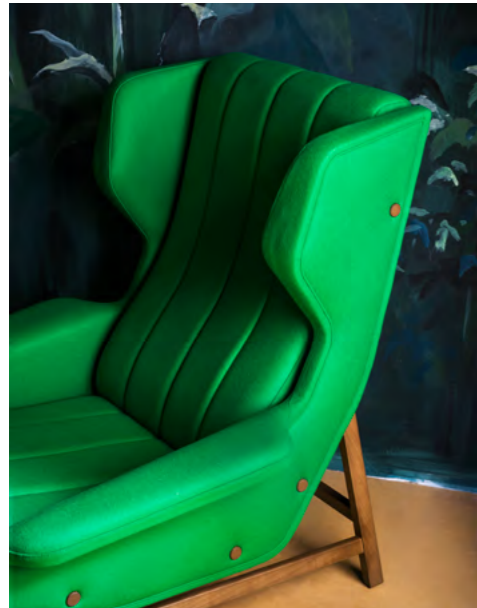

Designer, Year:
Gianfranco Frattini, (1957) 2016

Il designer traduce la morbidezza tipica di questo tipo di poltrona, ampia e profonda, dotata di schienale alto e poggiatesta laterali, in linee geometriche marcate e nette, con una scocca continua con braccioli ad ali appoggiata sull'essenziale struttura in legno. Gli elementi strutturali sono parte integrante dell'elegante estetica dell'arredo, come il dettaglio decorativo delle viti in legno, lasciate a vista per uno sguardo attento. Il modello ha caratterizzato molte delle più importanti composizioni di arredo d'interni di Frattini durante tutti gli anni '60. Rivestita in pelle, similpelle o tessuto, Giulia è disponibile in una vasta gamma di finiture e colori, per ambienti contemporanei dal gusto raffinato.



Giulia (Armchair),
base T43 Dark Walnut
W 86 D 95 H 104 cm
H seat 43 cm

Gio (Low Table),
top T67 Shiny Yellow,
base T43 Dark
Walnut → p.286



Giulia (Armchair),
base T49 Grey
W 86 D 95 H 104 cm
H seat 43 cm

Giulia (Ottoman),
base T49 Grey
W 57 D 51 H 42 cm

Gio (Low Table),
top T69 Shiny Grey,
base T49 Grey
→ p.286

→ Tacchini Edizioni: Linea (Rug)
designed by Maria Gabriella Zecca,
Nebula Interiors designed by
PearsonLloyd, fabric designed
by Lucia Pescador



Giulia (Armchair),
base T49 Grey
W 86 D 95 H 104 cm
H seat 43 cm

↳ Tacchini Edizioni: Linea
(Rug) designed by
Maria Gabriella Zecca

Giulia

Design Classic ↳ p.002
Discover Tacchini
process of re-editions

Relaunch of an original project of Gianfranco Frattini dated 1957, but still actual for its shapes and spirit, Giulia armchair creates in the contemporary space a timeless feeling of beauty, comfort and harmony. A flawless realization, typical of Tacchini's tradition, from the choice of materials for the embrace-shaped structure, to the ash wood basis dyed dark walnut or grey with artisan taste.



Gianfranco Frattini

Gianfranco Frattini was born in Padua, Italy, on 15th May, 1926. He graduated in Architecture, at the Politecnico, Milan, in 1953. At the end of the 50's, he is one of the founders of ADI, Association for Industrial Design. Frattini opened his own studio in Milan, after working in the office of his teacher and mentor Gio Ponti. In few years, he became an industrial designer, well-known worldwide. Among his many successful projects, in 1956 designed the chair model 849, nominated for the "Compasso d'Oro" Prize. Now, this armchair, which takes shapes from the original design, is proposed by Tacchini with the name of "Agnese".

Other products by Gianfranco Frattini:
Agnese ↳ p.038, Gio ↳ p.286, Lina ↳ p.032,
Oliver ↳ Vol. A p.050, Sesann (Sofa) ↳ Vol. A p.026,
Sesann (Armchair) ↳ p.050

En A re-edition of the famous Model 877 by Gianfranco Frattini, from 1957, named for the wife of Gio Ponti, the designer's great teacher and mentor. Giulia is Frattini's modern interpretation of the classic wing-back armchair and is one of the historic examples of Italian-made design. The designer uses clear, pronounced geometric lines to interpret the spacious and deep softness typical of this type of armchair with its high back and lateral headrests. The shell is all one piece with the wing-like armrests and sits on a sleek wood structure. The structural elements are an integral part of the elegant esthetic of the piece, as is the decorative detail of the wood screws, left exposed, to delight the attentive eye. The chair was featured in many of the leading interior decor projects by Frattini throughout the 1960s. Upholstered in leather, faux-leather or fabric, Giulia comes in a vast array of finishes and colors, suited to contemporary settings with a sophisticated vibe.

De Neuauflage des berühmten Modells 877 von Gianfranco Frattini aus dem Jahr 1957, das der Designer der Frau seinen großen Mentors Gio Ponti gewidmet hat. Mit Giulia hat Frattini eine moderne Interpretation des klassischen Ohrensessels und eines der historischen Modelle des Designs Made in Italy geliefert. Der Designer setzt die weichen Formen, die für diesen großen und tiefen Sessel mit hoher Rückenlehne und seitlichen Kopfstützen so typisch ist, mit markanten und klaren Linien und einer Sitzschale um, die in die Armlehnen und die charakteristischen Ohren übergeht und von einem schlichten Holzgestell gestützt wird. Die gestalterischen Elemente ergänzen die elegante Ästhetik des Sessels, wie zum Beispiel die Dekorationen auf den Holzschrauben in Sicht, die einem aufmerksamen Beobachter nicht entgehen. Frattini hat dieses Modell in den 60-er Jahren bei vielen seiner bedeutendsten Inneneinrichtungen eingesetzt. Giulia ist mit Bezug aus Leder, Kunstleder oder Stoff und in zahlreichen Oberflächen und Farben erhältlich und perfekt für ein modernes Ambiente mit geschmackvoller Eleganz.

Fr Une réédition du célèbre modèle 877 de Gianfranco Frattini, de 1957, dédié par le designer à l'épouse de Gio Ponti, son grand Maître. Interprétation moderne du classique fauteuil bergère par Frattini, Giulia fait partie des modèles historiques du design Made in Italy. Le designer a su traduire la douceur typique de ce type de fauteuil, large et profond, doté d'un dossier haut et d'oreilles, par des lignes géométriques marquées et nettes, et une coque continue avec des accoudoirs ailés qui repose sur un piètement minimaliste en bois. Les éléments structurels font partie intégrante de l'esthétique élégante du meuble, comme le détail décoratif des vis en bois, laissées visibles à un regard attentif. Le modèle a caractérisé bon nombre des plus importantes compositions d'ameublement d'intérieur de Frattini au cours des années 1960. Recouvert de cuir, de simili cuir ou de tissu, le fauteuil Giulia est disponible en une large gamme de finitions et de couleurs, pour des espaces raffinés de style contemporain.

Technical informations



Armchair, Ottoman ↳ p.330

Domestic, Contract

Sesann

Icona del design italiano degli anni '70, la collezione Sesann di Gianfranco Frattini appartiene a una nuova visione del vivere contemporaneo, nella quale l'ergonomia si adatta al cambiamento sociale, che vede instaurarsi un modo di sedersi meno rigido e composto. E oggi come allora invita alla bellezza del comfort più autentico.

Informazioni → p.053

Armchair, Sofa

Sesann è la rappresentazione assoluta della morbidezza. La progettualità geniale e inedita del design di Frattini crea sedute dalla forma sensuale e accogliente, generosamente armoniosa, caratterizzata da una struttura a vista in tubolare metallico cromato o verniciato, che avvolge, contiene e plasma l'imbottitura, con la quale si fonde come in un grande e morbido abbraccio senza soluzione di continuità. Il rivestimento, dal dettaglio estremamente ricercato, realizzato completamente a mano con rara eccellenza artigianale, rende ogni pezzo unico e mai uguale a un altro. Sesann viene proposto come poltrona e divano a tre o due posti, con un'ampia scelta di colori e finiture, dalla pelle al tessuto.

Designer, Year:
Gianfranco Frattini, (1970) 2015





Sesann (Armchair), structure
T28 Polished Black Chrome,
feet T43 Dark Walnut
W 110 D 94 H 67 H seat 38 cm

Sesann

Design Classic → p.002
Discover Tacchini
process of re-editions

Respecting the thought of Gianfranco Frattini, the new edition of Sesann keeps the spirit of the product intact. Characterized by a leather upholstery, Sesann owes its typical soft and enveloping form to the structure in pine plywood, covered with polyurethane foam and encircled with an architectural tubular steel (chromed or painted), with feet in ash wood. The particular configuration of Sesann – both formal and functional – constitutes the basis for a system of products characterized by the same structural elements, but declined in unique and fascinating objects. This approach of synthesis and reduction, proposed by Frattini, produced a formally elegant design, conceptually elaborated and, above all, unique.



Gianfranco Frattini

Gianfranco Frattini was born in Padua, Italy, on 15th May, 1926. He graduated in Architecture, at the Politecnico, Milan, in 1953. At the end of the 50's, he is one of the founders of ADI, Association for Industrial Design. Frattini opened his own studio in Milan, after working in the office of his teacher and mentor Gio Ponti. In few years, he became an industrial designer, well-known worldwide. Among his many successful projects, in 1956 designed the chair model 849, nominated for the "Compasso d'Oro" Prize. Now, this armchair, which takes shapes from the original design, is proposed by Tacchini with the name of "Agnese".

Other products by Gianfranco Frattini:
Agnese → p.038, Gio → p.286, Giulia → p.044,
Lina → p.032, Oliver → Vol. A p.050,
Sesann (Sofa) → Vol. A p.026

En An icon of Italian design in the 1970s, the Sesann collection by Gianfranco Frattini was part of a new vision of contemporary living in which ergonomics were adapted to social change, ushering in a way of sitting that is more relaxed and less stiffly formal. Today, as then, it is an open invitation to the beauty of comfort in its most authentic expression. Sesann is the absolute epitome of softness. Frattini's gifted design concept produces seating elements with sensual, generously harmonious, inviting shapes. It features an exposed, wrap-around chrome or powder-coated tubular metal structure that contains and sculpts the upholstery, becoming one with it in a huge, soft, seamless embrace. The upholstery, embellished with extremely sophisticated detailing, is completely handcrafted with extraordinary artisan skill, making it a one-of-a-kind masterpiece. Sesann is available as an armchair and a sofa three and two seaters, in a broad array of colors and finishes, from leather to fabric.

De Die Kollektion Sesann von Gianfranco Frattini ist eine Ikone des italienischen Designs der 70-er Jahre und Teil einer neuen Vision des modernen Lebens, bei der sich die Ergonomie an die gesellschaftlichen Veränderungen anpasst und der Trend zu einem weniger steifen und anständigen Sitzen geht. Und auch heute noch ist Sesann die Aufforderung, die Schönheit des authentischen Komforts zu erleben. Sesann ist das Sinnbild für Weiche. Die geniale Gestaltung und das innovative Design von Frattini schaffen Sitzmöbel mit sinnlicher und behaglicher Form, die auf harmonische Weise großzügig sind und über ein charakteristisches Gestell in Sicht aus verchromtem oder lackiertem Metallprofil verfügen, das die Polsterung umgibt, umschließt und formt und sich mit ihr in einer großen und warmen Umarmung übergangslos verbindet. Der Bezug mit extrem hochwertigen Details wird komplett und mit herausragender, handwerklicher Fertigkeit von Hand ausgeführt und macht jedes Stück zu einem Einzelstück, sodass kein Sofa oder Sessel dem anderen gleicht. Sesann ist in der Version als Sessel und als Zweisitzer- und Dreisitzersofa erhältlich, mit einer breiten Palette an Farben und Oberflächen aus Leder und Stoff.

Fr Icône du design italien des années 1970, la collection Sesann de Gianfranco Frattini appartient à une nouvelle vision de la vie contemporaine, dans laquelle l'ergonomie s'adapte au changement social qui voit l'instauration d'une manière de s'asseoir moins rigide et moins sage. Et aujourd'hui comme à l'époque, elle invite à la beauté du confort authentique. Sesann est la représentation absolue du moelleux. L'inventivité géniale et originale du design de Frattini donne le jour à des sièges de forme sensuelle et accueillante, généreusement harmonieuse, se démarquant par une structure apparente en tube métallique chromé ou peint, qui enveloppe, contient et façonne le rembourrage avec lequel elle fusionne comme en une étreinte forte et douce sans solution de continuité. Entièrement réalisé à la main avec une rare excellence artisanale, le revêtement, doté de détails extrêmement recherchés, fait que chaque pièce n'est jamais égale à aucune autre. Sesann est disponible en fauteuil et en canapé deux ou trois places, en un large choix de couleurs et de finitions, du cuir au tissu.

Technical informations



Armchair → p.336



Sofa → p.336

Lagoa

Zanini de Zanine, celebre designer brasiliano, figlio dell'architetto e designer José Zanine Caldas, disegna un modello assolutamente inedito, progettato in esclusiva per Tacchini, Lagoa.

Informazioni → p.059



Una poltrona dal volume morbido e tondeggiante che accoglie una seduta sospesa dal forte contrasto nello spessore. Gli estremi del sedile si inseriscono nei fianchi della struttura infilandosi a scomparsa in un abbraccio naturale senza soluzione di continuità. Un pezzo dalla creatività brillante, inedita, che trae ispirazione dalla morbidezza della tradizione carioca, con uno spirito visionario completamente nuovo.

Designer, Year:
Zanini De Zanine, 2019

Awards: 2019 Good Design Award



Lagoa (Armchair)
W 90 D 74 H 78 cm
H seat 33 cm

Joaquim (Low Table), base T27
Matt Black Chrome, top T119 Elegant
Brown Marble ↗ p.282

Lagoa



Lagoa (Armchair)
W 90 D 74 H 78 cm
H seat 33 cm

Lagoa

En Zanini de Zanine, the famous Brazilian designer, son of architect and designer José Zanine Caldas, creates an absolutely original model, conceived exclusively for Tacchini: Lagoa. Its soft, rounded forms surround a suspended seat that gives a marked contrast in terms of thickness. The ends of the seat slot into the sides of the structure, disappearing into a seamless natural embrace. A piece that shows brilliant, original creativity, drawing inspiration from the softness of the Carioca tradition, with an all-new visionary spirit.

De Zanini de Zanine, der berühmte brasilianische Designer, Sohn des Architekten und Designers José Zanine Caldas, entwirft exklusiv für Tacchini ein absolut einzigartiges Modell, Lagoa. Ein Sessel mit einem weichen, halbrunden Volumen, das eine schwebende Sitzfläche hält, deren geringe Dicke in starkem Kontrast zu der breiten Rundung der Struktur steht. Der Rand des Sitzes verschwindet in den Seiten der halbrunden Struktur, die den Sitz ganz einfach, in kontinuierlicher Linie umarmt. Ein Design von brillanter, einzigartiger Kreativität, die sich an der weichen Schmiegsamkeit der brasilianischen Tradition inspiriert, und zwar mit einem völlig neuen, visionären Geist.

Fr Le célèbre designer brésilien et fils de l'architecte et designer José Zanine Caldas, Zanini de Zanine, a conçu Lagoa, un modèle absolument nouveau, en exclusivité pour Tacchini. Ce fauteuil au volume doux et arrondi accueille une assise suspendue d'une épaisseur fortement contrastée. Les extrémités du siège sont insérées dans les flancs de la structure, disparaissant dans une étreinte naturelle sans solution de continuité. Cette pièce d'une créativité brillante et inédite puise son inspiration dans la douceur de la tradition carioca, avec un esprit visionnaire entièrement nouveau.



Zanini De Zanine

Born in Rio de Janeiro in 1978, Zanini de Zanine grew up watching his father, José Zanine Caldas work. He trained with Sergio Rodrigues, when he produced his first mobile. In 2002 he graduated in Industrial Design at PUC-Rio. From 2003, he began producing solid wood furniture, with pieces of demolition – columns, beams and posts of old houses – baptized as "Contemporary Carpentry." From 2005, he began to create a new line of furniture pieces produced industrially using controlled origin wood and different materials such as plastic, acrylic, metals and other parts of manufactured products. To represent this new furniture line, Zanini creates in 2011 Studio Zanini.

Technical informations



Armchair → p.333

Domestic, Contract

Armchair, Ottoman, Low Table

Pastilles

Il nuovo progetto Tacchini con Studiopepe è una collaborazione con le designer Arianna Lelli Mami e Chiara Di Pinto – le menti creative dietro il noto studio di interior e product design.

Informazioni → p.065

Pastilles è una collezione di poltroncine, pouf e tavolini, dalle forme morbide e avvolgenti che rimandano a ricordi d'infanzia. Una rivisitazione contemporanea della classica poltrona a pozzetto, con una sinuosa conchiglia che contiene la seduta e che dona comfort al design. Completati da due tavoli di diverse dimensioni e un pouf, questi elementi creano una famiglia di forme coerenti che può essere utilizzata come sistema o come singolo oggetto.

Designer, Year:
Studiopepe, 2018



Pastilles

Pastilles (Armchair), base
Matt Champagne Gold
W 57 D 55 H 73 cm
H seat 47 cm

Pastilles (Ottoman), base
Matt Champagne Gold
W 57 D 55 H 47 cm

Pastilles (Low Table),
top T29 Shiny White
Carrara Marble, base Matt
Champagne Gold
Ø 100 H 33 cm

Reversível (Armchair)
→ p.018



Pastilles (Armchair),
base Aluminium
W 57 D 55 H 73 H seat 47 cm

Pastilles (Ottoman),
base Aluminium
W 57 D 55 H 47 cm



Pastilles

Pastilles (Low Table),
base Aluminium
Ø 100 H 33 cm

↳ Tacchini Edizioni:
E63 (Lamp) designed
by Umberto Riva



Pastilles (Armchair), base
Matt Champagne Gold
W 57 D 55 H 73 H seat 47 cm

Pastilles (Low Table), top T29
Shiny White Carrara Marble,
base Matt Champagne Gold
Ø 50 H 43 cm

Pastilles

En The new project with Studiopepe is a collaboration with designers Arianna Lelli Mami and Chiara Di Pinto, the creative minds behind the consultancy. Pastilles is a collection of small armchairs, ottomans and coffee tables, with soft and enveloping shapes that bring back childhood memories, the sweets. A contemporary reinterpretation of the classic cockpit armchair, with a sinuous shell that contains the seat and that gives excellent comfort to the design. Completed by two tables of different sizes and an ottoman, these elements create a matched family of shapes that can be used as a system or as single objects.

De Das neue Projekt von Tacchini mit Studiopepe beruht auf einer Zusammenarbeit mit den Designern Arianna Lelli Mami und Chiara Di Pinto – deren Kreativität die Seele des renommierten Studios für Interior und Product Design ist. Pastilles ist eine Kollektion von kleinen Sesseln, Poufs und Beistelltischen mit weichen gerundeten Formen, die Kindheits-erinnerungen aufrufen. Eine moderne Neuausgabe des klassischen Cockpit-Sessels, mit einer halbrunden Schale, die den Sitz umgibt und dem Design Komfort bietet. Begleitet von zwei Tischen in verschiedenen Größen und einem Pouf, entsteht eine Familie von auf einander abgestimmten Formen, die als Ensemble oder aber als Einzelobjekt benutzt werden kann.

Fr Le nouveau projet « Tacchini con Studiopepe » est une collaboration avec les designers Arianna Lelli Mami et Chiara Di Pinto – les deux créatrices qui animent le célèbre studio de design d'intérieur et de produit. Pastilles est une collection de fauteuils, poufs et tables basses aux formes douces et enveloppantes qui renvoient à des souvenirs d'enfance. Une réinterprétation contemporaine du fauteuil baquet classique, avec une coque sinueuse qui contient l'assise et donne du confort au design. Complétés par deux tables de dimensions différentes et un pouf, ces éléments créent une famille de formes cohérentes qui peut être utilisée comme système ou comme élément autonome.



Studiopepe

Internationally recognized for its eclectic and multi-faceted approach, Studiopepe adopts an imaginative and multidisciplinary approach towards the world of design. The studio's distinctive signature is eloquently expressed in all the heterogeneous projects in which it has been engaged: large-scale projects in the hôtellerie field, the creation of displays for showrooms, boutiques and fair booths, or the interior design of private homes. Founded in 2006, the agency has maintained a highly recognizable identity based upon experimenting, citations and unexpected thought associations which are aimed at fostering unique projects that respect the individuality of the Client. Studiopepe's projects are characterized by a strong emotional and aesthetic impact, based upon the finding the ideal balance between formal rigour and poetic vision, the ceaseless search to blend contemporary languages and codes. In the Studio's works, the unexpected becomes a constant: the bold interplay between materials, fields of colour that become the expression of space, and details that are no longer mere decoration, but delicately woven storytelling.

Technical informations



Armchair → p.335



Ottoman → p.335



Low Table → p.335

Shelter

Una scultura ispirata alla purezza della natura, un luogo a sé, dove ritrovarsi nel momento e nello spazio. La poltrona Shelter, design Noé Duchaufour-Lawrance, invita alla sosta per restituire al corpo equilibrio ed energia, nell'istante che mette comfort e riflessione al primo posto.

Informazioni → p.071



Moderna interpretazione della poltrona da relax e lettura, Shelter accoglie in una seduta dal tempo lento, che caratterizza lo spazio con la leggerezza di una linea nuova senza tempo. Lo schienale alto con poggiatesta laterali e cuscino centrale completa l'elegante ergonomia dell'arredo, perfetto per un angolo privato dello spazio domestico o per le sale d'attesa o le zone relax di studi professionali, spazi pubblici e contract. La base metallica si accosta alla finitura in pelle o tessuto della seduta. Accompagna il comfort del modello il pouf abbinato.

Designer, Year:
Noé Duchaufour-Lawrance, 2014

Shelter

067

Shelter (Armchair),
base T27 Matt Black Chrome
W 69,5 D 85 H 114,5 cm
H seat 41 cm

Shelter (Ottoman),
base T27 Matt Black Chrome
W 60 D 51 H 41 cm

066



Shelter



Shelter (Armchair),
base T27 Matt Black Chrome
W 69,5 D 85 H 114,5 cm
H seat 41 cm

En Inspired by the purity of nature, it is a sculpture, a place unto itself, where self-reflection comes naturally. Shelter armchair, designed by Noé Duchaufour-Lawrance, is a welcome pause, a place to restore balance and energy to the body, in the moment where comfort and reflection prevail. A modern interpretation of the ideal chair for relaxation and reading, Shelter envelops, slowing time, transporting lightness and new, timeless lines to the space it inhabits. The backrest, with lateral headrests and center head cushion, completes the ergonomic luxury of the chair, perfect for a private niche at home, in waiting rooms or relaxation rooms in professional offices, public spaces and contract settings. The metal base is coordinated with the armchair's leather or fabric upholstery. Complementary comfort provided by the matching footstool.

De Eine Skulptur, die sich an der Reinheit der Natur inspiriert, ein eigenständiger Ort innerhalb von Raum und Zeit. Der Sessel Shelter des Designers Noé Duchaufour-Lawrance lädt zu einer Rast ein, um den Körper wieder ins Gleichgewicht zu bringen und Energie zu tanken, in einem Moment der Ruhe, in dem Komfort und Besinnung oberste Priorität haben. Shelter ist eine moderne Interpretation des Entspannungs- und Lesesessels und bietet einen Sitzkomfort fern von Hektik und Stress und ein Design, das dem Raum mit einer neuen und zeitlosen Linie Charakter verleiht. Die hohe Rückenlehne mit seitlichen Kopfstützen und Nackenkissen vervollständigt die elegante Ergonomie des Sessels, der perfekt ist für Wartebereiche oder Entspannungsbereiche in Büros und Studios, für öffentliche Bereiche und für Objekteinrichtungen. Das Metallgestell harmonisiert mit dem Stoff- oder Lederbezug der Sitzfläche. Für besonderen Komfort garantiert der passende Polsterhocker.

Fr Une sculpture inspirée par la pureté de la nature, un lieu en soi, où l'on se retrouve dans l'instant et dans l'espace. Dessiné par Noé Duchaufour-Lawrance, le fauteuil Shelter invite à s'octroyer une pause pour que le corps retrouve équilibre et énergie, au moment où le confort et la réflexion sont au premier plan. Shelter est une interprétation moderne du fauteuil de relaxation et de lecture ; son assise accueillante, sous le signe de la lenteur, caractérise l'espace avec la légèreté d'une ligne nouvelle, intemporelle. Le dossier haut avec des oreilles et un coussin central vient compléter l'ergonomie élégante de ce modèle parfait pour un coin intime de l'espace domestique ou pour les salles d'attente ou les zones de détente de cabinets professionnels, d'espaces publics et contract. Le piètement en métal se marie à la finition en cuir ou en tissu de l'assise. Le pouf assorti apporte un supplément de confort.



Noé Duchaufour-Lawrance

Designer and interior architect, Noé Duchaufour-Lawrance has defined his own language using natural shapes which are supple, organic, fluid and structured at the same time. A double passion for the material and for the shape embodied by a double faceted course of studies: first of all following a course in Sculpture on Metal (at the Ecole Nationale Supérieure des Arts Appliqués et des Métiers d'Art), then design at the Arts Décoratifs in Paris. In response to a creative family environment (his father was a sculptor), Noé Duchaufour-Lawrance very quickly displayed an unusual aesthetic quality, which stands out, beginning with the restaurant Sketch in Soho in 2002. He established his own design studio the following year and has henceforth seized each project as a real opportunity to define an aesthetic quality of his own, to design harmonious objects and areas with an aim to establish an emotional bond with nature.

Technical informations



Armchair, Ottoman ⇨ p.337

Domestic, Contract

Kelly

Linea e colore. Minimalismo che celebra contrasti netti e pieni. Ispirata alla visione artistica di Ellsworth Kelly, una collezione di sedute pluripremiata, dal design irresistibilmente brillante, che comprende sedie, poltrone e poltrona lounge con pouf coordinato.

Informazioni → p.081



Armchair, Ottoman, Chaise-longue, Stool,
Chair, Table, Low Table

Kelly, design Claesson Koivisto Rune, celebra la creatività, dando grande possibilità di personalizzazione nella combinazione degli elementi, con l'accostamento di modelli diversi, declinazioni di un arredo unico dalle innumerevoli destinazioni. Caratterizzata da una sottile struttura metallica che accoglie con leggerezza quasi sospesa seduta e schienale imbottiti dai diversi volumi, la collezione presenta differenti proporzioni di schienali e scocche, che rendono infinitamente divertente la molteplice possibilità compositiva, con accostamenti di finiture e cromie diverse, per un ambiente dal design contemporaneo alla moda e funzionale allo stesso tempo.

Awards: 2013 Red Dot Design Award, 2013 Elle Decoration International Design Award, 2013 Good Design Award

Designer, Year:
Claesson Koivisto Rune, 2013



Kelly E (Armchair),
base T18 Green
W 70 D 80 H 81 cm
H seat 39,6 cm





Kelly E (Armchair),
base T04 Grey
W 70 D 80 H 81 cm
H seat 39,6 cm

Kelly H (Armchair),
base T04 Grey
W 104 D 78 H 126 cm
H seat 43 cm





Kelly S (Stool),
base T07 Black
W 44 D 36 H 41 cm

Kelly

En Contours and color. A minimalist celebration of clear, rounded contrasts. Taking inspiration from the artistic vision of Ellsworth Kelly, this is a multi-award-winning collection of seating elements. The irresistibly smart design comes in a collection of chairs, armchairs and a chaise longue with matching ottoman. Designed by Claesson Koivisto Rune, Kelly celebrates creativity, offering every possibility for customization in the combination of different pieces, expressions of a singular décor statement with countless destinations. With airy visual lightness, the slender metal structure welcomes the different-shaped upholstered seats and backrests. The collection offers backrests and shells in various proportions, which also lends limitless fun to discovering the many arrangements possible. Combine different finishes and colors for a fashionably contemporary and functional decor.

De Linie und Farbe. Minimalismus, der klare und deutliche Kontraste feiert. Eine mehrfach ausgezeichnete Kollektion mit Stühlen, Sesseln, Lounge-sesseln und passenden Polsterhockern, die sich an der künstlerischen Vision von Ellsworth Kelly inspiriert und durch ihr absolut unwiderstehliches und brillantes Design auszeichnet. Die Kollektion Kelly der Designer Claesson Koivisto Rune feiert die Kreativität und bietet viele Personalisierungsmöglichkeiten bei der Kombination der Elemente, auch unter Verwendung verschiedener Modelle, um eine einzigartige Einrichtung für zahlreiche Anwendungsbereiche zu schaffen. Die Sitzmöbel zeichnen sich durch ihr zierliches Metallgestell aus, das mit einer fast schwebenden Leichtigkeit die gepolsterte Sitzfläche und Rückenlehne in unterschiedlichen Formen und Größen hält. Die Proportionen von Rückenlehnen und Sitzschalen variieren innerhalb der Kollektion und bieten die Möglichkeit, verschiedene Oberflächen und Farben zu kombinieren, für ein Ambiente mit zeitgenössischem Design, das gleichzeitig modern und funktionell ist.

Fr Ligne et couleur. Un minimalisme qui célèbre des contrastes nets et pleins. Inspiré de la vision artistique d'Ellsworth Kelly, cette collection de sièges multirécompensée et au design irrésistiblement brillant comprend des chaises, des fauteuils et un fauteuil lounge avec pouf assorti. Kelly, conçue par Claesson Koivisto Rune, célèbre la créativité en offrant de grandes possibilités de personnalisation dans la combinaison des éléments, d'association avec des modèles divers, déclinaisons d'un meuble unique aux innombrables destinations. Caractérisée par une fine structure métallique qui accueille l'assise et le dossier rembourrés de volumes divers avec une légèreté presque aérienne, la collection arbore différentes proportions de dossiers et de coques, ce qui rend les multiples possibilités de composition infiniment amusantes, avec différentes combinaisons de finitions et de couleurs, pour un espace design de style contemporain à la fois fonctionnel et à la mode.



Claesson Koivisto Rune

The Claesson Koivisto Rune studio was established in 1995 as a multidisciplinary architecture and design workshop, in line with the classic Scandinavian tradition, but with the aim of exploring new concepts, and pursuing the values of simplicity and innovation. The three Swedes have created architectural designs throughout the world and in every sector, from homes to restaurants, retail to executive buildings, as well as furniture ranges for numerous major international firms.

Other products by Claesson Koivisto Rune: Campo (Tacchini Edizioni), Doodle (Armchair, Chaise-longue) → p.082, Doodle (Chair, Stool) → p.228, Isola → p.114, Kelly B → p.296, Kelly C → p.202, Kelly C Basic → p.202, Kelly O → p.296, Kelly T → p.266, Kelly V → p.210, Kelly W → p.296, Lima → Vol. A p.078, Misura S/M → p.150, Montevideo (Sofa, Armchair, Ottoman) → Vol. A p.056, Montevideo (Chair) → p.222, Pisa → p.100, Quartier → p.176, Santiago → Vol. A p.070, Spin → p.182, Split → p.260

Technical informations



Armchair (Kelly E/H/L+F) → p.332



Low Table (Kelly B/O/W) → p.351

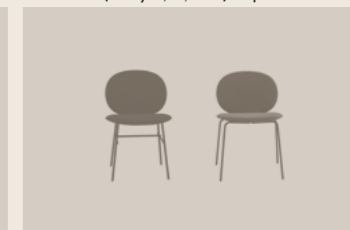

Chair (Kelly C/C Basic/S/P) → p.342



Table (Kelly T) → p.345



Chair (Kelly V) → p.343

Domestic, Contract

Armchair, Chaise-longue, Chair, Stool

Doodle

In inglese la parola *doodle* significa scarabocchio e descrive i disegni che si fanno mentre la mente è concentrata su qualcos'altro.

Informazioni → p.088

Designer, Year:
Claesson Koivisto Rune, 2008

Queste linee tracciate quasi per caso sono diventate la cifra stilistica dell'omonima poltrona, caratterizzata da una cucitura a vista tono su tono o a contrasto con la tinta del rivestimento. Doodle è pensata sia per gli spazi domestici sia per quelli del contract, anche in abbinamento a sedie e sgabelli della stessa serie.



Doodle

Doodle (Chaise-longue),
base T25 Matt Champagne Gold
W 87 D 78 H 77 H seat 41 cm





Doodle (Armchair),
base T07 Black
W 62 D 59 H 85 cm
H seat 46 cm



Doodle (Armchair),
base T07 Black
W 62 D 59 H 85 cm
H seat 46 cm



Doodle (Chaise-longue),
base T02 White
W 87 D 78 H 77 cm
H seat 41 cm

Doodle

En Doodle – the absent-minded scribbles we draw while thinking about other things. These almost-random lines have become the key stylistic feature of these chairs of the same name, with their visible tone-one-tone or contrasting stitching. Doodle is designed for both domestic and contract use, and combines beautifully with the reception chairs and stools from the same series.

De Doodle ist ein englischer Ausdruck für Kritzelei und beschreibt Zeichnungen, die man unwillkürlich ausführt, wenn man sich auf etwas anderes konzentriert. Diese wie zufällig hingeworfenen Linien wurden zum stilistischen Merkmal des gleichnamigen Sessels, mit der charakteristischen Naht auf Sicht in der gleichen Farbe wie der Bezug oder von diesem farblich abgesetzt. Doodle eignet sich für den häuslichen Raum ebenso wie für Objekteinrichtungen, auch in Verbindung mit den Stühlen und Hockern der gleichen Serie.

Fr En anglais, le mot Doodle signifie gribouillage et décrit les dessins que l'on fait quand l'esprit est concentré sur quelque chose d'autre. Ces lignes tracées presque par hasard sont devenues le trait stylistique du fauteuil du même nom, caractérisé par une couture apparente ton sur ton ou en contraste sur la couleur du revêtement. Doodle est pensé aussi bien pour les espaces domestiques que pour les espaces collectifs, associé éventuellement aux chaises et aux tabourets de la même série.



Claesson Koivisto Rune

The Claesson Koivisto Rune studio was established in 1995 as a multidisciplinary architecture and design workshop, in line with the classic Scandinavian tradition, but with the aim of exploring new concepts, and pursuing the values of simplicity and innovation. The three Swedes have created architectural designs throughout the world and in every sector, from homes to restaurants, retail to executive buildings, as well as furniture ranges for numerous major international firms.

Other products by Claesson Koivisto Rune:
Campo (Tacchini Edizioni), Doodle (Chair, Stool) → p.228,
Isola → p.114, Kelly B → p.296, Kelly C → p.202,
Kelly C Basic → p.202, Kelly E → p.072, Kelly H → p.072,
Kelly L+F → p.072, Kelly O → p.296, Kelly S → p.072,
Kelly T → p.266, Kelly V → p.210, Kelly W → p.296,
Lima → Vol. A p.078, Misura S/M → p.150, Montevideo
(Sofa, Armchair, Ottoman) → Vol. A p.056, Montevideo
(Chair) → p.222, Pisa → p.100, Quartier → p.176,
Santiago → Vol. A p.070, Spin → p.182, Split → p.260

Technical informations

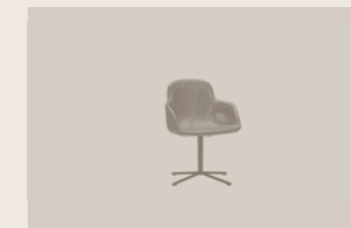

Armchair → p.340



Chaise-longue → p.340

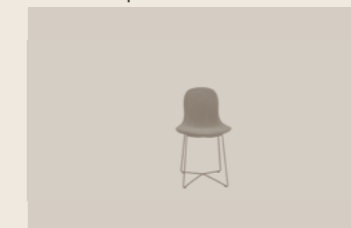

Chair → p.340



Stool → p.340

Dot

La poltrona Dot raccoglie i valori simbolici della casa ideale, traducendoli in morbide curve, geometrie avvolgenti, sensazioni tattili e linee essenziali.

Informazioni → p.093



Designer, Year:
Patrick Norguet, 2015

Il suo progetto è caratterizzato da una forma unica e continua, con lo schienale curvato che si trasforma delicatamente in un elemento strutturale, mentre l'imbottitura conferisce stabilità e comfort alla seduta, sollevata da una base dalla forma contrastante, disponibile sia in legno che in metallo.



Dot

Dot (Armchair),
base T02 White
W 87 D 81 H 92 cm
H seat 42 cm

Split (Low Table),
top T57 White,
base T02 White
→ p.260



Dot (Armchair),
base T02 White
W 87 D 81 H 92 cm
H seat 42 cm

Dot

En Dot armchair embraces the symbolic values of the ideal home and turns them into soft curves, embracing geometries, tactile feelings and simple lines. Its project is characterized by a unique and continuous shape, with a curved backrest which gently becomes a structural element, while the padding gives stability and comfort to the seat, raised by a contrasting basement shape, available in wood and metal.

De Der Sessel Dot nimmt die symbolischen Werte des idealen Heims auf und übersetzt sie in weiche Kurven, umhüllende Geometrien, angenehme Haptik und einfache Linien. Er ist durch eine eigene und fließende Form charakterisiert. Die gekrümmte Rückenlehne wird zum Strukturelement, während die Polsterung Stabilität und Komfort gibt. Das alles sitzt auf einer kontrastierenden Basis, die in Holz oder Metall lieferbar ist.

Fr Le fauteuil Dot accueille les valeurs symboliques de la maison idéale et les traduit avec des courbes douces, des géométries envoûtantes, des sensations tactiles et des lignes essentielles. Son projet est caractérisé par une forme unique et continue, avec un dossier courbé qui se transforme délicatement en un élément structural tandis que le rembourrage donne stabilité et confort à l'assise qui est relevé par une base à la forme contrastante, disponible en bois et en métal.



Patrick Norguet

Patrick Norguet is a key figure in French design today, and was elected "furniture designer of the year" by Wallpaper magazine in 2009. He began his career as a project designer in the late nineties, working with numerous big names in the furniture design world, in addition to completing a number of interior and set design projects. He has always sought to select the right shapes and colours, exuding a love of innovative industrial processes, artisanal ateliers and the people working there.

Other products by Patrick Norguet:
Atoll ↪ p.186, Jacket ↪ p.094

Technical informations

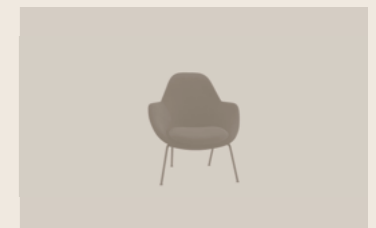

Armchair ↪ p.330

Domestic, Contract

Armchair

Jacket

Visibilmente ispirata al mondo della moda, la poltrona Jacket si presenta in una versione rinnovata nella realizzazione sartoriale e nelle tonalità della struttura metallica, dalle linee snelle e sinuose.

Informazioni → p.099

Designer, Year:
Patrick Norguet, 2012

Il tessuto trapuntato non si limita a vestirla, ma diventa esso stesso una morbida ed accogliente scocca, con un bordo che ricorda il bavero di una giacca. Due cuscini aggiungono una soffice sensazione di comfort.

Awards: 2013 Wallpaper Design Awards

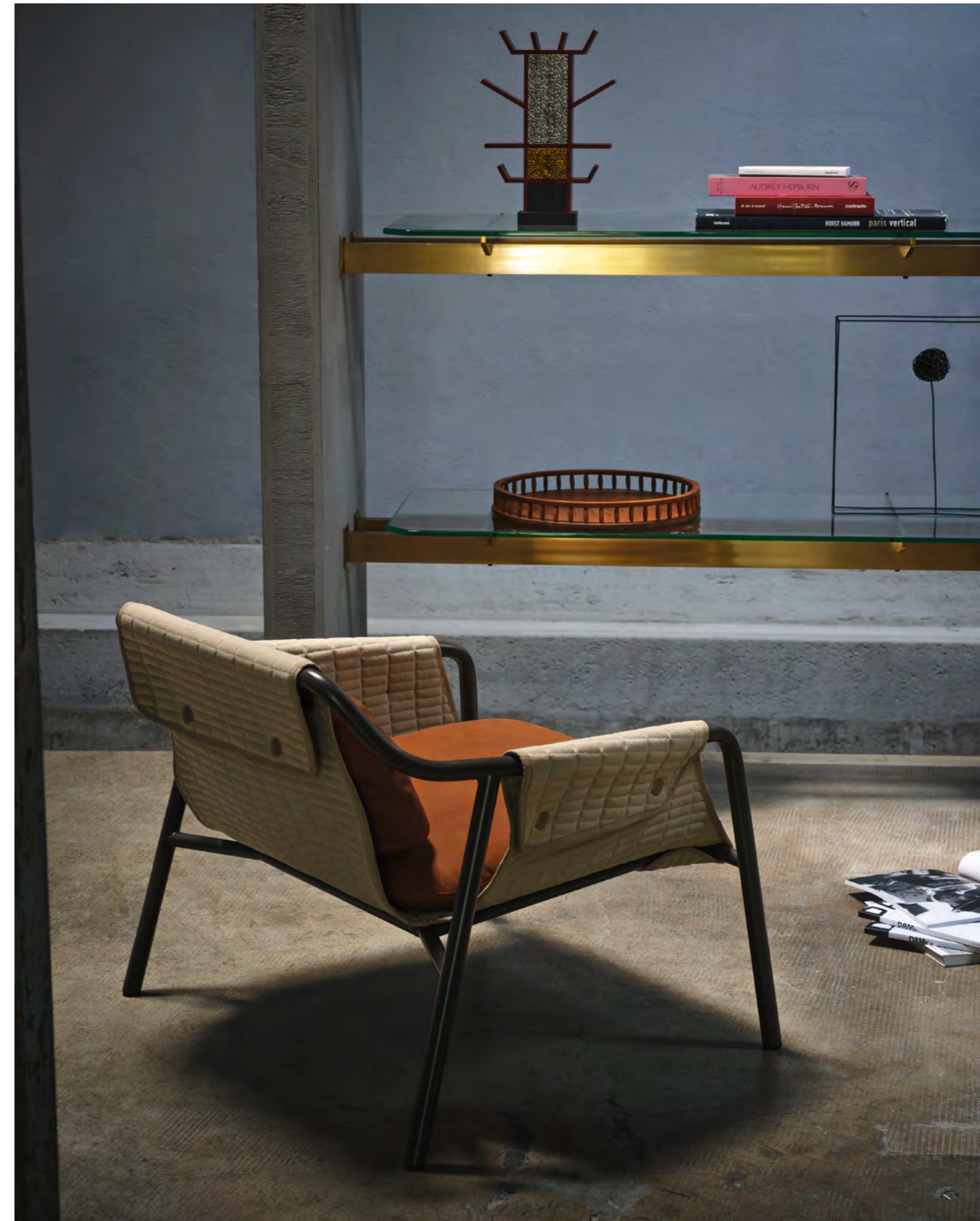

Jacket

Jacket (Armchair),
base T04 Grey
W 89 D 80 H 79 cm
H seat 42 cm





Jacket (Armchair),
base T04 Grey
W 89 D 80 H 79 cm
H seat 42 cm

Jacket

En Drawing evident inspiration from the fashion world, Jacket armchair now appears in a renewed version, with revamped sartorial details and new colours for its sleek and slender metal frame. The quilted fabric, in addition to dressing the piece, forms its soft, cosy shell, with edging reminiscent of a jacket lapel. Two cushions add a sense of snug comfort.

De Der Sessel Jacket, der sichtbar von der Welt der Mode beeinflusst ist, präsentiert sich in einer erneuerten, maßgeschneiderten Ausführung und in neuen Farben für das metallische Untergestell in schlanken, geschwungenen Linien. Der gesteppte Bezug ist nicht nur eine Bekleidung, sondern wird selbst zu einer weichen, behaglichen Sitzschale, mit einem oberen Abschluss, der an einen Rockkragen erinnert. Verstärkt wird der flauschige Komfort durch zwei Kissen.

Fr S'inspirant clairement du monde de la mode, le fauteuil Jacket se présente dans une version renouvelée dans la fabrication très « couture » et dans les teintes de la structure métallique, aux lignes fines et sinueuses. Le tissu matelassé ne se limite pas à l'habiller mais devient lui-même une coque douce et accueillante, avec un bord qui rappelle le revers d'une veste. Deux coussins ajoutent une sensation de confort douillet.



Patrick Norguet

Patrick Norguet is a key figure in French design today, and was elected "furniture designer of the year" by Wallpaper magazine in 2009. He began his career as a project designer in the late nineties, working with numerous big names in the furniture design world, in addition to completing a number of interior and set design projects. He has always sought to select the right shapes and colours, exuding a love of innovative industrial processes, artisanal ateliers and the people working there.

Other products by Patrick Norguet:
Atoll ↪ p.186, Dot ↪ p.090

Technical informations



Armchair ↪ p.332

Pisa

A partire dalla forma visiva del linguaggio verbale – presa a prestito dalla semplice configurazione della lettera ‘u’ – i designer svedesi traducono il gioco di estrusioni tridimensionali riferendosi al silenzioso linguaggio del corpo umano.

Informazioni → p.107



Disegnata principalmente per spazi pubblici, uffici o alberghi, Pisa è una poltrona imbottita di dimensioni compatte, adatta ad ambienti ristretti, senza tralasciare il comfort e l'estetica. Le sue forme minimali avvolgono il corpo, creando una sensazione intima e personale. Il suo disegno geometrico, con schienale inclinato e caratteristico profilo tagliato, crea una forte personalità nonostante le misure contenute.

Awards: 2016 German Design Awards

Designer, Year:
Claesson Koivisto Rune, 2015







Pisa (Armchair)
W 67 D 76 H 82 cm
H seat 45 cm

Pisa

En From the visual form of the verbal language – borrowed from the simple configuration of the letter “u” – the Swedish designers translate the game of three-dimensional extrusion, starting from the silent language of human body. Essentially designed for public spaces, offices or hotels, Pisa is an upholstered armchair with compact dimensions, suitable for tight spaces but without excluding aesthetic and comfort. Its minimal shapes embrace the body, creating an intimate feeling. Its geometric shape, with the sloping backrest and a cut profile, creates a strong personality despite restrained measures.

De Ausgehend von der visuellen Form der verbalen Sprache und in Anlehnung an die einfache Konfiguration des Buchstabens „u“ spielen die schwedischen Designer mit dreidimensionalen Formen und greifen dabei die stumme Körpersprache auf. Vor allem für den öffentlichen Raum, Büros oder Hotels entwickelt, ist Pisa ein gepolsterter Sessel mit kompakten Dimensionen für kleine Räume, ohne Komfort und Ästhetik zu verlieren. Seine minimalistischen Formen hüllen den Körper ein und schaffen ein intimes und persönliches Gefühl. Seine geometrische Gestaltung mit geneigter Rückenlehne und dem besonders geschnittenen Profil schafft eine starke Persönlichkeit mit kleinen Maßen.

Fr La forme visuelle du langage verbal – empruntée à la configuration simple de la lettre « u » – est le point de départ des designers suédois qui traduisent le jeu d’extrusions tridimensionnelles en se référant au langage silencieux du corps humain. Dessiné principalement pour les espaces publics, bureaux et hôtels, Pisa est un fauteuil rembourré aux dimensions compactes, adapté pour les espaces étroits, sans négliger le confort et l’esthétique. Ses formes minimales enveloppent le corps et créent une sensation intime et personnelle. Son dessin géométrique, avec dossier incliné et son profil coupé caractéristique, donne une forte personnalité malgré la taille compacte.



Claesson Koivisto Rune

The Claesson Koivisto Rune studio was established in 1995 as a multidisciplinary architecture and design workshop, in line with the classic Scandinavian tradition, but with the aim of exploring new concepts, and pursuing the values of simplicity and innovation. The three Swedes have created architectural designs throughout the world and in every sector, from homes to restaurants, retail to executive buildings, as well as furniture ranges for numerous major international firms.

Other products by Claesson Koivisto Rune:
Campo (Tacchini Edizioni), Doodle (Armchair, Chaise-longue) → p.082, Doodle (Chair, Stool) → p.228, Isola → p.114, Kelly B → p.296, Kelly C → p.202, Kelly C Basic → p.202, Kelly E → p.072, Kelly H → p.072, Kelly L+F → p.072, Kelly O → p.296, Kelly S → p.072, Kelly T → p.266, Kelly V → p.210, Kelly W → p.296, Lima → Vol. A p.078, Misura S/M → p.150, Montevideo (Sofa, Armchair, Ottoman) → Vol. A p.056, Montevideo (Chair) → p.222, Quartier → p.176, Santiago → Vol. A p.070, Spin → p.182, Split → p.260

Technical informations



Armchair → p.335

Contract

Armchair, Sofa

Crystal

Angoli obliqui che ricordano le forme di antichi obelischi, creando un architettonico gioco di luci e di ombre.

Informazioni → p.113

Designer, Year:
PearsonLloyd, 2011

Volumi pieni che sembrano magicamente galleggiare sul pavimento, su una base nascosta alla vista. Crystal è una famiglia di divani e poltrone, che si distacca dagli standard e dai luoghi comuni, generando un senso di sospensione e di dinamismo, senza utilizzare inutili artifici estetici, ma puntando su una sapiente, quanto assoluta, semplicità.



Crystal

Crystal (Armchair)
W 96 D 80 H 68 cm
H seat 43 cm





Crystal

En Oblique corners reminding of ancient obelisk shapes, creating an architectural play of light and shadow. Full volumes seem to float above the floor, on a hidden base. Crystal is a collection of sofas and armchairs away from ordinary standards and clichés which gives birth to a suspended and dynamic effect with no need of aesthetic devices. It's just about smart and absolute simplicity.

De Schräge Ecken erinnern an antike Obelisken und schaffen ein architektonisches Spiel von Licht und Schatten. Volle Volumen, welche magisch über dem Boden zu schweben scheinen, befinden sich auf einer vor Blicken versteckten Basis. Crystal ist eine Sofa- und Sesselfamilie, welche sich von Standard und Gemeinplätzen unterscheidet und ein Gefühl des Schwebens und der Dynamik schafft ohne unnötige ästhetische Schöpfungen zu benutzen, aber auf eine wissentliche und uneingeschränkte Schlichtheit pocht.

Fr Des angles obliques qui font penser aux formes des obélisques anciens, en créant un jeu architectonique de lumières et d'ombres. Des volumes pleins qui semblent flotter sur le sol d'une manière magique, sur une base cachée à la vue. Crystal est une famille de canapés et de fauteuils qui s'éloigne des standards et des lieux communs, en engendrant un sens de suspension et de dynamisme, sans utiliser d'inutiles artifices esthétiques, mais en misant sur une simplicité aussi vivante qu'absolue.



PearsonLloyd

PearsonLloyd is one of the leading names in contemporary British design, and this multidisciplinary studio works in a wide range of sectors: from furnishing to public spaces to brand development. Established by Luke Pearson and Tom Lloyd in 1997, the studio has received numerous acknowledgements and accolades in both Europe and the United States. The British design duo write regularly for major design magazines, as well as acting as "visiting lecturers" at the École Cantonale d'Art in Lausanne.

Other products by PearsonLloyd:
 Crystal (Sofa) ↪ Vol. A p.098, Eddy ↪ p.240,
 Fixie ↪ p.252, Galleria ↪ Vol. A p.148, Ischia ↪ Vol. A p.124, Nebula (Tacchini Edizioni), Polar ↪ Vol. A p.162,
 Polar Perch ↪ Vol. A p.170, Polar Table ↪ p.312,
 Quilt ↪ Vol. A p.062, Stone High/Low ↪ Vol. A p.180

Technical informations



Armchair ↪ p.329



Sofa ↪ p.329

Crystal (Armchair)
 W 96 D 80 H 68 cm
 H seat 43 cm

Crystal (Sofa)
 Vol. A ↪ p.098

Sancarlo (Armchair),
 base T06 Grey ↪ p.120

Cage (Low Table), top T32
 Black Marquinia Marble,
 base T07 Black ↪ p.302

Isola

In una situazione d'attesa le persone tendono naturalmente ad assumere una postura più rilassata, soprattutto mentre usano computer, laptop e smartphone per lavoro o passatempo.

Informazioni → p.119



Isola (Armchair),
base T24 Satin Chrome
W 118 D 86,5 H 85 cm
H seat 40 cm

Designer, Year:
Claesson Koivisto Rune, 2012

Da questa riflessione è nata Isola, una poltrona dal design contemporaneo che risponde all'esigenza di vivere comodamente anche i luoghi pubblici o semi-pubblici. Isola è caratterizzata da una forma visivamente accogliente e invitante, e da una seduta ampia e profonda. La possibilità di combinare la seduta con un tavolino ovale, integrato sul lato destro o sinistro, la rende ancora più funzionale, incoraggiandone l'uso in ogni ambito del contract.



Isola (Armchair),
base T03 Grey
W 118 D 86,5 H 85 cm
H seat 40 cm

Cage (Low Table),
top T41 Smoked Mirror,
base T27 Matt Black
Chrome ↗ p.302



Isola (Armchair), base T24
Satin Chrome, table top
T34 Shiny Bianco Marble
W 118 D 86,5 H 85 cm
H seat 40 / H table 57,5 cm

Isola

En In waiting spaces, people naturally tend to assume a relaxed posture, particularly while using their computer, laptop or smartphone for work or to pass the time. This consideration was the starting point for the conception of Isola, an armchair with a contemporary design that responds to the need for comfort in public or semi-public places. Isola features a visually inviting shape, and a broad, deep seat. The possibility of combining the seat with an oval table, built into the left or right side, makes it even more practical, and ideal for use in all contract situations.

De Beim Warten nehmen Menschen unwillkürlich eine entspannte Haltung ein, vor allem wenn sie mit Computer, Laptop oder Smartphone arbeiten oder sich die Zeit vertreiben. Das ist der Grundgedanke für das Design von Isola, ein zeitgenössisch anmutender Fauteuil, der dem Bedürfnis nach Komfort auch in öffentlichen oder halb-öffentlichen Räumen Rechnung trägt. Charakteristisch für Isola sind die bereits für das Auge behaglich einladende Form und die großzügige, tiefe Sitzfläche. Durch ein ovales Tischchen, das rechts oder links angebaut werden kann, ist das Möbel noch funktioneller und eine ideale Lösung auch für den Objektbereich.

Fr Dans une situation d'attente, les personnes tendent naturellement à prendre une posture plus décontractée, surtout quand elles utilisent l'ordinateur ou un smartphone pour le travail ou comme passe-temps. C'est de cette réflexion qu'est né Isola, un fauteuil au design contemporain qui répond à l'exigence de vivre confortablement y compris dans les lieux publics ou semi-publics. Isola est caractérisé par une forme accueillante et invitante, et par une assise large et profonde. La possibilité d'associer au fauteuil une table basse ovale, intégrée sur le côté droit ou gauche, le rend encore plus fonctionnel et adapté également aux espaces collectifs.



Claesson Koivisto Rune

The Claesson Koivisto Rune studio was established in 1995 as a multidisciplinary architecture and design workshop, in line with the classic Scandinavian tradition, but with the aim of exploring new concepts, and pursuing the values of simplicity and innovation. The three Swedes have created architectural designs throughout the world and in every sector, from homes to restaurants, retail to executive buildings, as well as furniture ranges for numerous major international firms.

Other products by Claesson Koivisto Rune:
Campo (Tacchini Edizioni), Doodle (Armchair, Chaise-longue) → p.082, Doodle (Chair, Stool) → p.228,
Kelly B → p.296, Kelly C → p.202, Kelly C Basic → p.202,
Kelly E → p.072, Kelly H → p.072, Kelly L+F → p.072,
Kelly O → p.296, Kelly S → p.072, Kelly T → p.266,
Kelly V → p.210, Kelly W → p.296, Lima → Vol. A p.078,
Misura S/M → p.150, Montevideo (Sofa, Armchair,
Ottoman) → Vol. A p.056, Montevideo (Chair) → p.222,
Pisa → p.100, Quartier → p.176, Santiago → Vol. A p.070,
Spin → p.182, Split → p.260

Technical informations



Armchair → p.331

Sancarlo

La poltrona Sancarlo è un trattato di statica, ergonomia, funzione e geometria. Achille Castiglioni recupera l'idea della Sanluca, disegnata qualche decennio prima con il fratello Pier Giacomo. Il risultato è la scomposizione della seduta in una serie di cuscini: che si offrono curvi a ognuna delle parti del corpo che dovranno sostenere.

Informazioni → p.125



Sancarlo è la riedizione di un classico firmato da Achille Castiglioni. La seduta, nelle due versioni poltrona e divano, è costituita da una struttura semplice e lineare in tubo curvato, su cui sono posizionati diversi volumi imbottiti. Un concetto all'avanguardia per l'epoca in cui venne presentato, reso ancora più efficace oggi dalle imbottiture differenziate, che cambiano densità in base alla zona del corpo che devono supportare. Seduta di grande personalità, Sancarlo è una vera icona del design del XX secolo.

Designer, Year:
Achille Castiglioni, (1982) 2010

Sancarlo (Armchair),
base T13 Bordeaux
W 62,5 D 92 H 118 cm
H seat 45 cm

→ Tacchini Edizioni:
E63 (Lamp) designed
by Umberto Riva,
Daze (Low Table)
designed by Truly Truly



Sancarlo



Sancarlo (Armchair),
base T13 Bordeaux
W 62,5 D 92 H 118 cm
H seat 45 cm

Sancarlo

Design Classic ↗ p.002
Discover Tacchini
process of re-editions



En The Sancarlo armchair is a treatise on statics, ergonomics, function and geometry. Achille Castiglioni has taken up again the idea of the Sanluca, designed a few decades earlier with his brother Pier Giacomo. The result is the breaking-down of the seat into a series of cushions which curve to each part of the body they have to support. Sancarlo is a reissue of a classic designed by Achille Castiglioni. Both versions, armchair and sofa, are composed of a simple, linear, curved tubular frame, on which a number of upholstered cushions are positioned. A ground-breaking concept when it was first presented, it has now been made even more effective with differentiated foam filling, in which the density varies according to the region of the body to be supported. Full of character, Sancarlo is a veritable icon of 20th-century design.

De Der Sessel Sancarlo ist ein Statement, das für Statik, Ergonomie, Funktion und Geometrie steht. Achille Castiglioni greift die Idee des Sessels Sanluca wieder auf, den er vor einigen Jahrzehnten gemeinsam mit seinem Bruder Pier Giacomo entworfen hat. Ergebnis ist das Zerlegen der Sitzfläche in eine Reihe von Kissen, die mit ihren Rundungen den verschiedenen Körperteilen Halt bieten. Sancarlo ist die Neuauflage eines Design-Klassikers von Achille Castiglioni. Das Sitzmöbel, in den Ausführungen als Fauteuil und Sofa, besteht aus einer schlichten, linearen Struktur aus gebogenem Metallrohr, in die Polsterungen verschiedener Volumen eingesetzt werden. Ein supermodernes Design für die damalige Zeit, das heute durch differenzierte Polsterungen, die je nach dem zu stützenden Körperteil unterschiedliche Härten aufweisen, noch wirkungsvoller ist. Sancarlo ist ein charakterstarkes Sitzmöbel und eine Stilikone des 20. Jahrhunderts.

Fr Le fauteuil Sancarlo est un traité de statique, d'ergonomie, de fonction et de géométrie. Achille Castiglioni reprend l'idée du modèle Sanluca, conçu quelques décennies plus tôt avec son frère Pier Giacomo. Il en résulte une déstructuration du siège en une série de coussins incurvés qui s'offrent à chacune des parties du corps qu'ils devront soutenir. Sancarlo est la réédition d'un classique signé par Achille Castiglioni. Le siège, dans les deux versions fauteuil et canapé, est constitué d'une structure simple et linéaire en tube cintré, sur laquelle sont positionnés les volumes rembourrés. Un concept à l'avant-garde pour l'époque où il fut présenté, rendu encore plus efficace aujourd'hui par les rembourrages différenciés, qui changent de densité en fonction de la zone du corps qu'ils doivent soutenir. Création d'une grande personnalité, Sancarlo est une véritable icône du design du XXe siècle.



Achille Castiglioni

The hero of Italian design, Achille Castiglioni, along with his brothers Pier Giacomo and Livio, was able to find irony and beauty into the simplicity of everyday life. From the simplest electrical switches to the most iconic project of modern design, Castiglioni brothers transformed their uncontrollable curiosity in a series of timeless pieces. Castiglioni was born on 16 February 1918 in Milan, in Lombardy in northern Italy. He was the third son of the sculptor Giannino Castiglioni and his wife Livia Bolla. When the War was over, Castiglioni joined the architectural design practice that his brothers Livio and Pier Giacomo had started with Luigi Caccia Dominioni in 1938. Livio Castiglioni left the practice in 1952. From then until Pier Giacomo died in 1968, he and Achille worked as a team. Achille believed in experimentation; his method was to always start from scratch, stick to common sense, know the end goal and the means to achieve it.

Other products by Achille Castiglioni:
Babela (with Pier Giacomo) ↗ p.216

Technical informations

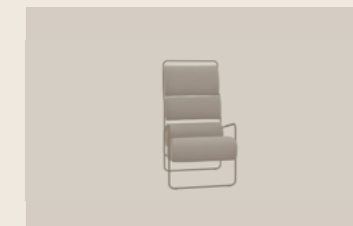

Armchair, Sofa ↗ p.336

Domestic, Contract

Armchair

Baobab

Baobab si distingue per il contrasto fra il volume pieno e rotondeggiante della seduta e il sottile profilo dello schienale.

Informazioni → p.131

Designer, Year:
Lievore Altherr Molina, 2005

Baobab si distingue per il contrasto fra il volume pieno e rotondeggiante della seduta e il sottile profilo dello schienale. Il risultato, oltre a dimostrarsi particolarmente ricco di personalità, è anche piacevolmente comodo e accogliente.



Baobab

Baobab (Armchair)
W 80 D 77 H 69 cm
H seat 40 cm

Coot (Low Table), top
T29 Shiny White
Carrara Marble, base T02
White → p.308





Baobab

En Baobab is characterised by the contrast of the full rounded form of the seat with the fine and elegant profile of the back. The result, quite apart from its unique personality is a very pleasing, comfortable and eye catching piece.

De Baobab zeichnet sich durch den Kontrast der vollen, runden Formen der Sitzfläche und dem schlanken Profil der Rückenlehne aus. Das Ergebnis, mehr als nur Persönlichkeit Baobab ist angenehm einladend und bequem.

Fr Baobab se distingue pour le contraste entre le volume complet et arrondi de l'assise et le profil mince du dossier. Le résultat, outre être particulièrement riche de personnalité, est également agréablement confortable et accueillant.



Lievore Altherr Molina

Born in 1948, Alberto Lievore studied architecture in Buenos Aires. In the early years he focused not only on design, but also on the production and marketing of furniture, then, having moved to Barcelona, he was part of the Grupo Berenguer (1977), a leading name in Spanish design. In 1984 he inaugurated his own studio, focusing on industrial design, and on consultancy and art direction for a number of firms. His partners are designer and stylist Jeannette Altherr, who specializes in objects and spaces for children, and Manel Molina, who again brings with him vast and varied experiences in the industrial and exhibition design sectors.

Other products by Lievore Altherr Molina:
Girola ↪ p.166, Havana ↪ Vol. A p.118, Labanca ↪ Vol. A p.104, Labanca Table ↪ p.320, Nara ↪ p.324

Technical informations



Armchair ↪ p.329

Baobab (Armchair)
W 80 D 77 H 69 cm
H seat 40 cm

Cage (Low Table),
top T31 White
Calacatta Marble,
base T02 White ↪ p.302



Parentesi (Armchair)
W 80 D 65 H 75 cm
H seat 45 cm

Contract

Armchair

Parentesi

Il suo nome, Parentesi, descrive in modo semplice ed efficace questa collezione, caratterizzata da linee curve, nette ed essenziali.

Informazioni → p.132



Designer, Year:
Pietro Arosio, 1997

Parentesi

La poltrona rivisita una forma classica e avvolgente nel segno della versatilità d'ambientazione e composizione.



Parentesi (Armchair)
W 80 D 65 H 75 cm
H seat 45 cm

Roma (Sofa), base T25
Matt Champagne Gold
⇒ Vol. A p.036

⇒ Tacchini Edizioni: Linea
(Rug) designed by
Maria Gabriella Zecca



Parentesi (Armchair)
W 80 D 65 H 75 cm
H seat 45 cm

Parentesi

En Its name means parenthesis: a simple, effective description of this collection, with its clean, essential, curved lines. The armchair revisits a classic, cosy shape with the versatility to fit into any setting or composition.

De Der Name Parentesi, auf Deutsch runde Klammer, beschreibt einfach und wirkungsvoll diese Kollektion, die sich durch saubere, minimalistische Kurvenlinien auszeichnet. Eine klassische, körpernahe Form wird mit diesem Fauteuil neu interpretiert, um in unterschiedliche Umgebung und Zusammenstellung zu passen.

Fr Son nom, Parentesi, décrit de façon simple et efficace cette collection, caractérisée par des lignes courbes nettes et essentielles. Le fauteuil réinterprète une forme classique et enveloppante à l'enseigne de la flexibilité d'intégration et de composition.



Pietro Arosio

Pietro Arosio was born in 1946 in Lissone, near Milan. He learnt his profession at the research centre of a company specialising in the production of metal furniture for communal spaces. This experience led to the emergence of a design philosophy that developed over time through his work as an industrial designer. He began his career in 1972, and was already winning accolades in 1983, receiving the Casaviva d'Oro award. The fundamentals of his work include essentiality, research into new materials and technologies, and attention to detail and to the engineering implications of his designs. Pietro Arosio is fully aware of the emotional impact his products can have, and has worked in partnership with various internationally-acclaimed artists, including Nespolo, Del Pezzo, Hsiao Chin, Tilson, Rotella and Keizo. A number of his pieces have been exhibited at the Victoria and Albert Museum in London, and at the Munich modern art museum Die Sammlung.

Other products by Pietro Arosio:
Intercity ⇨ Vol. A p.190, Moon ⇨ p.144, Quadro ⇨ Vol. A p.084, Slalom ⇨ p.192, Sliding ⇨ Vol. A p.112, XL ⇨ p.162

Technical informations



Armchair ⇨ p.334

Domestic, Contract

Armchair, Sofa, Chair

Mayfair

Compatta e avvolgente, la collezione Mayfair ha un'estetica unica e riconoscibile, lineare come un unico foglio ricurvo all'esterno e piacevolmente morbida all'interno.

Informazioni → p.143



Mayfair (Armchair)
L 64 P 69 H 82 cm
H seat 44 cm

Soap (Low Table), top T74
Marmo Sahara Noir,
base T03 Grey → p.290

Designer, Year:
Christophe Pillet, 2008

La poltroncina è completamente rivestita in pelle o tessuto ed è caratterizzata dal particolare dettaglio delle cuciture a vista, che sottolineano le curve dello schienale.

Mayfair

Mayfair (Armchair)
L 64 P 69 H 82 cm
H seat 44 cm

Split (Low Table), top T33
Matt Black Travertine
Marble, base T07 Black
→ p.260

→ Tacchini Edizioni: Campo
(Rug) designed by
Claesson Koivisto Rune





Mayfair (Armchair)
L 64 P 69 H 82 cm
H seat 44 cm

Mayfair

En Compact and curvaceous, the Mayfair collection has a unique and distinctive linear aesthetic, like a single curved leaf on the outside, and pleasingly soft in the inside. The easy chair is entirely covered in leather or fabric, and features characteristic visible stitching details that emphasise the curved back.

De Kompakt und körpernah, zeichnet sich die Kollektion Mayfair durch eine besondere, sofort wiedererkennbare Ästhetik aus: linear wie ein nach außen gewölbtes Blatt, angenehm weich im Inneren. Der Sessel ist vollständig mit Leder oder Stoff bezogen. Charakteristisch sind die Nähte auf Sicht, die das runde Design der Rückenlehne effektiv unterstreichen.

Fr Compacte et enveloppante, la collection Mayfair a une esthétique unique et reconnaissable, linéaire comme une unique feuille courbe à l'extérieur et agréablement moelleuse à l'intérieur. Le fauteuil est entièrement revêtu de cuir ou de tissu et est caractérisé par le détail des coutures apparentes qui soulignent les courbes du dossier.



Christophe Pillet

This lodestar in French design gained a Master's degree in Design in Milan in 1985, before working with Philip Starck in Paris from 1988 to 1993, after which he set up his own independent, eclectic business, featuring his hallmark style – simple, strong, and to the point – be it in architecture or interior design, furniture, fashion or industrial design. Winner of the French "Créateur de l'année" award in 1994, Pillet works with some of the biggest names in contemporary furniture design.

Other products by Christophe Pillet:
Mayfair (Chair) ⇨ p.246, Memory Lane ⇨ p.196,
SouthBeach ⇨ p.170

Technical informations



Armchair, Sofa ⇨ p.333

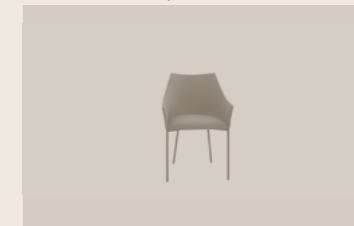

Chair ⇨ p.333

Domestic, Contract

Armchair

Moon

Moon è una poltrona che si distingue nell'universo dell'arredo per la sua forma avvolgente e dinamica.

Informazioni → p.149

Designer, Year:
Pietro Arosio, 2002

Grazie a un particolare procedimento produttivo, la scocca girevole in poliuretano forma un tutto unico con il rivestimento, dando vita a una seduta che è la perfetta combinazione di design e abilità tecnica.



Moon

Moon (Armchair),
base T95 Mud
W 83,5 D 73 H 89 cm
H seat 38 cm

Spin (Ottoman)
→ p.182





Moon (Armchair),
base T20 Black
W 83,5 D 73 H 89 cm
H seat 38 cm

Moon

En Moon is an armchair with a uniquely curvaceous and dynamic shape. The special production process creates a swivelling polyurethane shell that forms a single body with the covering, to give a seat that represents the perfect combination of design and technical skill.

De Moon ist ein Fauteuil, der sich von anderen Polstermöbeln durch seine körpernahe, dynamische Form abhebt. Dank einem besonderen Produktionsverfahren bilden die drehbare Sitzschale aus Polyurethan und der Bezug eine Einheit für ein Sitzmöbel, in dem Design und technisches Können eine perfekte Verbindung eingehen.

Fr Moon est un fauteuil qui se distingue dans l'univers du meuble pour sa forme enveloppante et dynamique. Grâce à un procédé de production particulier, la coque pivotante en polyuréthane forme un tout avec le revêtement, en donnant vie à un siège qui est une combinaison parfaite de design et d'habileté technique.



Pietro Arosio

Pietro Arosio was born in 1946 in Lissone, near Milan. He learnt his profession at the research centre of a company specialising in the production of metal furniture for communal spaces. This experience led to the emergence of a design philosophy that developed over time through his work as an industrial designer. He began his career in 1972, and was already winning accolades in 1983, receiving the Casaviva d'Oro award. The fundamentals of his work include essentiality, research into new materials and technologies, and attention to detail and to the engineering implications of his designs. Pietro Arosio is fully aware of the emotional impact his products can have, and has worked in partnership with various internationally-acclaimed artists, including Nespolo, Del Pezzo, Hsiao Chin, Tilson, Rotella and Keizo. A number of his pieces have been exhibited at the Victoria and Albert Museum in London, and at the Munich modern art museum Die Sammlung.

Other products by Pietro Arosio:
Intercity → Vol. A p.190, Parentesi → p.132,
Quadro → Vol. A p.084, Slalom → p.192, Sliding → Vol. A
p.112, XL → p.162

Technical informations

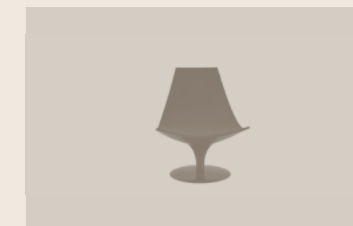

Armchair → p.334

Misura

Elegantemente composta, accogliente, discreta, ma di forte personalità. La collezione di poltrone by Claesson Koivisto Rune, che misura il design nella progettualità di segno e proporzione, delle parti e del tutto.

Informazioni → p.155



Misura S (Armchair)
W 61 D 66 H 77 cm
H seat 46 cm

Soap (Low Table), top T31
White Calacatta Marble,
base T25 Matt Champagne
Gold → p.290

La collezione di sedute Misura propone una versione più piccola, con la poltroncina da tavolo Misura S, perfetta nelle sale riunioni o per i tavoli da pranzo, e una versione dalle dimensioni più ampie, la poltrona Misura M, pensata per le sale d'attesa degli ambienti contract e pubblici o negli studi professionali, così come per lo spazio domestico dedicato al relax. L'ampia gamma di finiture disponibili veste la collezione di molteplici stili.

Designer, Year:
Claesson Koivisto Rune, 2007



Misura S (Armchair)
W 61 D 66 H 77 cm
H seat 46 cm

Cage (Low Table), top T31
White Calacatta Marble,
base T25 Matt Champagne
Gold → p.302

→ Tacchini Edizioni:
Linea (Rug) and Vasum
(Vase) designed by
Maria Gabriella Zecca



Misura



Misura M (Armchair)
W 76 D 70 H 77 cm
H seat 42 cm

Misura

En Dignified elegance – comfortable, subtle but with bold personality. The armchair collection by Claesson Koivisto Rune measures design in the concept of looks and proportions, the parts and the whole. The Misura collection includes the Misura S, a smaller version, perfect around a table, whether in a meeting room or a dining room; and a larger version, the Misura M, designed for public or contract waiting rooms or professional offices, as well as the home for relaxation any time. The broad range of finishes dresses the collection in many different styles.

De Elegant, behaglich, diskret, aber mit starker Persönlichkeit. Die Kollektion mit Sesseln der Designer Claesson Koivisto Rune misst das Design an der Gestaltung der Linien und Proportionen sowohl der einzelnen Teile als auch des Gesamtbildes. Die Kollektion Misura gibt es auch in der kleineren Version Misura S mit einem Armsessel für den Tisch, der perfekt ist für Besprechungszimmer oder für den Esstisch, und in einer größeren Version Misura M, die für Wartebereiche in Objekteinrichtungen oder öffentlichen Gebäuden und in Büros oder Studios und für den Wohnbereich zu Hause gedacht ist. Die breite Palette der verfügbaren Oberflächen bietet zahlreiche stilistische Varianten.

Fr Élégamment composée, accueillante, discrète, néanmoins dotée d'une forte personnalité. La collection de fauteuils de Claesson Koivisto Rune mesure le design dans l'élaboration du signe et de la proportion, des parties et du tout. La collection de sièges Misura se décline en une version de petite taille, le fauteuil de table Misura S, idéal dans les salles de réunion ou pour les tables de repas, et une version plus grande, le fauteuil Misura M, conçu pour les salles d'attente dans les espaces contract et publics ou dans les cabinets professionnels, ainsi que pour les espaces domestiques dédiés à la détente. La large gamme de finitions disponibles permet à la collection d'arborer différents styles.



Claesson Koivisto Rune

The Claesson Koivisto Rune studio was established in 1995 as a multidisciplinary architecture and design workshop, in line with the classic Scandinavian tradition, but with the aim of exploring new concepts, and pursuing the values of simplicity and innovation. The three Swedes have created architectural designs throughout the world and in every sector, from homes to restaurants, retail to executive buildings, as well as furniture ranges for numerous major international firms.

Other products by Claesson Koivisto Rune:
Campo (Tacchini Edizioni), Doodle (Armchair, Chaise-longue) → p.082, Doodle (Chair, Stool) → p.228, Isola → p.114, Kelly B → p.296, Kelly C → p.202, Kelly C Basic → p.202, Kelly E → p.072, Kelly H → p.072, Kelly L+F → p.072, Kelly O → p.296, Kelly S → p.072, Kelly T → p.266, Kelly V → p.210, Kelly W → p.296, Lima → Vol. A p.078, Montevideo (Sofa, Armchair, Ottoman) → Vol. A p.056, Montevideo (Chair) → p.222, Pisa → p.100, Quartier → p.176, Santiago → Vol. A p.070, Spin → p.182, Split → p.260

Technical informations



Armchair → p.334

Domestic

Armchair

Glide

L'ispirazione per Glide è stata l'osservazione della natura, il fluido e continuo passaggio da una forma a un'altra.

Informazioni → p.161

Designer, Year:
Monica Förster, 2006

L'ispirazione per Glide è stata l'osservazione della natura, il fluido e continuo passaggio da una forma a un'altra e da uno stato all'altro, come la neve che si scioglie in primavera. La seduta, sostenuta da una leggera base in metallo, è ampia e sottile, comoda perché realizzata in poliuretano espanso a quote differenziate che accoglie il corpo in un abbraccio aereo e spontaneo.



Glide (Armchair),
base T07 Black
W 106 D 65 H 61 cm
H seat 37 cm





Glide

En The inspiration for Glide came from observing nature, the constant, flowing transformation from one state to another, like snow melting in springtime. The light metal base supports a broad, slender seat made in comfortable variable-density polyurethane foam that envelops the body in a spontaneous, airy embrace.

De Die erste Inspiration für Glide kommt aus der Beobachtung der Natur, dem fließenden, dauernden Übergang von einer Form zur anderen, von einem Zustand zum anderen: wie der Schnee im Frühling. Ein Konzept, aus dem ein großzügiges, weiches und schlankes Sitzmöbel entstanden ist, hergestellt aus PU-Schaum in differenzierten Höhen und getragen von Metallstützen, das den Körper in einer lockeren, spontanen Umarmung aufnimmt.

Fr L'inspiration de départ pour Glide est l'observation de la nature, le passage fluide et continu d'une forme à une autre, d'un état à l'autre: comme la neige au printemps. Un concept d'où naît une assise ample, moelleuse et fine, réalisée en polyuréthane expansé à densité variable, soutenue par d'élégants supports métalliques, qui accueille le corps dans une étreinte aérienne et spontanée.



Monica Förster

One of the best-loved interpreters of contemporary Swedish design, Monica Förster works in Stockholm, but she was born and raised close to the Arctic Circle, and this environment has had a clear influence on her work, seen in a deep love for the purest of shapes and for natural sources of inspiration, alongside a curiosity for new materials and technologies. She works with numerous international clients, often inventing new typologies of products in industrial, furniture and object design. She has received accolades including the Excellent Swedish Design award, the Design Plus award in Germany and the Future Design Days Award.

Technical informations



Armchair → p.331

Glide (Armchair),
base T07 Black
W 106 D 65 H 61 cm
H seat 37 cm

XL

L'essenzialità assoluta del disegno incontra la generosità delle dimensioni in questa poltrona dal profilo sottile.

Informazioni → p.165

Designer, Year:
Pietro Arosio, 2000

L'essenzialità assoluta del disegno incontra la generosità delle dimensioni in questa poltrona dal profilo sottile e dalla seduta ampia e comoda. Versatile perché compatibile con ogni contesto, per il suo stile minimale e deciso XL si può accostare ai più diversi elementi d'arredo.





XL (Armchair)
W 80 D 71 H 71 cm
H seat 35 cm

XL

En Absolutely essential design is combined with generous proportions to give a chair with a slim profile and a broad, comfortable seat. It has the versatility to be compatible with any setting, and with its distinctive, minimal style, XL looks great with the widest range of furniture.

De Extrem minimalistisches Design und großzügige Maße verbinden sich zu einem Fauteuil mit schlankem Profil und breiter, bequemer Sitzfläche. XL verträgt sich mit jedem Ambiente und kann dank des minimalistischen, kraftvollen Stils mit unterschiedlichsten Einrichtungsstücken eingesetzt werden.

Fr Le design essentiel rencontre la générosité des dimensions dans ce fauteuil au profil fin et à l'assise large et confortable. Polyvalent, XL s'intègre dans tous les contextes, et grâce à son style minimaliste et à ses lignes nettes, il peut être associé aux éléments de mobilier les plus variés.



Pietro Arosio

Pietro Arosio was born in 1946 in Lissone, near Milan. He learnt his profession at the research centre of a company specialising in the production of metal furniture for communal spaces. This experience led to the emergence of a design philosophy that developed over time through his work as an industrial designer. He began his career in 1972, and was already winning accolades in 1983, receiving the Casaviva d'Oro award. The fundamentals of his work include essentiality, research into new materials and technologies, and attention to detail and to the engineering implications of his designs. Pietro Arosio is fully aware of the emotional impact his products can have, and has worked in partnership with various internationally-acclaimed artists, including Nespolo, Del Pezzo, Hsiao Chin, Tilson, Rotella and Keizo. A number of his pieces have been exhibited at the Victoria and Albert Museum in London, and at the Munich modern art museum Die Sammlung.

Other products by Pietro Arosio:
Intercity ⇨ Vol. A p.190, Moon ⇨ p.144,
Parentesi ⇨ p.132, Quadro ⇨ Vol. A p.084,
Slalom ⇨ p.192, Sliding ⇨ Vol. A p.112

Technical informations



Armchair ⇨ p.338

Girola

Una poltrona girevole che avvolge totalmente il corpo e ruota completamente su sé stessa.

Informazioni → p.169



Girola (Armchair)
W 87 D 74 H 64 cm
H seat 40 cm

→ Tacchini Edizioni:
Nello Spazio (Rug)
designed by Umberto Riva

Designer, Year:
Lievore Altherr Molina, 2004

Una poltrona girevole che avvolge totalmente il corpo e ruota completamente su sé stessa, grazie ad un meccanismo a sfera collocato nella base. Un elemento d'arredo originale e confortevole, adatto a porsi al centro di qualsiasi spazio. Struttura in legno multistrato di betulla, con imbottitura in poliuretano espanso a quote differenziate.



Girola (Armchair)
W 87 D 74 H 64 cm
H seat 40 cm

Girola

En A swivel armchair which enfolds the body and rotates fully on its own axis thanks to a ball mechanism in the base. An original and comfortable item of furniture, suitable for placing in the centre of any space. The frame is in beech plywood, upholstered in differentiated-density polyurethane foam.

De Ein Drehstuhl, der den Körper perfekt umschließt und sich durch einen Kugelmechanismus im Untergestell vollständig selbst drehen kann. Ein originelles und bequemes Einrichtungselement, das in jedem Raum zum Mittelpunkt werden kann. Struktur aus Mehrschichtholz Birke, Polsterung aus PU-Schaumstoff unterschiedlicher Stärken.

Fr Un fauteuil pivotant qui enveloppe complètement le corps et tourne complètement sur soi, grâce à un mécanisme à billes placé dans le piétement. Un élément d'ameublement original et confortable, pouvant être placé au centre de n'importe quel espace. Structure en multiplis de bouleau, avec rembourrage en polyuréthane expansé de hauteurs différentes.



Lievore Altherr Molina

Born in 1948, Alberto Lievore studied architecture in Buenos Aires. In the early years he focused not only on design, but also on the production and marketing of furniture, then, having moved to Barcelona, he was part of the Grupo Berenguer (1977), a leading name in Spanish design. In 1984 he inaugurated his own studio, focusing on industrial design, and on consultancy and art direction for a number of firms. His partners are designer and stylist Jeannette Altherr, who specializes in objects and spaces for children, and Manel Molina, who again brings with him vast and varied experiences in the industrial and exhibition design sectors.

Other products by Lievore Altherr Molina:
Baobab ↪ p.126, Havana ↪ Vol. A p.118,
Labanca ↪ Vol. A p.104, Labanca Table ↪ p.320,
Nara ↪ p.324

Technical informations



Armchair ↪ p.330

Domestic, Contract

Armchair

SouthBeach

Suggestivo come un trono, avvolgente come una culla, una seduta che unisce i concetti di forza e di morbidezza in un unico oggetto d'arredo.

Informazioni → p.175

Designer, Year:
Christophe Pillet, 2006

La sinuosa struttura, realizzata con listelli in massello di faggio, avvolge e sostiene la seduta e il poggiatesta in multistrato di betulla, rivestiti in tessuto. Un pezzo importante, destinato a catalizzare l'attenzione in qualsiasi spazio venga collocato: domestico o collettivo.



SouthBeach

SouthBeach (Armchair),
frame T21 White
W 110 D 68 H 139 cm
H seat 43 cm



SouthBeach (Armchair),
frame T21 White
W 110 D 68 H 139 cm
H seat 43 cm

Polar Table (Low Table),
finish T21 White ↗ p.312

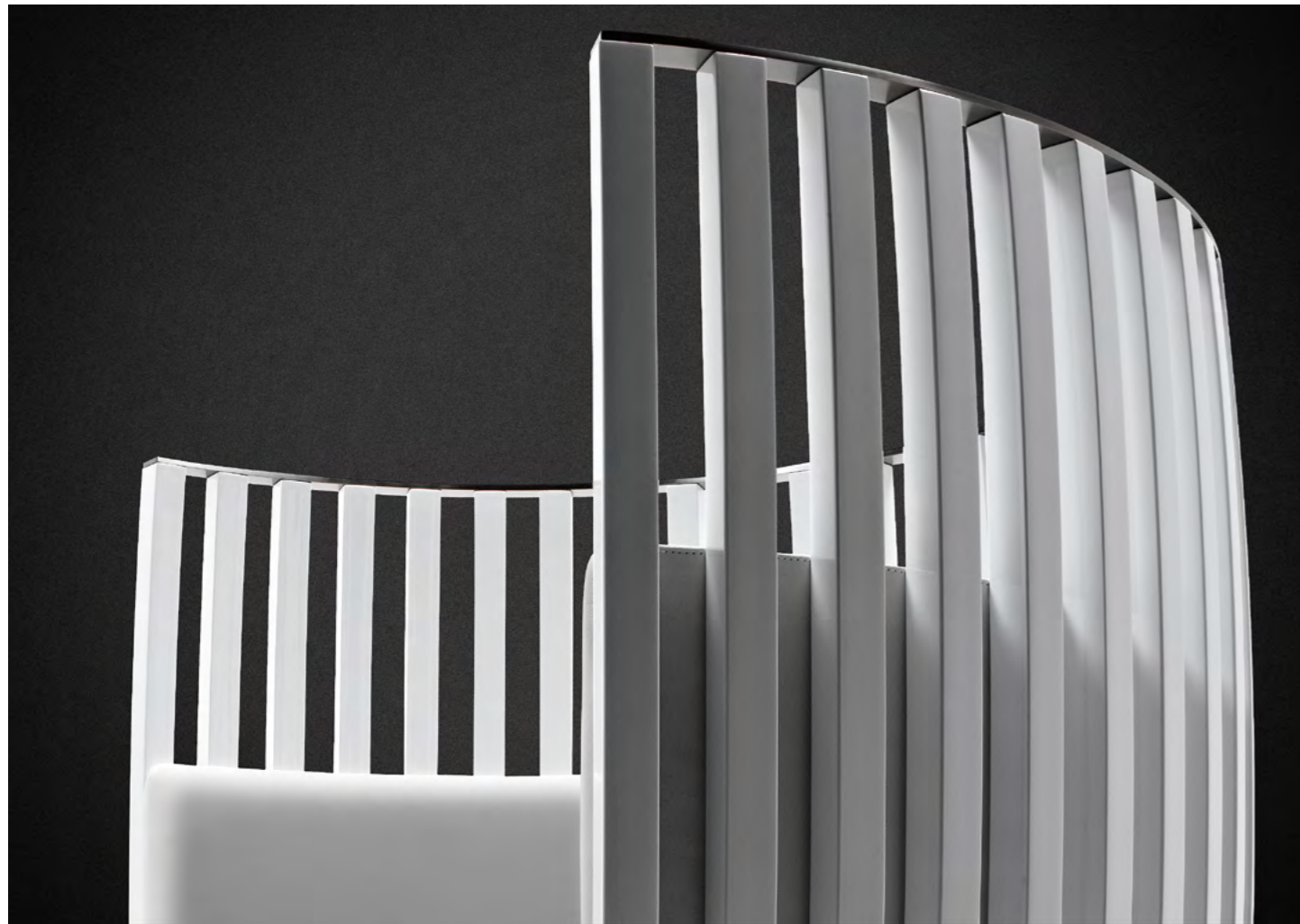

SouthBeach

En As fascinating as a throne and as protective as a cradle, a seat that combines the concepts of strength and softness in a single piece of furniture. The sleek structure, made from solid beech strips, surrounds and supports the seat and the headrest in birch plywood with fabric upholstery. An important piece, destined to grab attention in whatever space it is placed, whether in the home or in the community.

De Imposant wie ein Thron, beschützend wie eine Wiege, ein Sitzmöbel, das Kraft und flauschige Weichheit in einem Einrichtungsobjekt vereint. Die Struktur in geschwungenen Linien aus Buchen-Massivholzleisten, umfängt und stützt Sitzschale und Kopfstütze aus Birke-Mehrschichtholz, die mit Stoff bezogen sind. Ein edles Stück und Blickfang in jedem Lebensraum: in der Wohnung oder im Gemeinschaftsraum.

Fr Suggestif comme un trône, enveloppant comme un berceau, un siège qui associe les concepts de force et de douceur dans un unique objet. La structure sinueuse, réalisée avec des lattes en hêtre massif, enveloppe et soutient l'assise et l'appuie-tête en multiplis de bouleau, recouverts de tissu. Une pièce d'ameublement importante, destinée à catalyser l'attention quel que soit l'espace qui l'accueille: domestique ou collectif.



Christophe Pillet

This lodestar in French design gained a Master's degree in Design in Milan in 1985, before working with Philip Starck in Paris from 1988 to 1993, after which he set up his own independent, eclectic business, featuring his hallmark style – simple, strong, and to the point – be it in architecture or interior design, furniture, fashion or industrial design. Winner of the French “Créateur de l'année” award in 1994, Pillet works with some of the biggest names in contemporary furniture design.

Other products by Christophe Pillet:
Mayfair → p.138, Mayfair (Chair) → p.246,
Memory Lane → p.196

Technical informations



Armchair → p.337

SouthBeach (Armchair),
frame T21 White
W 110 D 68 H 139 cm
H seat 43 cm

Quartier

Una metropoli di edifici in miniatura, colorati, soffici e accoglienti, per arredare il paesaggio domestico e collettivo

Informazioni → p.181



Una metropoli di edifici in miniatura, colorati, soffici e accoglienti, per arredare il paesaggio domestico e collettivo: questa è l'idea creativa da cui nascono i nuovi pouf Quartier. Disegnati dallo studio Claesson Koivisto Rune, sono disponibili in tre diverse misure ed in diversi colori. Le loro linee squadrate e le cuciture a vista in tonalità contrastanti, ricordano i palazzi di mattoni dei "cartoon". Una novità giovane e divertente, ma allo stesso tempo pratica e versatile, per dare nuove forme al comfort ed alla convivialità domestica.

Designer, Year:
Claesson Koivisto Rune, 2010

Quartier

Quartier (Ottoman)
W 112 D 112 H 33 H seat 33 cm
W 62 D 62 H 38 H seat 38 cm
W 46 D 46 H 46 H seat 46 cm

Split (Low Table)
→ p.260



Quartier (Ottoman)
W 112 D 112 H 33 cm
W 62 D 62 H 38 cm
W 46 D 46 H 46 cm



Quartier (Ottoman)
W 62 D 62 H 38 cm

Quartier

En A metropolis of buildings in miniature, colourful, soft and cosy, to combine the wide range of differing private and public areas. This is the creative idea from which arise the new ottoman Quartier. Design Claesson Koivisto Rune, available in three different sizes and different colours. Their square lines and visible stitching in contrasting tones, are reminiscent of buildings in a "cartoon" strip. A young and funny new product both practical and versatile at the same time, giving new forms to comfort and conviviality.

De Eine Metropole aus Miniaturgebäuden, farbig, bequem und einladend, um das Wohnumfeld privat und im Objekt zu gestalten: das ist die creative Idee, aus der sich die neuen Sitzkissen Quartier vom Studio Claesson Koivisto Rune entwickeln. Sie sind in drei Maßen und diversen Farben verfügbar. Ihre eckigen Linien und die Nähte in Kontrastfarben erinnern an die Backsteinhäuser der "cartoon". Eine junge und zugleich praktische Neuheit, um Wohnen neue Formen zu geben.

Fr Une métropole d'immeubles en miniature, colorées, souples et accueillantes pour meubler divers espaces publics et privés. C'est de cette idée que sont nés les nouveaux poufs Quartier. Imaginés par le studio Claesson Koivisto Rune, ils sont disponibles en trois différentes dimensions et dans plusieurs coloris. Ses lignes et ses coutures à vue conçues dans des tonalités contrastées, rappellent les palais de briques des "cartoon". Une nouveauté jeune et amusante, pratique et qui s'adapte à diverses ambiances pour donner des nouvelles formes de confort et de convivialité de la maison.



Claesson Koivisto Rune

The Claesson Koivisto Rune studio was established in 1995 as a multidisciplinary architecture and design workshop, in line with the classic Scandinavian tradition, but with the aim of exploring new concepts, and pursuing the values of simplicity and innovation. The three Swedes have created architectural designs throughout the world and in every sector, from homes to restaurants, retail to executive buildings, as well as furniture ranges for numerous major international firms.

Other products by Claesson Koivisto Rune: Campo (Tacchini Edizioni), Doodle (Armchair, Chaise-longue) → p.082, Doodle (Chair, Stool) → p.228, Isola → p.114, Kelly B → p.296, Kelly C → p.202, Kelly C Basic → p.202, Kelly E → p.072, Kelly H → p.072, Kelly L+F → p.072, Kelly O → p.296, Kelly S → p.072, Kelly T → p.266, Kelly V → p.210, Kelly W → p.296, Lima → Vol. A p.078, Misura S/M → p.150, Montevideo (Sofa, Armchair, Ottoman) → Vol. A p.056, Montevideo (Chair) → p.222, Pisa → p.100, Santiago → Vol. A p.070, Spin → p.182, Split → p.260

Technical informations



Ottoman → p.338

Spin

Spin è una famiglia di pouf che riprende la tecnica delle cuciture a vista con andamento casuale, già sperimentata dallo studio Claesson Koivisto Rune.

Informazioni → p.185

Designer, Year:
Claesson Koivisto Rune, 2010

Spin è una famiglia di pouf che riprende la tecnica delle cuciture a vista con andamento casuale, già sperimentata dallo studio Claesson Koivisto Rune nelle sedute Doodle, per disegnare un decoro a spirale giocoso, leggero e quasi ipnotico. Un motivo che caratterizza le forme arrotondate e amichevoli di questi morbidi elementi d'arredo, proposti in diverse dimensioni e tonalità.



Spin

Spin (Ottoman)
Ø 119 H 39 cm
Ø 90 H 39 cm
Ø 60 H 39 cm



Spin

En Spin is a family of ottomans which resumes a technique such as "random" stitching, already applied in the Doodle chairs by designers Claesson Koivisto Rune, that traces soft and playful whirls with an almost hypnotic effect. The stitches characterize the generous, rounded shapes of these soft furnishings, available in different sizes and colours.

De Spin ist eine Familie von Ottomanen, bei der die Technik der Sichtnähte mit Zufallsverlauf wieder aufgenommen wird. Mit dieser Technik hat bereits Claesson Koivisto Rune bei den Doodle-Sitzmöbel experimentiert, um eine spielerisch lockere, leichte, ja beinahe hypnotisierende Verzierung in Spiralform zu entwerfen, ein Motiv, das die abgerundeten und ansprechenden Formen dieser weichen Einrichtungsgegenstände, die in verschiedenen Größen und Farben erhältlich sind, kennzeichnet.

Fr Spin est une famille de pouf, qui reprend la technique de coutures à vue avec une tendance "aléatoire", déjà connue par le Studio Claesson Koivisto Rune dans les assises Doodle, pour dessiner une décoration à spirale plaisante, légère et presque hypnotique. Un motif qui caractérise les formes arrondies et respectueuses de ces éléments d'ameublement, disponibles dans différentes dimensions et couleurs.



Claesson Koivisto Rune

The Claesson Koivisto Rune studio was established in 1995 as a multidisciplinary architecture and design workshop, in line with the classic Scandinavian tradition, but with the aim of exploring new concepts, and pursuing the values of simplicity and innovation. The three Swedes have created architectural designs throughout the world and in every sector, from homes to restaurants, retail to executive buildings, as well as furniture ranges for numerous major international firms.

Other products by Claesson Koivisto Rune: Campo (Tacchini Edizioni), Doodle (Armchair, Chaise-longue) → p.082, Doodle (Chair, Stool) → p.228, Isola → p.114, Kelly B → p.296, Kelly C → p.202, Kelly C Basic → p.202, Kelly E → p.072, Kelly H → p.072, Kelly L+F → p.072, Kelly O → p.296, Kelly S → p.072, Kelly T → p.266, Kelly V → p.210, Kelly W → p.296, Lima → Vol. A p.078, Misura S/M → p.150, Montevideo (Sofa, Armchair, Ottoman) → Vol. A p.056, Montevideo (Chair) → p.222, Pisa → p.100, Quartier → p.176, Santiago → Vol. A p.070, Split → p.260

Technical informations



Ottoman → p.338

Spin (Ottoman)
 Ø 119 H 39 H seat 39 cm
 Ø 90 H 39 H seat 39 cm
 Ø 60 H 39 H seat 39 cm

Domestic, Contract

Atoll

Nata dalla matita del designer francese Patrick Norguet, la chaise longue Atoll disegna il piacere del relax con una linea sensuale e sinuosa, che unisce visione estetica ed ergonomia.

Informazioni → p.191

Chaise-longue

L'elegante leggerezza della seduta allungata offre un avvolgente schienale alto con bracciolo unilaterale. Il volume pieno e definito della scocca si accosta alla sottile essenzialità delle gambe in legno con struttura in metallo. La chaise longue di Norguet è l'arredo ideale per le aree relax di aeroporti, alberghi, centri benessere e per i più curati spazi riservati di strutture aperte al pubblico. Nel contesto domestico crea un ambiente raccolto, raffinato ed estremamente moderno, che invita ad assaporare un prezioso tempo lento.

Awards: 2015 Interior Innovation Awards



Designer, Year:
Patrick Norguet, 2014





Atoll (Chaise-longue)
W 170 D 85,5 H 94 cm
H seat 24,5 cm

Atoll

En From the drawing board of French designer Patrick Norguet, the Atoll chaise longue traces the pleasure of relaxation with sinuous curves that combine aesthetic vision and ergonomics. The ethereal elegance of the elongated seat flows from the high backrest to the single armrest. The full, well-defined proportions of the shell contrast with the sleek simplicity of the wood legs and metal structure. The Norguet chaise longue is ideally suited to furnish relaxation areas in airports, hotels and spas, and a welcome refuge in the more curated private areas of public buildings. At home, it lends an air of cozy, yet very modern, sophistication; an invitation to savor the precious rhythms of slow time.

De Die Chaiselongue Atoll ist dem französischen Designer Partrick Norguet aus der Feder geflossen und steht mit ihrem Design, das durch geschwungene und sinnliche Linien charakterisiert ist und gekonnt Ästhetik mit Ergonomie verbindet, ganz im Zeichen der Entspannung. Die elegante Leichtigkeit der verlängerten Sitzfläche geht in eine komfortable hohe Rückenlehne mit einseitiger Armlehne über. Das volle und definierte Volumen der Sitzschale wird durch die schmalen und minimalistischen Holzbeine mit Metallgestell betont. Die Chaiselongue von Norguet ist perfekt für die Einrichtung von Relax-Zonen in Flughäfen, Hotels und Wellness-Einrichtungen und für reservierte und hochwertige Bereiche in öffentlichen Einrichtungen. Im Wohnbereich lässt sich mit der Chaiselongue ein behagliches, elegantes und extrem modernes Ambiente schaffen, dass dazu einlädt, wertvolle Ruhephasen zu genießen.

Fr Née du crayon du designer français Patrick Norguet, la chaise longue Atoll dessine le plaisir de la détente de sa ligne sensuelle et sinueuse, alliant vision esthétique et ergonomie. L'élégante légèreté de l'assise se prolonge dans le dossier haut et enveloppant avec accoudoir unilatéral. Le volume plein et défini de la coque se rapproche du minimalisme subtil des pieds en bois à structure métallique. La chaise longue de Norguet est idéale pour meubler les espaces de détente d'aéroports, hôtels, centres de bien-être et pour les espaces intimes particulièrement raffinés de structures ouvertes au public. Dans le contexte domestique, elle crée une ambiance privée, raffinée et extrêmement moderne qui invite à savourer la précieuse lenteur du temps.



Patrick Norguet

Patrick Norguet is a key figure in French design today, and was elected "furniture designer of the year" by Wallpaper magazine in 2009. He began his career as a project designer in the late nineties, working with numerous big names in the furniture design world, in addition to completing a number of interior and set design projects. He has always sought to select the right shapes and colours, exuding a love of innovative industrial processes, artisanal ateliers and the people working there.

Other products by Patrick Norguet:
Dot → p.090, Jacket → p.094

Technical informations



Chaise-longue → p.339

Domestic, Contract

Slalom

Una chaise-longue dalle forme estremamente eleganti ed ergonomiche, che rivela una sorprendente versatilità.

Informazioni → p.195

Designer, Year:
Pietro Arosio, 2002

Chaise-longue

Una chaise-longue dalle forme estremamente eleganti ed ergonomiche, che rivela una sorprendente versatilità. Può infatti assumere due diverse inclinazioni, con la semplice rotazione del basamento. Il cuscino poggiatesta è a sua volta collocabile in diverse posizioni a piacere, grazie a un magnete.





Slalom

En A chaise-longue with extremely elegant and ergonomic form and which is able to offer a surprising versatility. It can be set to a different position of inclination simply by rotating the base. The head rest can be fixed in various positions by means of a simple magnet.

De Eine sehr elegante und ergonomische Liege, Durch einfaches Drehen des Untergestells ist ihre Neigung auf zwei Positionen verstellbar. Das Kopfkissen hält durch Magneten in verschiedenen Positionen.

Fr Une chaise-longue avec des formes très élégantes et ergonomiques, qui révèle une versatilité surprenante. Elle peut prendre deux inclinaisons différentes, avec une simple rotation de la base. L'appui-tête oreiller est à son tour positionné dans différentes positions, grâce à un aimant.



Pietro Arosio

Pietro Arosio was born in 1946 in Lissone, near Milan. He learnt his profession at the research centre of a company specialising in the production of metal furniture for communal spaces. This experience led to the emergence of a design philosophy that developed over time through his work as an industrial designer. He began his career in 1972, and was already winning accolades in 1983, receiving the Casaviva d'Oro award. The fundamentals of his work include essentiality, research into new materials and technologies, and attention to detail and to the engineering implications of his designs. Pietro Arosio is fully aware of the emotional impact his products can have, and has worked in partnership with various internationally-acclaimed artists, including Nespolo, Del Pezzo, Hsiao Chin, Tilson, Rotella and Keizo. A number of his pieces have been exhibited at the Victoria and Albert Museum in London, and at the Munich modern art museum Die Sammlung.

Other products by Pietro Arosio:
Intercity ⇨ Vol. A p.190, Moon ⇨ p.144,
Parentesi ⇨ p.132, Quadro ⇨ Vol. A p.084,
Sliding ⇨ Vol. A p.112, XL ⇨ p.162

Technical informations



Chaise-longue ⇨ p.339

Slalom (Chaise-longue)
W 56 D 160/168 H 98/78 cm
H seat 31/19 cm

Domestic, Contract

Chair

Memory Lane Outdoor/Indoor

Christophe Pillet disegna una sedia senza tempo, universale, radicalmente semplificata nel suo design.

Informazioni → p.201

Designer, Year:
Christophe Pillet, 2018

L'eleganza di Memory Lane sta proprio nel rifiuto di ogni complessità: l'esile struttura in metallo e la raffinata imbottitura impunturata, con cinghie elastiche che restano visibili nella parte posteriore della seduta, ne fanno un vero manifesto alla semplicità. Una sedia pensata per ambienti contract, dove far convivere bellezza e comfort.



Memory Lane
Outdoor

Memory Lane Outdoor (Chair),
base T15 Turquoise
W 59 D 65,5 H 84 H seat 52 cm

→ Tacchini Edizioni: Tarsia
(Tray) designed by
Maria Gabriella Zecca



Memory Lane Indoor (Chair),
base T107 Green Bronze
W 59 D 65,5 H 84 H seat 52 cm

Memory Lane
Indoor

Memory Lane Indoor (Chair),
base T107 Green Bronze
W 59 D 65,5 H 84 H seat 52 cm





Memory Lane Indoor (Chair),
base T107 Green Bronze
W 59 D 65,5 H 84 H seat 52 cm

Memory Lane Outdoor/Indoor

En Christophe Pillet designs a chair that is timeless, universal and radically simplified in its design. Memory Lane's elegance lies in its outright rejection of any hint of complexity. The slender metal structure and sophisticated top-stitched upholstery, with elastic webbing visible on the back of the seat, make it a true declaration of simplicity. A chair designed for the contract market, where beauty and comfort stylishly coexist.

De Christophe Pillet entwirft einen zeitlosen Stuhl, überall einsetzbar und in einem radikal essentiellen Design. So liegt die Eleganz von Memory Lane gerade im Verzicht auf jede Komplexität: die schlanke Metallstruktur und die raffinierte, gesteppte Polsterung, mit elastischen Gurten, die auf der Unterseite der Sitzfläche sichtbar bleiben, verstärken den Eindruck von Schlichtheit. Ein Stuhl für den Objektbereich, bei dem sich elegante Ästhetik und Komfort verbinden.

Fr Christophe Pillet dessine une chaise intemporelle, universelle, radicalement simplifiée dans son design. L'élégance de Memory Lane tient précisément au refus de toute complexité : la fine structure en métal et le rembourrage raffiné, rythmé par les surpiqûres, avec des sangles élastiques qui restent visibles dans la partie arrière, en font un véritable manifeste de la simplicité. Une chaise pensée pour les collectivités, où la beauté et le confort cohabitent.



Christophe Pillet

This lodestar in French design gained a Master's degree in Design in Milan in 1985, before working with Philip Starck in Paris from 1988 to 1993, after which he set up his own independent, eclectic business, featuring his hallmark style – simple, strong, and to the point – be it in architecture or interior design, furniture, fashion or industrial design. Winner of the French "Créateur de l'année" award in 1994, Pillet works with some of the biggest names in contemporary furniture design.

Other products by Christophe Pillet:
Mayfair → p.138, Mayfair (Chair) → p.246,
SouthBeach → p.170

Technical informations

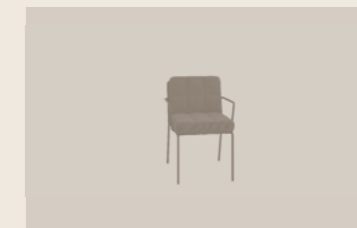

Chair → p.343

Domestic, Contract

Chair, Armchair, Ottoman, Chaise-longue,
Stool, Table, Low Table

Kelly C/C Basic

Ispirato al mondo dell'artista statunitense Ellsworth Kelly, fatto di forme semplici e colori puri, Kelly è uno dei progetti più amati dal trio di designer Mårten Claesson, Eero Koivisto e Ola Rune.

Informazioni → p.209



Kelly C (Chair),
base T03 Grey
W 52 D 51 H 79 cm
H seat 45,5 cm

Kelly T (Table),
top T53 Grey, base T03
Grey → p.266

Designer, Year:
Claesson Koivisto Rune, 2014

Kelly C

Ispirata alle opere dell'artista minimalista Ellsworth Kelly, la sedia omonima è caratterizzata da una sottile struttura metallica e dalla scocca imbottita dalla forma semplice e lineare. Una seduta essenziale e preziosa per contesti colti ed eleganti, sia domestici sia del contract, che si può affiancare ai tavoli della stessa collezione.





Kelly C Basic (Chair),
base T04 Grey
W 56 D 53 H 82 cm
H seat 45



Kelly C Basic (Chair),
base T04 Grey
W 56 D 53 H 82 cm
H seat 45

Kelly C/C Basic

En The designer drew inspiration from the work of minimalist artist Ellsworth Kelly, creating a chair with slender metal legs and a padded shell with a simple, linear shape. An essential, sleek chair for cultured and elegant settings, both domestic and contract, which can be perfectly accompanied by the tables from the same collection.

De Angeregt durch die minimalistischen Werke von Ellsworth Kelly, hat der gleichnamige Stuhl sein prägendes Merkmal in der schlanken Metallstruktur mit gepolsterter Sitzschale in schlichter, linearer Form. Ein essentielles, edles Sitzmöbel für ein exklusives, elegantes Ambiente im Wohn- und Objektbereich, das mit Tischen der gleichen Kollektion einsetzbar ist.

Fr S'inspirant des œuvres de l'artiste minimaliste Ellsworth Kelly, la chaise du même nom est caractérisée par une fine structure métallique et par la coque rembourrée à la forme simple et linéaire. Une chaise essentielle et précieuse pour des contextes raffinés et élégants, domestiques ou collectifs, qui peut être associée aux tables de la même collection.



Claesson Koivisto Rune

The Claesson Koivisto Rune studio was established in 1995 as a multidisciplinary architecture and design workshop, in line with the classic Scandinavian tradition, but with the aim of exploring new concepts, and pursuing the values of simplicity and innovation. The three Swedes have created architectural designs throughout the world and in every sector, from homes to restaurants, retail to executive buildings, as well as furniture ranges for numerous major international firms.

Other products by Claesson Koivisto Rune: Campo (Tacchini Edizioni), Doodle (Armchair, Chaise-longue) → p.082, Doodle (Chair, Stool) → p.228, Isola → p.114, Kelly B → p.296, Kelly E → p.072, Kelly H → p.072, Kelly L+F → p.072, Kelly O → p.296, Kelly S → p.072, Kelly T → p.266, Kelly V → p.210, Kelly W → p.296, Lima → Vol. A p.078, Misura S/M → p.150, Montevideo (Sofa, Armchair, Ottoman) → Vol. A p.056, Montevideo (Chair) → p.222, Pisa → p.100, Quartier → p.176, Santiago → Vol. A p.070, Spin → p.182, Split → p.260

Technical informations

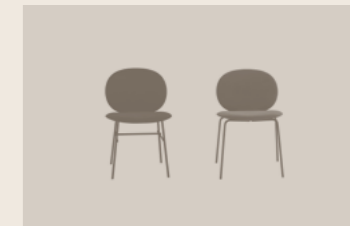

Chair (Kelly C/C Basic/S/P) → p.342



Low Table (Kelly B/O/W) → p.351



Chair (Kelly V) → p.343



Table (Kelly T) → p.345



Armchair (Kelly E/H/L+F) → p.332

Domestic, Contract

Kelly V

Il carattere unico e irripetibile degli oggetti di design nasce da queste silenziose rivoluzioni che trasformano forme familiari, usuali e riconoscibili in progetti iconici che catturano lo spirito del proprio tempo.

Informazioni → p.215



Designer, Year:
Claesson Koivisto Rune, 2016

Chair, Armchair, Ottoman, Chaise-longue,
Stool, Table, Low Table

Contraddistinta dall'accattivante forma arrotondata e dalla sottile struttura metallica verniciata o cromata, la sedia Kelly V in legno si presenta in tre nuove versioni. Ricco di charme e prestigio artigianale, il modello con scocca bicolore orizzontale, in legno di un colore più chiaro o più scuro sulla fascia anteriore in alto e sul retro, nelle tonalità azzurro, grigio e marrone. Tutti i modelli sono impilabili: una dote salvaspazio particolarmente apprezzata nel contract.



Kelly V (Chair), base T07
Black, seat T52 Black
W 56 D 53 H 82 cm
H seat 45 cm



Kelly V

Kelly V (Chair), base T05
Grey, seat Light Blu
W 56 D 53 H 82 cm
H seat 45 cm

Kelly T (Table), top T54
Concrete Grey,
base T05 Grey → p.266



Kelly V (Chair), base T05
Grey, seat Light Blu
W 56 D 53 H 82 cm
H seat 45 cm

Kelly T (Table), top T54
Concrete Grey,
base T05 Grey ↪ p.266

Kelly V

En The unique character of design objects results from these silent revolutions that transform familiar usual and recognizable forms into iconic projects that capture the spirit of their time. Marked by a captivating rounded shape and a thin painted or chromed metallic structure, Kelly V wooden chair presents three new versions. Rich of charm and artisan prestige, the model with horizontal bicolor structure, with darker or lighter wood on the top and on the back, dyed light blue, grey and brown. All models are stackable: a feature that allows to save space, particularly appreciated in the contract market.

De Der einzigartige und einmalige Charakter der Design-Objekte entsteht aus dieser stillen Revolution, die vertraute, gewöhnliche und erkennbare Formen in ikonische Projekte verwandeln und damit den Zeitgeist einfängt. Der Stuhl Kelly V, charakteristisch und attraktiv mit gerundeter Form und schlankem Metallgestell, lackiert oder verchromt, präsentiert sich in drei neuen Ausführungen. Mit handwerklichem Charme und Prestige das Modell mit horizontal zweifarbiger Sitzschale, aus Holz, in einer helleren oder dunkleren Tönung der obere Streifen auf der Vorderseite und die Rückseite, in den Farben Hellblau, Grau und Braun. Alle Modelle sind stapelbar, eine vorteilhafte Eigenschaft besonders im Objektbereich.

Fr Le caractère unique et irremplaçable des objets de design vient de ces révolutions silencieuses qui transforment des formes familières, habituelles et reconnaissables en projets emblématiques qui capturent l'esprit de leur temps. Charme incontestable et prestige artisanal pour le modèle avec coque bicolore horizontale, en bois d'une couleur plus claire ou plus foncée sur la bande supérieure devant et derrière, dans les teintes bleu ciel, gris et marron. Tous les modèles sont empilables : une solution gain de place particulièrement appréciée dans les fournitures pour les collectivités.



Claesson Koivisto Rune

The Claesson Koivisto Rune studio was established in 1995 as a multidisciplinary architecture and design workshop, in line with the classic Scandinavian tradition, but with the aim of exploring new concepts, and pursuing the values of simplicity and innovation. The three Swedes have created architectural designs throughout the world and in every sector, from homes to restaurants, retail to executive buildings, as well as furniture ranges for numerous major international firms.

Other products by Claesson Koivisto Rune:
Campo (Tacchini Edizioni), Doodle (Armchair, Chaise-longue) ↪ p.082, Doodle (Chair, Stool) ↪ p.228, Isola ↪ p.114, Kelly B ↪ p.296, Kelly C ↪ p.202, Kelly C Basic ↪ p.202, Kelly E ↪ p.072, Kelly H ↪ p.072, Kelly L+F ↪ p.072, Kelly O ↪ p.296, Kelly S ↪ p.072, Kelly T ↪ p.266, Kelly W ↪ p.296, Lima ↪ Vol. A p.078, Misura S/M ↪ p.150, Montevideo (Sofa, Armchair, Ottoman) ↪ Vol. A p.056, Montevideo (Chair) ↪ p.222, Pisa ↪ p.100, Quartier ↪ p.176, Santiago ↪ Vol. A p.070, Spin ↪ p.182, Split ↪ p.260

Technical informations

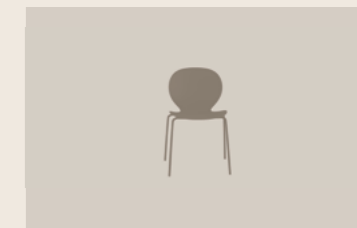

Chair (Kelly V) ↪ p.343



Low Table (Kelly B/O/W) ↪ p.351

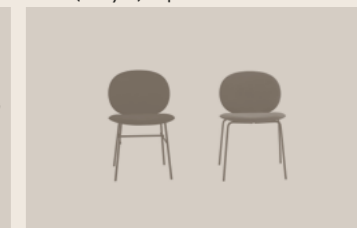

Chair (Kelly C/C Basic/S/P) ↪ p.342



Table (Kelly T) ↪ p.345



Armchair (Kelly E/H/L+F) ↪ p.332

Babela

Ci sono progetti che nascono classici già nei nomi che portano. Babela è uno di quei progetti e di quei nomi. Nel 1958 Achille Castiglioni disegna questa poltroncina per completare l'arredamento della Camera di commercio di Milano: il comfort si incontra con la forma e la funzionalità, svelata nella possibilità di poter impilare questa seduta, come una torre.

Informazioni → p.221



Designer, Year:
Achille + Pier Giacomo
Castiglioni, 1958 (2010)

Progettata nel 1958 da Achille e Pier Giacomo Castiglioni per la Camera di Commercio di Milano, Babela è un ottimo esempio di come funzionalità ed estetica possano coesistere nella stessa seduta, una poltroncina comoda e impilabile dal disegno rigoroso, in linea con l'ambiente istituzionale per cui è pensata. La riedizione porta Babela dentro spazi contemporanei, trasformando la struttura in ferro dell'originale in una base in legno di frassino, più caldo e naturale.



Babela (Chair),
base T48 Grey
W 56 D 59 H 80 cm
H seat 49 cm

→ Tacchini Edizioni:
Pi-Dou (Vase) designed
by Alvino Bagni

Split (Table), top T110 Sand,
base T112 Sand → p.260





Babela (Chair), base T46 White
W 56 D 59 H 80 H seat 49 cm

Babela

Design Classic ↗ p.002
Discover Tacchini
process of re-editions

There are designs which are born classics in name only. Babela is one of those designs and one of those names. In 1958 Achille Castiglioni designed this small armchair to add to the furniture of the Milan chamber of commerce. Comfort meets form and function which is revealed in the possibility of stacking this seat up like a tower. Its design was simple and archetypical, with a particular mixture of materials, visual texture and tactile effects.



Achille + Pier Giacomo Castiglioni

The Castiglioni studio was established in 1938 by brothers Livio and Pier Giacomo, while for certain projects, Luigi Caccia Dominioni also worked alongside them. In 1944 Achille joined the studio: the partnership between the three brothers continued until 1952, when Livio set up on his own, while continuing to work with Pier Giacomo and Achille for some special projects. Achille and Pier Giacomo worked together without any clear division of roles, but with equal participation, and constant discussion and exchange of ideas. This collaboration continued until Pier Giacomo died in 1968. Achille continued to work in the same way as he always had done with his brother, and indeed it is almost impossible to detect any difference in his approach to projects, other than the natural social and technological changes that came about with the evolving times.

En Designed in 1958 by Achille and Pier Giacomo Castiglioni for the Milan Chamber of Commerce, Babela is an excellent example of how practicality and aesthetics can work together in the same chair, a comfortable, stackable easy chair with a rigorous design perfect for the institutional setting for which it was conceived. This reissue brings Babela into contemporary spaces, transforming the original iron frame into a warmer, more natural ash wood one.

De Babela, 1958 von Achille und Pier Giacomo Castiglioni für die Handelskammer Mailand entworfen, beweist sehr schön, dass Funktion und Ästhetik in einem Sitzmöbel gemeinsam bestehen können: der bequeme Sessel ist stapelbar, das rigorose Design passt genau in die förmliche Umgebung, für die es entworfen wurde. Für die Neuauflage, die Babela in zeitgemäße Räume führt, wurde die eiserne Struktur durch eine warme, natürliche Basis aus Eschenholz ersetzt.

Fr Conçue en 1958 par Achille et Pier Giacomo Castiglioni pour la Chambre de commerce de Milan, Babela est un excellent exemple de comment la fonctionnalité et l'esthétique peuvent coexister dans le même siège, un petit fauteuil confortable et empilable au dessin rigoureux, adapté au contexte institutionnel pour lequel il a été conçu. La réédition porte Babela dans des espaces contemporains, en transformant la structure en fer de l'original en une base en bois de frêne, plus chaud et naturel.

Technical informations



Chair ↗ p.339

Domestic, Contract

Chair, Sofa, Armchair, Ottoman

Montevideo

Gambe snelle e forme avvolgenti per la sedia Montevideo, un progetto che non sacrifica sicuramente la comodità all'eleganza.

Informazioni → p.227



Designer, Year:
Claesson Koivisto Rune, 2008

La morbida imbottitura in gomma accoglie il corpo, garantendo un relax perfetto. Il rivestimento sfoderabile la rende particolarmente pratica nell'utilizzo, in qualsiasi contesto d'arredo, sempre con una personalità speciale.







Montevideo (Chair),
base T08 Brown
W 54 D 62 H 80 cm
H seat 47 cm

Split (Table), top T33 Matt
Black Travertine Marble,
base T08 Brown ↪ p.260

Montevideo

En With its slender legs and soft shapes, the Montevideo chair certainly does not trade in comfort for elegance. The soft foam cushion envelops the body, ensuring perfect relaxation. The removable cover makes it particularly handy in any context of use, always with its own special character.

De Schlanke Beine und gemütliche Formen für den Stuhl Montevideo, ein Projekt, das die Gemütlichkeit auf keinen Fall der Eleganz opfert. Die weiche Gummifüllung nimmt den Körper so auf, dass perfektes Erholen gewährleistet wird. Der abziehbare Bezug ist praktisch im Gebrauch, aber auch geeignet für jeden Einrichtungskontext und zeugt immer von ganz besonderer Persönlichkeit.

Fr Des pieds fins et des formes enveloppantes pour la chaise Montevideo, un projet qui ne sacrifie certainement pas la commodité à l'élégance. Le rembourrage moelleux en mousse accueille le corps, en garantissant un relax parfait. Son revêtement déhoussable lui offre une grande praticité d'utilisation, dans n'importe quel contexte d'ameublement et toujours avec une personnalité spéciale.



Claesson Koivisto Rune

The Claesson Koivisto Rune studio was established in 1995 as a multidisciplinary architecture and design workshop, in line with the classic Scandinavian tradition, but with the aim of exploring new concepts, and pursuing the values of simplicity and innovation. The three Swedes have created architectural designs throughout the world and in every sector, from homes to restaurants, retail to executive buildings, as well as furniture ranges for numerous major international firms.

Other products by Claesson Koivisto Rune: Campo (Tacchini Edizioni), Doodle (Armchair, Chaise-longue) ↪ p.082, Doodle (Chair, Stool) ↪ p.228, Isola ↪ p.114, Kelly B ↪ p.296, Kelly C ↪ p.202, Kelly C Basic ↪ p.202, Kelly E ↪ p.072, Kelly H ↪ p.072, Kelly L+F ↪ p.072, Kelly O ↪ p.296, Kelly S ↪ p.072, Kelly T ↪ p.266, Kelly V ↪ p.210, Kelly W ↪ p.296, Lima ↪ Vol. A p.078, Misura S/M ↪ p.150, Montevideo (Sofa, Armchair, Ottoman) ↪ Vol. A p.056, Pisa ↪ p.100, Quartier ↪ p.176, Santiago ↪ Vol. A p.070, Spin ↪ p.182, Split ↪ p.260

Technical informations

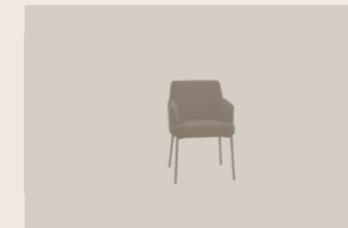

Chair ↪ p.344



Armchair ↪ p.344



Ottoman ↪ p.344



Sofa ↪ p.344

Domestic, Contract

Chair, Stool, Armchair, Chaise-longue

Doodle

Come la poltrona della stessa collezione, anche la sedia e lo sgabello sono ispirati ai “doodle”, disegni tracciati distrattamente mentre si pensa ad altro.

Informazioni → p.233

Come la poltrona della stessa collezione, anche la sedia e lo sgabello sono ispirati ai doodle, disegni tracciati distrattamente mentre si pensa ad altro e ripresi, in queste sedute, nelle cuciture a vista tono su tono o a contrasto con la tinta del rivestimento. Progettati per rispondere alle più diverse esigenze, sedie e sgabelli Doodle arredano ambienti domestici così come luoghi del contract, dagli spazi di lavoro a quelli dell'ospitalità.

Designer, Year:
Claesson Koivisto Rune, 2008



Doodle (Chair),
base T93 Metalgrey
W 51 D 57 H 80 cm
H seat 45 cm





Doodle (Stool),
base T07 Black
W 49 D 53 H 100 cm
H seat 76 cm

Doodle

En Like the armchair from the same collection, the chair and stool also draw their inspiration from doodles, which are depicted here in the visible tone-on-tone or contrasting stitching in the covering. Designed to fulfil a wide range of needs, Doodle chairs and stools are equally well-suited to home and contract settings, from the workplace through to the hospitality sector.

De Wie der Sessel der Kollektion, lassen sich auch Stuhl und Hocker von doodles anregen, unbewusst hingeworfene Linien, wenn die Gedanken woanders sind. In diesen Sitzmöbeln werden sie in den Nähten auf Sicht in der gleichen Farbe wie der Bezug oder von diesem farblich abgesetzt, wieder aufgegriffen. Die Stühle und Hocker Doodle wurden für unterschiedliche Bedürfnisse entworfen und passen ebenso in die Wohnung, in das Büro wie in gastgewerbliche Räume.

Fr Comme le fauteuil de la même collection, la chaise et le tabouret s'inspirent eux aussi des gribouillages, dessins griffonnés distraitemment en pensant à autre chose et repris, dans ces sièges, dans les coutures apparentes ton sur ton ou en contraste sur la couleur du revêtement. Conçus pour répondre aux exigences les plus variées, les chaises et les tabourets Doodle s'intègrent dans un intérieur comme dans un lieu public, des espaces de travail aux espaces d'accueil.



Claesson Koivisto Rune

The Claesson Koivisto Rune studio was established in 1995 as a multidisciplinary architecture and design workshop, in line with the classic Scandinavian tradition, but with the aim of exploring new concepts, and pursuing the values of simplicity and innovation. The three Swedes have created architectural designs throughout the world and in every sector, from homes to restaurants, retail to executive buildings, as well as furniture ranges for numerous major international firms.

Other products by Claesson Koivisto Rune:
Campo (Tacchini Edizioni), Doodle (Armchair, Chaise-longue) → p.082, Isola → p.114, Kelly B → p.296, Kelly C → p.202, Kelly C Basic → p.202, Kelly E → p.072, Kelly H → p.072, Kelly L+F → p.072, Kelly O → p.296, Kelly S → p.072, Kelly T → p.266, Kelly V → p.210, Kelly W → p.296, Lima → Vol. A p.078, Misura S/M → p.150, Montevideo (Sofa, Armchair, Ottoman) → Vol. A p.056, Montevideo (Chair) → p.222, Pisa → p.100, Quartier → p.176, Santiago → Vol. A p.070, Spin → p.182, Split → p.260

Technical informations

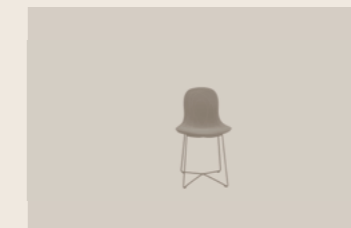

Chair → p.340



Stool → p.340

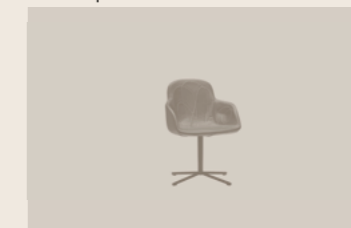

Armchair → p.340

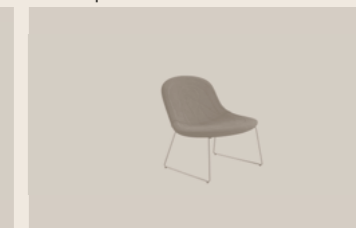

Chaise-longue → p.340

T-Chair

La sedia T-Chair è costituita da un sottile telaio in profilo rettangolare di ferro, curvato e verniciato.

Informazioni → p.239



Designer, Year:
B/M, 2011

La sedia T-Chair è costituita da un sottile telaio in profilo rettangolare di ferro, curvato e verniciato, sul quale sono fissate le forme morbide del sedile e dello schienale, realizzati in legno oppure imbottiti e rivestiti con tessuti di eleganza sartoriale. Semplice, versatile e raffinata, è adatta a una molteplicità di situazioni, dalla casa agli ambienti collettivi, anche grazie alla sua impilabilità.





T-Chair (Chair), base T02 White,
seat T45 Natural Ash, wooden version
W 48 D 55 H 82 H seat 47 cm

T-Chair

En The T-Chair is made of a thin rectangular iron frame that is curved and painted. Secured onto the frame are then the seat and backrest, made of wood or upholstered with sartorially elegant fabrics. Straightforward, versatile and stylish, it fits in with a variety of settings, from household interiors to public spaces, also because it is easily stackable.

De Der Stuhl T-Chair besteht aus einem dünnen Rahmen mit rechteckigem Eisenprofil, gebogen und lackiert, auf welchem die gemütlichen Formen des Sitzes und der Rückenlehne montiert wurden, die aus Holz bestehen oder mit Stoffen von ganz besonderer Eleganz gepolstert und bezogen sind. Einfach, vielseitig und raffiniert fügt er sich in vielfältige Situationen ein, vom Wohnbereich bis hin zu öffentlichen Räumlichkeiten, auch dank der Stapelmöglichkeit.

Fr La chaise T-Chair est constituée par un fin châssis en profil rectangulaire de fer, courbe et verni, sur lequel sont fixées les formes douces du siège et du dossier, réalisés en bois ou bien rembourrés et revêtus avec des tissus à l'élégance de couturier. Simple, versatile et raffinée, elle est adaptée à une multiplicité de situations, de la maison aux espaces collectifs et ce grâce aussi à son empilabilité.



B/M

Roberto Barazzuol and Cristian Malisan come from different backgrounds within the design world, but they share the same passion for the history of design and of the visual arts. In 2010 they established a research, art direction, corporate image, exhibition and product design atelier together. Their focus is on contemporary codes of communication, and they are drawn to the evocative features of products. They take a tailor-made approach to the companies with which they work, handling products and graphics as well as image, fabrics, exhibitions and sets, and anything else you can imagine or design.

Technical informations

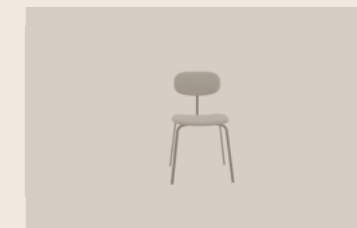

Chair → p.344

Eddy

Firmata dallo studio di design inglese PearsonLloyd, Eddy è un elemento d'arredo di forte fascino. Poltroncina dal volume compatto e dalle dimensioni contenute, è caratterizzata dalla particolare linea e dalla raffinata possibilità di personalizzazione del rivestimento.

Informazioni → p.245

Designer, Year:
PearsonLloyd, 2010

La forma rotondeggiante dello schienale e il particolare taglio tra schienale e seduta, che costituisce un punto di fuga nell'estetica del modello e contemporaneamente una funzionale presa per lo spostamento della poltroncina, sono enfatizzati nella finitura con profilo a contrasto, declinazione inedita dal forte appeal cromatico. Disponibile in due versioni, con piedini o base girevole rotonda, Eddy offre una grande versatilità di utilizzo, nello spazio domestico e nel contract, come negli ambienti office e nell'hôtellerie.







Eddy (Chair)
W 61 D 62 H 78 cm
H seat 45 cm

Eddy

En From the British PearsonLloyd design studio, Eddy is a boldly charming chair. This sleek, compact armchair features distinctive lines and ample opportunities for customization in choice of upholstery. An aesthetic convergence point is formed where the rounded shape of the backrest and the opening between and the seat meet. At the same time, the space serves as a practical handhold to easily move the chair. Contrasting piping adds unique color-driven appeal. Available in two versions, with feet or round swivel base, Eddy offers the utmost in versatility, whether at home or in contract settings, as in offices and hotels.

De Der Sessel Eddy wurde vom englischen Designstudio PearsonLloyd entworfen und setzt starke Akzente. Der Polsterstuhl mit kompakten Abmessungen und diskretem Volumen ist durch seine besondere Linie und die Möglichkeit zur Personalisierung des eleganten Bezugs charakterisiert. Die runde Form der Rückenlehne und die besondere Aussparung zwischen Rückenlehne und Sitzfläche, die die Ästhetik des Modells auflockert und gleichzeitig ein praktischer Griff zum Anheben des Polsterstuhls ist, werden vom Bezug mit Kontrastprofil unterstrichen, das dem Stuhl seinen besondere farblichen Charme verleiht. Eddy ist mit Beinen oder mit rundem Drehfuß erhältlich und vielseitig einsetzbar, im privaten Bereich ebenso wie bei der Objekteinrichtungen, in Büroräumen und im Hotelgewerbe.

Fr Eddy est un meuble au charme fou qui porte la signature de l'agence de design britannique PearsonLloyd. Ce petit fauteuil, au volume compact et de petites dimensions, se démarque par une ligne originale et la possibilité de personnaliser élégamment le revêtement. La forme arrondie du dossier et la découpe singulière entre le dossier et l'assise, qui constitue à la fois un point de fuite au niveau esthétique et une poignée fonctionnelle pour déplacer le fauteuil, sont soulignées dans la finition par un cordon contrastant, déclinaison inédite et chromatiquement accrocheuse. Disponible en deux versions, avec pieds ou base pivotante ronde, Eddy est très polyvalent et trouve sa place dans les espaces domestiques et contract, comme dans les environnements de bureau et dans l'hôtellerie.



PearsonLloyd

PearsonLloyd is one of the leading names in contemporary British design, and this multidisciplinary studio works in a wide range of sectors: from furnishing to public spaces to brand development. Established by Luke Pearson and Tom Lloyd in 1997, the studio has received numerous acknowledgements and accolades in both Europe and the United States. The British design duo write regularly for major design magazines, as well as acting as "visiting lecturers" at the École Cantonale d'Art in Lausanne.

Other products by PearsonLloyd:
Crystal (Sofa) ⇨ Vol. A p.098, Crystal (Armchair) ⇨ p.108, Fixie ⇨ p.252, Galleria ⇨ Vol. A p.148, Ischia ⇨ Vol. A p.124, Nebula (Tacchini Edizioni), Polar ⇨ Vol. A p.162, Polar Perch ⇨ Vol. A p.170, Polar Table ⇨ p.312, Quilt ⇨ Vol. A p.062, Stone High/Low ⇨ Vol. A p.180

Technical informations



Chair ⇨ p.341

Mayfair

La sedia Mayfair riprende la forma avvolgente dell'omonima poltroncina, ma la rende leggera grazie alle sottili gambe in metallo.

Informazioni → p.251



Mayfair (Chair),
base T94 Bronze
W 57 D 56 H 80 cm
H seat 45,5 cm

Designer, Year:
Christophe Pillet, 2008

Per il suo design particolare che non dimentica funzionalità e comodità, Mayfair è la seduta perfetta da accostare a un tavolo, in ambienti domestici ma anche all'interno di ristoranti e luoghi dell'ospitalità.



Mayfair (Chair),
base T94 Bronze
W 57 D 56 H 80 cm
H seat 45,5 cm

Split (Table),
base T94 Bronze
→ p.260



Mayfair

En Mayfair reception chair reflects the same curvaceous form as the easy chair, but its slim metal legs make it lighter. Its distinctive design is both practical and comfortable, making Mayfair the perfect chair for sitting at a table, be it in the home or in restaurants and other hospitality settings.

De Der Stuhl Mayfair übernimmt die körpernahe Form des gleichnamigen Sessels, dem aber die schlanken Beine aus Metall eine besondere Leichtigkeit verleihen. Das originelle, aber auch zweckmäßige und bequeme Design macht Mayfair zum idealen Sitzmöbel für jeden Tisch, im häuslichen Bereich ebenso wie in Restaurants und anderen gastgewerblichen Räumen.

Fr La chaise Mayfair reprend la forme enveloppante du fauteuil mais la rend plus légère grâce aux pieds fins en métal. Grâce à son design particulier qui ne néglige pas la fonctionnalité et le confort, Mayfair est la chaise parfaite à associer à une table, dans des environnements domestiques mais aussi dans un restaurant ou tout autre lieu consacré à l'accueil du public.



Christophe Pillet

This lodestar in French design gained a Master's degree in Design in Milan in 1985, before working with Philip Starck in Paris from 1988 to 1993, after which he set up his own independent, eclectic business, featuring his hallmark style – simple, strong, and to the point – be it in architecture or interior design, furniture, fashion or industrial design. Winner of the French "Créateur de l'année" award in 1994, Pillet works with some of the biggest names in contemporary furniture design.

Other products by Christophe Pillet:
 Mayfair → p.138, Memory Lane → p.196,
 SouthBeach → p.170

Technical informations

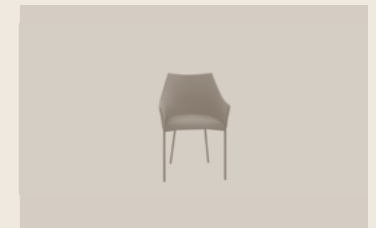

Chair → p.333



Armchair, Sofa → p.333

Mayfair (Chair),
 base T02 White
 W 57 D 56 H 80 cm
 H seat 45,5 cm

Fixie

Fixie è uno sgabello realizzato con una struttura tubolare che oltre ad essere pratica, caratterizza il prodotto e lo rende immediatamente riconoscibile, come un motivo grafico tridimensionale o una scultura d'arredo.

Informazioni → p.259

Designer, Year:
PearsonLloyd, 2011

Questo effetto è accentuato dall'utilizzo di colorazioni originali che rendono Fixie ancora più unico. La qualità estetica non va a discapito della funzionalità: lo sgabello è infatti regolabile in altezza e girevole a 360°.









Fixie (Stool), base T14 Green
W 37 D 37 H 68/80 cm

Fixie

En Fixie is a stool featuring a functional tubular structure which deeply identifies the product, making it instantly recognizable as a 3D graphic pattern or a furniture sculpture. This effect is enriched by original colours making Fixie definitely unique. The aesthetic quality does not hide its functionality: the stool is adjustable in height and it's 360° revolving.

De Fixie ist ein Hocker, der aus einer Rohrstruktur realisiert wurde, welche das Produkt charakterisiert und es sofort unvergleichlich wie ein dreidimensionales graphisches Motiv oder eine Einrichtungsskulptur erscheinen lässt. Dieser Effekt wird noch mehr durch die originelle Farbgebung hervorgerufen und lässt Fixie so noch einzigartiger erscheinen. Die ästhetische Qualität nimmt der Funktionalität jedoch nichts: der Hocker ist höhenverstellbar und um 360° drehbar.

Fr Fixie est un tabouret réalisé avec une structure tubulaire, qui est pratique mais qui caractérise aussi le produit et le rend reconnaissable immédiatement, comme un motif graphique tridimensionnel ou une sculpture de décoration. Cet effet est accentué par l'utilisation de colorations originales qui rendent Fixie encore plus unique. La qualité esthétique ne nuit pas à la fonctionnalité : en effet le tabouret est réglable en hauteur et il pivote à 360°.



PearsonLloyd

PearsonLloyd is one of the leading names in contemporary British design, and this multidisciplinary studio works in a wide range of sectors: from furnishing to public spaces to brand development. Established by Luke Pearson and Tom Lloyd in 1997, the studio has received numerous acknowledgements and accolades in both Europe and the United States. The British design duo write regularly for major design magazines, as well as acting as "visiting lecturers" at the École Cantonale d'Art in Lausanne.

Other products by PearsonLloyd:
Crystal (Sofa) ↪ Vol. A p.098, Crystal (Armchair) ↪ p.108, Eddy ↪ p.240, Galleria ↪ Vol. A p.148, Ischia ↪ Vol. A p.124, Nebula (Tacchini Edizioni), Polar ↪ Vol. A p.162, Polar Perch ↪ Vol. A p.170, Polar Table ↪ p.312, Quilt ↪ Vol. A p.062, Stone High/Low ↪ Vol. A p.180

Technical informations



Stool ↪ p.341

Split

Elementi d'arredo essenziali e imprescindibili, tavoli e tavolini della collezione Split accompagnano i gesti dello spazio domestico, così come la quotidianità sempre diversa degli ambienti contract, declinando la bellezza al servizio della funzione.

Informazioni → p.265



La collezione Split, design Claesson Koivisto Rune, comprende tavoli di diverse altezze e misure, con forma rotonda, ovale, rettangolare o quadrata. La base in metallo, elemento unico di grande leggerezza, verniciato in diversi colori, caratterizzato da un segno verticale moderno e geometrico.

Designer, Year:
Claesson Koivisto Rune, 2007

Split

261

Split (Table), top T110 Sand,
base T112 Sand
W 220 D 120 H 72 cm

Babela (Chair),
base T48 Grey → p.216

→ Tacchini Edizioni:
Pi-Dou (Vase) designed
by Alvino Bagni

260





Split (Low Table), top T29
Shiny White Carrara
Marble, base T02 White
Ø 53 H 50 cm

Split

En All-important and necessary accessories, Split coffee and side/ occasional tables fit right into everyday life and also into the daily grind of contract settings: beauty and function in perfect harmony. Designed by Claesson Koivisto Rune, the Split collection includes round, oval, rectangular and square tables in different heights and sizes. The distinctive, streamlined, light metal base is powder-coated and comes in several colors. It features modern vertical geometric lines.

De Die Tische und Couchtische der Kollektion Split sind essentielle und unverzichtbare Einrichtungsgegenstände, die sowohl zu Hause als auch im Alltag in den unterschiedlichen Objekteinrichtungen ihren Platz finden und die Schönheit in den Dienst der Funktionalität stellen. Die Kollektion Split des Designers Rune umfasst Tische unterschiedlicher Höhe und Größe mit runder, ovaler, rechteckiger oder quadratischer Tischplatte. Der Metallfuß mit einzigartiger und extrem leichter Form, der in verschiedenen Farben lackiert werden kann und durch ein vertikales, modernes und geometrisches Element charakterisiert ist.

Fr Les tables et tables basses de la collection Split sont des meubles minimalistes et incontournables qui accompagnent les gestes dans l'espace domestique, ainsi que la vie quotidienne en constante évolution des espaces contract, déclinant la beauté au service de la fonction. Conçue par Claesson Koivisto Rune, la collection Split se compose de tables de différentes hauteurs et tailles, de forme ronde, ovale, rectangulaire ou carrée. Le piètement en métal, élément unique d'une grande légèreté, peint en différentes couleurs et caractérisé par un signe vertical moderne et géométrique.



Claesson Koivisto Rune

The Claesson Koivisto Rune studio was established in 1995 as a multidisciplinary architecture and design workshop, in line with the classic Scandinavian tradition, but with the aim of exploring new concepts, and pursuing the values of simplicity and innovation. The three Swedes have created architectural designs throughout the world and in every sector, from homes to restaurants, retail to executive buildings, as well as furniture ranges for numerous major international firms.

Other products by Claesson Koivisto Rune: Campo (Tacchini Edizioni), Doodle (Armchair, Chaise-longue) → p.082, Doodle (Chair, Stool) → p.228, Isola → p.114, Kelly B → p.296, Kelly C → p.202, Kelly C Basic → p.202, Kelly E → p.072, Kelly H → p.072, Kelly L+F → p.072, Kelly O → p.296, Kelly S → p.072, Kelly T → p.266, Kelly V → p.210, Kelly W → p.296, Lima → Vol. A p.078, Misura S/M → p.150, Montevideo (Sofa, Armchair, Ottoman) → Vol. A p.056, Montevideo (Chair) → p.222, Pisa → p.100, Quartier → p.176, Santiago → Vol. A p.070, Spin → p.182

Technical informations



Table → p.348



Low Table → p.347

Kelly T

I tavoli Kelly formano una famiglia completa di proposte, caratterizzate dallo stesso piacevole linguaggio formale della collezione, fatto di geometrie arrotondate e accoglienti.

Informazioni → p.273



Sono disponibili in diverse tipologie e dimensioni, per soddisfare ogni esigenza in casa, in ufficio o nel contract: quadrati, rettangolari, con basamento centrale o con 4 gambe. La struttura può essere verniciata in diversi colori oppure cromata per gli ambienti più sofisticati. Il piano, anch'esso in diversi colori, può avere una particolare finitura che lo rende vellutato e soffice al tatto.

Designer, Year:
Claesson Koivisto Rune, 2014









Kelly T

En Kelly tables are a complete collection of proposals characterised by the same enjoyable formal language made of rounded and comfortable geometries. They are available in different types and dimensions in order to satisfy every need at home, in the office or for the contract market: square, rectangular, with central base or with four legs. The structure can be painted with different colours or chromed for more sophisticated environments. In different colours the top as well, which can have a particular finish that makes it velvety and soft to the touch.

De Die Kelly Tische bilden eine ganze Familie, die dieselbe freundliche Formsprache der Kollektion sprechen. Zahlreiche Typologien und Dimensionen stehen zur Verfügung: Quadratisch, rechteckig, mit zentralem Fuß oder mit vier Füßen, um jedes Bedürfnis im Haus, Büro oder Objekt zu befriedigen. Die Struktur kann mit verschiedenen Farben lackiert werden, oder sie kann für anspruchsvolle Umgebungen verchromt werden. Die Oberfläche gibt es ebenfalls in verschiedenen Farben, mit einem besonderen Finish, das sich samtig und weich anfasst.

Fr Les tables Kelly forment une famille complète de propositions caractérisées par le même langage formelle de la collection, fait de géométries arrondies et accueillantes. Ils sont disponibles avec des typologies et dimensions différentes pour satisfaire toutes les exigences à la maison, au bureau ou au contract : carrés, rectangulaires, avec base centrale ou quatre pieds. La structure peut être vernie de différentes couleurs ou chromée pour les espaces plus sophistiqués. Le plateau, également de différentes couleurs, peut avoir une finition particulière qui le fait devenir velouté et soyeux au toucher.



Claesson Koivisto Rune

The Claesson Koivisto Rune studio was established in 1995 as a multidisciplinary architecture and design workshop, in line with the classic Scandinavian tradition, but with the aim of exploring new concepts, and pursuing the values of simplicity and innovation. The three Swedes have created architectural designs throughout the world and in every sector, from homes to restaurants, retail to executive buildings, as well as furniture ranges for numerous major international firms.

Other products by Claesson Koivisto Rune: Campo (Tacchini Edizioni), Doodle (Armchair, Chaise-longue) → p.082, Doodle (Chair, Stool) → p.228, Isola → p.114, Kelly B → p.296, Kelly C → p.202, Kelly C Basic → p.202, Kelly E → p.072, Kelly H → p.072, Kelly L+F → p.072, Kelly O → p.296, Kelly S → p.072, Kelly V → p.210, Kelly W → p.296, Lima → Vol. A p.078, Misura S/M → p.150, Montevideo (Sofa, Armchair, Ottoman) → Vol. A p.056, Montevideo (Chair) → p.222, Pisa → p.100, Quartier → p.176, Santiago → Vol. A p.070, Spin → p.182, Split → p.260

Technical informations



Table (Kelly T) → p.345



Chair (Kelly C/C Basic/S/P) → p.342



Low Table (Kelly B/O/W) → p.351

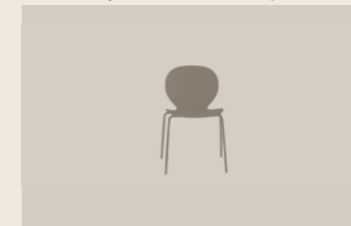

Chair (Kelly V) → p.343



Armchair (Kelly E/H/L+F) → p.332

Kelly T (Table), top
T53 Grey, base T03 Grey
Ø 85 H 72 cm

Kelly C (Chair),
base T03 Grey → p.202

Spindle

Il tema della leggerezza è particolarmente caro al designer dei tavoli Spindle, come base di un approccio progettuale essenziale. Frequente è anche l'ispirazione offerta da oggetti d'uso comune, oppure da archetipi della tradizione: come il fuso per la lana ("spindle" in inglese) che dà il nome a questa collezione di tavoli.

Informazioni → p.281



Collezione di tavoli caratterizzati dalla forma affusolata delle gambe, realizzate in pressofusione di alluminio e raccordate al profilo smussato e sottile del piano, con un effetto di piacevole morbidezza e leggiadria. Le gambe smontabili e l'impilabilità dei tavoli, sono due doti particolarmente indicate per un utilizzo contract, mentre la gamma completa di dimensioni dei piani, di forma quadrata o rettangolare, permette di soddisfare le più diverse esigenze d'uso, sia in ambienti collettivi che residenziali: come scrittoio, tavolo da pranzo o da riunione.

Designer, Year:
Gordon Guillaumier, 2014

Spindle

275

Spindle (Table), top T40
Blue Rear Painted
Glass, base T19 Petrol Blue
W 90 D 90 H 73 cm

Babela (Chair),
base T48 Grey → p.216

274





Spindle (Table), top T40
Blue Rear Painted
Glass, base T19 Petrol Blue
W 90 D 90 H 73 cm

Babela (Chair),
base T48 Grey → p.216

Spindle

Spindle (Table), top T40
Blue Rear Painted
Glass, base T19 Petrol Blue
W 90 D 90 H 73 cm

Babela (Chair),
base T48 Grey → p.216



Spindle



Spindle (Table),
top T38 White Rear Painted
Glass, base T03 Grey
W 145 D 70 H 73 cm

Doodle (Armchair),
base T07 Black
⇒ Vol. A p.082

Spindle

En A collection of tables characterized by tapered legs realized through die casting of aluminium and linked with the thin rounded top that gives a pleasant softness and prettiness. The removable legs and its stackability are two characteristics that make it particularly suitable for the contract use, while the complete range of tops dimensions, square or rectangular, allows to satisfy different needs both in collective and residential environments: like writing desks, dining or meeting tables.

De Kollektion von Tischen, deren FüÙe eine schlanke Form haben, realisiert in Aluminium-Druckguss und verbunden mit einer abgerundeten Tischplatte, die eine weiche und leichte Wirkung hat. Die FüÙe sind zerlegbar und die Tische stapelbar – zwei Eigenschaften, die besonders im Objektbereich wichtig sind. Die Auswahl an Formaten, quadratisch oder rechteckig, erfüllen die Anforderungen sowohl in öffentlichen, als auch in privaten Umgebungen, ob als Schreibtisch, Esstisch oder als Besprechungstisch.

Fr Collection de tables caractérisées par la forme fuselée des pieds, réalisés en aluminium moulé sous pression et raccordés au profil arrondi et fin du plateau avec un effet d'agréable douceur et de grâce. Les pieds démontables et empilables des tables sont deux caractéristiques particulièrement indiquées pour un usage contract, tandis que la gamme complète de dimensions des plateaux, de forme carrée ou rectangulaire, permet de satisfaire les plus diverses exigences d'utilisation dans les espaces collectifs et résidentielles comme bureau, table de repas ou de réunion.



Gordon Guillaumier

Gordon Guillaumier was born in 1966, and was educated firstly in Malta, then in Switzerland, England and Italy. He graduated from IED in Milan (1988-91), before specializing in design at the Domus Academy, Milan (1992). In 1993 he began working with Baleri Associati, as well as collaborating with architect Rodolfo Dordoni. In 2002 he set up his own design studio in Milan, principally working on product design, but also for design consultancy projects. In 2006 he lectured in industrial design at Milan's Politecnico university.

Other products by Gordon Guillaumier:
Cage ⇒ p.302, Chill-Out ⇒ Vol. A p.132, Chill-Out High ⇒ Vol. A p.140, Coot ⇒ p.308, Face To Face ⇒ Vol. A p.044, Ledge ⇒ p.316, Soap ⇒ p.290

Technical informations



Low Table ⇒ p.347

Joaquim

La morbidezza del design brasiliano dei mobili progettati tra gli anni '40 e '60 per le architetture moderniste di Niemeyer, Costa, Vilanova Artigas e Bo Bardi ispira la nuova collezione di tavoli Joaquim di Bonaguro per Tacchini.

Informazioni → p.285



Joaquim (Low Table), top T119
Elegant Brown Marble, base T27 Matt
Black Chrome/top T118 Shiny
Patagonia Marble, base T117 Bronze
Ø 100 H 30 cm

Joaquim (Low Table), top T119 Elegant
Brown Marble, base T27 Matt Black
Chrome/top T118 Shiny Patagonia Marble,
base T27 Matt Black Chrome
Ø 50 H 48 cm

Dal punto di vista estetico, le forme geometriche e lineari sono un omaggio alle linee semplici ed eleganti di Joaquim Tenreiro, considerato uno dei padri del design moderno tropicale, mentre dal punto di vista tecnico la collezione Joaquim è stata progettata pensando al recupero di scarti di lavorazione, in assoluta sintonia con i principi di upcycling ed ecosostenibilità, importanti cardini della creatività brasiliana. I tavoli sono caratterizzati da una struttura in metallo con piani e basi in marmo Patagonia o Elegant Brown.

Awards: 2019 Wallpaper* Design Awards: Best Flashback

Designer, Year:
Giorgio Bonaguro, 2019

Joaquim



Joaquim (Low Table), top
T118 Shiny Patagonia
Marble, base T117 Bronze,
Ø 100 H 30 cm

Lagoa (Armchair)
⇒ p.054

Joaquim

En The softness of Brazilian furniture design between the 40s and 60s in the modernist architecture of Niemeyer, Costa, Vilanova Artigas and Bo Bardi provides the inspiration for the new collection of Joaquim tables by Bonaguro for Tacchini. In aesthetic terms, the linear, geometric shapes are a homage to the simple, elegant lines of Joaquim Tenreiro, considered one of the fathers of modern tropical design. In technical terms, the Joaquim collection was designed to salvage off-cuts, fully embracing the principles of upcycling and environmental sustainability, which are major linchpins of Brazilian creativity. The tables feature a metal frame with tops and bases in Patagonia or Elegant Brown.

De Die fließende Schmiegsamkeit des brasilianischen Möbeldesigns, das zwischen den vierziger und sechziger Jahren für die Architekturen des Modernismus von Niemeyer, Costa, Vilanova Artigas und Bo Bardi entstand, inspiriert ebenfalls die neue Kollektion der Tische Joaquim von Bonaguro für Tacchini. Vom Standpunkt der Ästhetik her gesehen, sind die linearen, geometrischen Formen eine Anerkennung an die schlichten, eleganten Linien von Joaquim Tenreiro, der als einer der Vorläufer des modernen tropischen Designs gilt. Von der technischen Seite her gesehen, wurde die Kollektion Joaquim so entworfen, dass sie der Wiederverwertung von Bearbeitungsabfällen Rechnung trägt, in absolutem Einklang mit den Prinzipien des Upcyclings und der Umweltverträglichkeit, wichtige Fundamente der brasilianischen Kreativität. Die Tische zeichnen sich durch eine Metallstruktur aus, mit Platte und Fuß aus Patagonia Marmor oder Elegant Brown.

Fr La douceur du design brésilien des meubles conçus entre les années 1940 et 1960 pour les architectures modernistes de Niemeyer, Costa, Vilanova Artigas et Bo Bardi inspire la nouvelle collection de tables Joaquim de Bonaguro pour Tacchini. Du point de vue esthétique, les formes géométriques et linéaires sont un hommage aux lignes simples et élégantes de Joaquim Tenreiro, considéré comme l'un des pères du design tropical moderne, tandis que du point de vue technique la collection Joaquim a été conçue en pensant à la récupération de déchets de fabrication, en parfaite harmonie avec les principes du surcyclage et de l'écodurabilité, pierres angulaires de la créativité brésilienne. Les tables se démarquent par une structure en métal ainsi que des plateaux et des bases en marbre Patagonie ou Elegant Brown.



Giorgio Bonaguro

Giorgio Bonaguro studied mechanical engineering in Modena and then graduated at the Scuola Politecnica di Design in Milan, in the double Master of Industrial and Interior Design. He has worked in several design studios in Milan; actually he collaborates with different companies and develops limited editions presented at some international fairs such as Design Miami/Basel, London Design Festival, Opera. He works between Italy and Brazil in the field of product design, interior design, exhibition and lighting, trying to combine a linear style with research and contamination between materials.

Other products by Giorgio Bonaguro:
Soleil (Tacchini Edizioni)

Technical informations



Low Table ⇒ p.350

Gio

Progettato nel 1957 da Gianfranco Frattini e segnalato lo stesso anno per il Compasso D'Oro, Gio è un tavolino basso che esprime un'idea di rigore razionalista e di eleganza raffinata.

Informazioni → p.289



È caratterizzato da una struttura lineare in legno e dal piano bifacciale a due colori, con tonalità più neutre o più vivaci, sempre ispirate al design anni Cinquanta. Pezzo storico del design anni '50, Gianfranco Frattini disegna il tavolino Gio nel 1957 e nello stesso anno viene segnalato per il prestigioso Compasso d'Oro. Tacchini Italia Forniture lo riedita nel 2016 e ora ne rinnova la collezione con un nuovo, raffinato, piano in finitura a effetto corno, che ne impreziosisce l'elegante rigore estetico, nel pieno rispetto dell'ambiente. La trama riprodotta rende il top lucido incredibilmente materico, sobriamente accoppiato al retro top in finitura laccato lucido, come la base. Il piano bi-facciale, caratteristico di questo oggetto d'arredo minimale e ricco di dettagli progettuali originali, acquista così una nuova declinazione di gusto, rimanendo fedele all'inconfondibile stile del modernismo italiano creato dal celebre architetto milanese.

Designer, Year:
Gianfranco Frattini, (1957) 2016



Gio (Low Table), top T113
Horn Effect, base T114 Shiny Black
W 80 D 80 H 36 cm

Costela (Armchair),
structure T121 Black → p.026



Gio (Low Table), top T68
Shiny Blue, base T49 Grey
W 80 D 80 H 36 cm

Agnese (Armchair),
base T49 Grey → p.038

→ Tacchini Edizioni: E63
(Lamp) designed by
Umberto Riva, Tarsia (Tray)
and Umbra (Rug) designed
by Maria Gabriella Zecca

Gio

Design Classic → p.002
Discover Tacchini
process of re-editions

En Designed in 1957 by Gianfranco Frattini, and nominated for the Compasso D'Oro award in the same year, Gio is a low coffee table that expresses a sense of rationalist rigour and refined elegance. It features a linear wooden frame and a two-tone reversible top, with a choice of more neutral or more lively hues, all drawn from a palette typical of fifties design. Tacchini Italia Forniture brought out a new version in 2016 and now has restyled the collection with a new and refined top in a horn effect finish which embellishes its elegant aesthetic understatement with total environmental awareness. The pattern reproduced makes the gloss top incredibly textural, discreetly coordinated with the back ingloss lacquer finish, like the base. This two-sided top, a feature of this minimalist furniture item, rich in original design details, thus gains a new dimension in taste, staying true to the unmistakable style of Italian modernism created by the renowned Milan architect.

De Gio, 1957 von Gianfranco Frattini entworfen und im gleichen Jahr für den Compasso d'Oro kandidiert, ist ein niedriger Tisch, der eine Idee von rationalistischer Strenge und raffinierter Eleganz ausdrückt. Er zeichnet sich durch eine lineare Holzstruktur aus mit beidseitig, in zwei Farben lackierter Platte, mit eher neutralen oder aber lebhaften Tönen, immer im Einklang mit den Design der fünfziger Jahre. Tacchini Italia Forniture gibt ihn 2016 wieder heraus und erneuert die Kollektion mit einer neuen, raffinierten Platte, deren Behandlung einen Horn-Effekt erzielt, um die elegante, ästhetische Strenge in vollem Umweltrespekt zu bereichern. Die so erhaltene Beschaffenheit gibt der glänzenden Platte eine effektvolle Struktur, die sich schlicht und elegant mit der glänzend lackierten Unterseite und dem Fuß in gleicher Ausführung verbindet. Die zweiseitige Platte, Charakteristik dieses minimalistischen Einrichtungsstücks voller origineller Projektdetails, wird damit zum Ausdruck einer neuen Tendenz, bleibt aber dem unverkennbaren Stil des italienischen Modernismus treu, der von dem berühmten Mailänder Architekten geschaffen wurde.

Fr La table basse Gio, dessinée en 1957 par Gianfranco Frattini et nommée la même année pour le Compasso D'Oro, exprime une idée de rigueur rationaliste et d'élégance raffinée. Elle arbore une structure linéaire en bois et un plateau double-face de deux couleurs, dans des tons neutres ou vifs, toujours inspirées du design des années 1950. Tacchini Italia Forniture, qui l'a rééditée en 2016, assortit maintenant la collection d'un nouveau plateau raffiné dont la finition effet corne embellit l'élégante rigueur esthétique, tout en respectant pleinement l'environnement. La texture reproduite rend le dessus brillant incroyablement matérielle, tandis que le dessous, sobrement couplé, arbore une finition laquée brillante à l'instar de la base. Le plateau double-face, caractéristique de ce meuble minimaliste regorgeant de détails originaux, acquiert ainsi une nouvelle déclinaison tout en restant fidèle au style incomparable du modernisme italien créé par le célèbre architecte milanais.



Gianfranco Frattini

Gianfranco Frattini was born in Padua, Italy, on 15th May, 1926. He graduated in Architecture, at the Politecnico, Milan, in 1953. At the end of the 50's, he is one of the founders of ADI, Association for Industrial Design. Frattini opened his own studio in Milan, after working in the office of his teacher and mentor Gio Ponti. In few years, he became an industrial designer, well-known worldwide. Among his many successful projects, in 1956 designed the chair model 849, nominated for the "Compasso d'Oro" Prize. Now, this armchair, which takes shapes from the original design, is proposed by Tacchini with the name of "Agnese".

Other products by Gianfranco Frattini:
Agnese → p.038, Giulia → p.044, Lina → p.032,
Oliver → Vol. A p.050, Sesann (Sofa) → Vol. A p.026,
Sesann (Armchair) → p.050

Technical informations



Low Table → p.350

Soap

Prosegue la ricerca di essenzialità di Gordon Guillaumier, che con Soap crea un tavolino dall'eleganza discreta, dalle forme morbide, gli angoli arrotondati e la liscia preziosità del top in marmo.

Informazioni → p.295



Soap (Low Table),
top T118 Shiny Patagonia
Marble, base T25
Matt Champagne Gold
W 130 D 62 H 35 cm

Soap (Low Table),
top T118 Shiny Patagonia
Marble, base T25
Matt Champagne Gold
W 54 D 54 H 54 cm

→ Tacchini Edizioni:
E63 (Lamp) designed
by Umberto Riva

Designer, Year:
Gordon Guillaumier, 2017

Soap è un tavolino dall'eleganza discreta. Le sue forme morbide, gli angoli arrotondati e la liscia preziosità del top in marmo completano con semplicità tutti i divani delle collezioni Tacchini, negli spazi del contract come in quelli domestici.

Soap (Low Table),
top T31 White Calacatta
Marble, base T25
Matt Champagne Gold
W 130 D 62 H 35 cm

Soap (Low Table),
top T31 White Calacatta
Marble, base T25
Matt Champagne Gold
W 54 D 54 H 54 cm

↪ Tacchini Edizioni: Vasum
(Vase) designed by
Maria Gabriella Zecca



Soap



Soap (Low Table), top T118
Shiny Patagonia Marble,
base T25 Matt champagne Gold
W 130 D 62 H 35 cm

Montevideo (Ottoman),
⇒ Vol. A p.056

Soap

En Gordon Guillaumier continues to explore elemental simplicity. Soap is a table with a discreet elegance. Its soft forms, rounded corners and precious, smooth, marble top complement all the sofas in the Tacchini collections with exquisite simplicity, in both contract and domestic settings.

De Die Suche von Gordon Guillaumier nach dem Wesen der Dinge geht weiter. Soap ist ein Couchtisch von dezenter Eleganz. Durch weiche Formen, gerundete Ecken und die glatte Schönheit der Marmorplatte, ist er ein schlichter Begleiter für Sofas der Kollektionen Tacchini, einsetzbar sowohl im Objektbereich wie auch im häuslichen Ambiente.

Fr La recherche d'essentialité de Gordon Guillaumier continue. Soap est une table basse à l'élégance discrète. Ses formes douces, les angles arrondis et le plateau en marbre lisse et précieux complètent avec simplicité tous les canapés des collections Tacchini, dans les espaces collectifs comme dans un intérieur domestique.



Gordon Guillaumier

Gordon Guillaumier was born in 1966, and was educated firstly in Malta, then in Switzerland, England and Italy. He graduated from IED in Milan (1988-91), before specializing in design at the Domus Academy, Milan (1992). In 1993 he began working with Baleri Associati, as well as collaborating with architect Rodolfo Dordoni. In 2002 he set up his own design studio in Milan, principally working on product design, but also for design consultancy projects. In 2006 he lectured in industrial design at Milan's Politecnico university.

Other products by Gordon Guillaumier:
Cage ⇒ p.302, Chill-Out ⇒ Vol. A p.132,
Chill-Out High ⇒ Vol. A p.140, Coot ⇒ p.308,
Face To Face ⇒ Vol. A p.044, Ledge ⇒ p.316,
Spindle ⇒ p.274

Technical informations



Low Table ⇒ p.354

Domestic, Contract

Low Table

Kelly B/O/W

Per Claesson, Koivisto e Rune, lo spirito del tempo moderno risiede proprio nel suo rapporto con il passato e nella lenta metamorfosi del suo caratteristico linguaggio formale.

Informazioni → p.301



Kelly W (Low Table),
base T61 Dark Green
W 90 D 50 H 62 cm

Kelly B (Low Table), top
T54 Grey, base T05 Grey
W 125 D 88 H 27 cm

Kelly O (Low Table),
top T55 Pink, base T17 Pink
W 50 D 34,6 H 39,5 cm

Designer, Year:
Claesson Koivisto Rune, 2014

Kelly B/O/W

Concepiti per completare le sedute della collezione Kelly, ma utilizzabili in un'infinità di situazioni, dalla casa al contract, questi tavolini con diverse altezze sono caratterizzati dalla forma piacevolmente organica del piano e dalla sottile struttura metallica, che li rende dinamici e leggeri.





Kelly W (Low Table),
base T61 Dark Green
W 90 D 50 H 62 cm

Kelly H (Armchair),
base T25 Matt Champagne
Gold ⇒ p.072

Kelly B/O/W

En Created in order to complete Kelly seating collection, but usable in every situation, from home to contract, these small tables with different heights stand out for the top's organic shape and for the thin metallic structure that make them dynamic and light.

De Entwickelt, um die Sitzmöbel der Kelly Kollektion zu ergänzen, aber in einer Vielzahl von Situationen einsetzbar, sowohl zuhause als auch im Objekt. Diese Tische mit unterschiedlichen Höhen stechen heraus durch die angenehmen organischen Formen und die dünnen Metallstruktur. Sie sind dynamisch und leicht.

Fr Conçus pour compléter les sièges de la collection Kelly, mais utilisables pour d'innombrables situations, de la maison au contract, ces petites tables de différentes hauteurs sont caractérisées par une forme organique du plateau et par une fine structure métallique qui les rend dynamiques et légères.



Claesson Koivisto Rune

The Claesson Koivisto Rune studio was established in 1995 as a multidisciplinary architecture and design workshop, in line with the classic Scandinavian tradition, but with the aim of exploring new concepts, and pursuing the values of simplicity and innovation. The three Swedes have created architectural designs throughout the world and in every sector, from homes to restaurants, retail to executive buildings, as well as furniture ranges for numerous major international firms.

Other products by Claesson Koivisto Rune: Campo (Tacchini Edizioni), Doodle (Armchair, Chaise-longue) ⇒ p.082, Doodle (Chair, Stool) ⇒ p.228, Isola ⇒ p.114, Kelly C ⇒ p.202, Kelly C Basic ⇒ p.202, Kelly E ⇒ p.072, Kelly H ⇒ p.072, Kelly L+F ⇒ p.072, Kelly S ⇒ p.072, Kelly T ⇒ p.266, Kelly V ⇒ p.210, Lima ⇒ Vol. A p.078, Misura S/M ⇒ p.150, Montevideo (Sofa, Armchair, Ottoman) ⇒ Vol. A p.056, Montevideo (Chair) ⇒ p.222, Pisa ⇒ p.100, Quartier ⇒ p.176, Santiago ⇒ Vol. A p.070, Spin ⇒ p.182, Split ⇒ p.260

Technical informations



Low Table (Kelly B/O/W) ⇒ p.351



Chair (Kelly C/C Basic/S/P) ⇒ p.342



Table (Kelly T) ⇒ p.345



Chair (Kelly V) ⇒ p.343



Armchair (Kelly E/H/L+F) ⇒ p.332

Cage

Minimalismo ed eleganza sono le caratteristiche dei tavolini Cage.

Informazioni → p.307



Designer, Year:
Godon Guillaumier, 2010

Minimalismo ed eleganza sono le caratteristiche dei tavolini Cage, in cui la base metallica è allo stesso tempo sostegno e cornice del prezioso piano in marmo. Di forma rotonda o quadrata, più alto o più basso, il tavolino Cage accompagna e completa tutti i divani e le poltrone delle collezioni Tacchini.



Cage

Cage (Low Table), top T42
Bronzed Mirror, base
T25 Matt Champagne Gold
Ø 50 H 47 cm



Cage (Low Table), top T42
Bronzed Mirror, base
T25 Matt Champagne Gold,
Ø 50 H 47 cm

Cage (Low Table), top T31 White
Calacatta Marble, base
T26 Polished Champagne Gold
Ø 100 H 32 cm

Cage

Cage (Low Table), top T32
Black Marquinia Marble,
base T28 Polished Black Chrome
Ø 100 H 32 cm

Cage (Low Table), top T41
Smoked Mirror, base
T27 Matt Black Chrome
Ø 50 H 47 cm



Cage (Low Table), top T32
Black Marquinia Marble,
base T28 Polished Black Chrome
Ø 100 H 32 cm

Cage

En Minimalism and elegance are the key features of Cage coffee tables, with their metal base that is both support and frame for the precious marble top. Cage tables can be round or square, high or low, and they accompany and complement all the sofas and armchairs in the Tacchini collections.

De Minimalismus und Eleganz sind die wichtigsten Merkmale der Couchtische Cage, die im Metallgestell gleichzeitig eine Stütze und einen Rahmen für die edle Marmorplatte haben. Von runder oder viereckiger Form, höher oder niedriger, sind Couchtische Cage die ideale Begleitung und Ergänzung für alle Sofas und Fauteuils der Kollektionen Tacchini.

Fr Minimalisme et élégance sont les caractéristiques des tables basses Cage, dont la base métallique est à la fois soutien et cadre du précieux plateau en marbre. De forme ronde ou carrée, plus haute ou plus basse, la table basse Cage accompagne et complète tous les canapés et les fauteuils des collections Tacchini.



Gordon Guillaumier

Gordon Guillaumier was born in 1966, and was educated firstly in Malta, then in Switzerland, England and Italy. He graduated from IED in Milan (1988-91), before specializing in design at the Domus Academy, Milan (1992). In 1993 he began working with Baleri Associati, as well as collaborating with architect Rodolfo Dordoni. In 2002 he set up his own design studio in Milan, principally working on product design, but also for design consultancy projects. In 2006 he lectured in industrial design at Milan's Politecnico university.

Other products by Gordon Guillaumier:
Chill-Out → Vol. A p.132, Chill-Out High → Vol. A p.140,
Coot → p.308, Face To Face → Vol. A p.044,
Ledge → p.316, Soap → p.290, Spindle → p.274

Technical informations



Low Table → p.349

Coot

Le forme della natura rappresentano una delle principali fonti di ispirazione del designer Gordon Guillaumier.

Informazioni → p.311



Coot (Low Table), top T31
White Calacatta
Marble, base T02 White
W 50 D 50 H 48,5 cm

Designer, Year:
Gordon Guillaumier, 2010

Il piano del tavolino Coot, ispirato alla pura e semplice geometria di un petalo, è un motivo perfetto per comporre una molteplicità di modelli diversi, partendo da un unico modulo. La struttura di sostegno è pensata per permettere al piano di librarsi sopra una poltrona o un divano: una funzione particolarmente utile quando si utilizza un computer portatile.



Coot (Low Table),
top T59 White, base T02 White
W 50 D 50 H 48,5 cm

Coot

En Nature's shapes represent a major source of inspiration for designer Gordon Guillaumier. The top of the Coot table was inspired by the simple geometry of a petal; it is a perfect motif for generating a variety of different models from one single form. The support structure is designed to allow the top to open up over a chair or sofa, a particularly useful feature when using a laptop computer.

De Die Naturformen stellen eine der Hauptinspirationen des Designers Gordon Guillaumier dar. Die Tischplatte des Tisches Coot, inspiriert durch die einfache und pure Geometrie eines Blütenblattes, ist ein perfektes Motiv welches auf einem einzigen Modul basiert aber die Kombination vieler verschiedener Modelle zulässt. Die Stützstruktur wurde so gedacht, dass die Tischplatte die Möglichkeit hat sich über einem Sessel oder einem Sofa zu entfalten: eine besonders nützliche Funktion, wenn man ein Notebook benutzt.

Fr Les formes de la nature représentent l'une des principales sources d'inspiration du designer Gordon Guillaumier. Le plateau de la petite table Coot s'inspire à la géométrie pure et simple d'un pétale ; c'est le motif parfait pour composer une multiplicité de modèles différents en partant d'un seul modèle. La structure de soutien est conçue afin de permettre au plateau de planer au-dessus d'un fauteuil ou d'un canapé : une fonction particulièrement utile lorsque l'on utilise un ordinateur portable.



Gordon Guillaumier

Gordon Guillaumier was born in 1966, and was educated firstly in Malta, then in Switzerland, England and Italy. He graduated from IED in Milan (1988-91), before specializing in design at the Domus Academy, Milan (1992). In 1993 he began working with Baleri Associati, as well as collaborating with architect Rodolfo Dordoni. In 2002 he set up his own design studio in Milan, principally working on product design, but also for design consultancy projects. In 2006 he lectured in industrial design at Milan's Politecnico university.

Other products by Gordon Guillaumier:
Cage ↪ p.302, Chill-Out ↪ Vol. A p.132, Chill-Out High ↪ Vol. A p.140, Face To Face ↪ Vol. A p.044,
Ledge ↪ p.316, Soap ↪ p.290, Spindle ↪ p.274

Technical informations



Low Table ↪ p.348

Polar Table

Il sistema Polar, design by Pearson Lloyd, si completa del tavolino coordinato, anch'esso ispirato agli spettacolari scenari del paesaggio glaciale, caratterizzato da linee irregolari e dolci al tempo stesso, intrinseche nella poesia della natura che ha dato loro forma.

Informazioni → p.315

Designer, Year:
PearsonLloyd, 2007

Polar Table è un tavolino pensato per spazi interni ed esterni, dalla forma originale e inedita, che permette di giocare e scegliere il lato d'appoggio, grazie a base e piano alternabili nella funzione, a seconda del lato che si sceglie di tenere verso l'alto o verso il basso. Un elemento perfetto da inserire nel sistema di divani Polar, ma anche da accostare ad altri arredi, in molteplici contesti.





Polar Table (Low Table),
finish T21 White
W 49 D 41 H 43 cm

Polar Table

En A matching side table completes the Polar system. Also designed by Pearson Lloyd and inspired by spectacular glacier formations, it features asymmetrical yet delicate lines, inherent to the poetry of the natural setting from which its shape derives. The Polar Table is an occasional table for both interior and exterior spaces. Thanks to its fresh, unique shape, it can be placed with either end up, which also changes its functional options. The ideal piece to pair with the Polar sofa system, it also marries well with other furnishings in many different settings.

De Zum System Polar des Designers PearsonLloyd gehört auch ein passender Couchtisch, der sich ebenfalls an den spektakulären Szenarien der Eislandschaft inspiriert und durch die unregelmäßigen und zugleich sanften Linien charakterisiert ist, in denen die Poesie der Natur zum Ausdruck kommt, die ihnen ihre Form gegeben hat. Polar Table ist ein Couchtisch für Innenräume und Außenbereiche mit originaler und innovativer Form. Der Tisch lässt sich auf den Kopf stellen und beide Seiten können beliebig als Fuß oder als Tischplatte verwendet werden. Ein Element, das sich perfekt in das System der Sofas Polar einfügt, das aber auch zu anderen Einrichtungen in den unterschiedlichsten Umgebungen passt.

Fr Le système Polar, dessiné par PearsonLloyd, comprend également une petite table assortie, inspirée elle aussi des scénarios spectaculaires du paysage glaciaire et caractérisée par des lignes à la fois douces et irrégulières, intrinsèques à la poésie de la nature qui leur a donné forme. Conçue pour les espaces intérieurs et extérieurs, la table basse Polar possède une forme originale et inédite permettant de jouer et de choisir quel côté sera la base ou le plateau, puisque les deux faces peuvent alternativement revêtir les deux fonctions ; il suffit pour cela de la poser sur l'une ou l'autre face. Cet élément s'intègre parfaitement dans le système de canapé Polar, mais peut également être combiné avec d'autres meubles, dans de multiples contextes.



PearsonLloyd

PearsonLloyd is one of the leading names in contemporary British design, and this multidisciplinary studio works in a wide range of sectors: from furnishing to public spaces to brand development. Established by Luke Pearson and Tom Lloyd in 1997, the studio has received numerous acknowledgements and accolades in both Europe and the United States. The British design duo write regularly for major design magazines, as well as acting as "visiting lecturers" at the École Cantonale d'Art in Lausanne.

Other products by PearsonLloyd:
Crystal (Sofa) ↪ Vol. A p.098, Crystal (Armchair) ↪ p.108, Eddy ↪ p.240, Fixie ↪ p.252, Galleria ↪ Vol. A p.148, Ischia ↪ Vol. A p.124, Nebula (Tacchini Edizioni), Polar ↪ Vol. A p.162, Polar Perch ↪ Vol. A p.170, Quilt ↪ Vol. A p.062, Stone High/Low ↪ Vol. A p.180

Technical informations

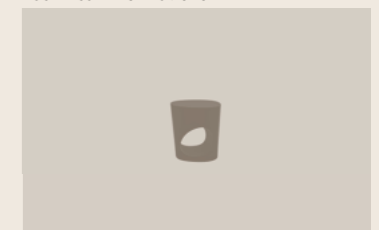

Low Table ↪ p.353

Ledge

Un accessorio multiuso per un'infinità di esigenze e situazioni: dal lavoro, alla lettura, all'aperitivo.

Informazioni → p.319



Ledge (Low Table),
top T35 Matt Basaltina
Marble, base T02 White
W 28 D 52 H 56 cm

Chill-Out High (Modular
System), base T02
White → Vol. A p.140

Designer, Year:
Gordon Guillaumier, 2016

Progettato come complemento per i divani del sistema modulare Chill-Out, dei quali riprende le linee essenziali, Ledge è un piccolo tavolino con una struttura metallica laterale che dona leggerezza e stabilità. Per le finiture delicate e preziose, Ledge si presta non soltanto a essere usato in ambito contract, ma anche dentro spazi domestici.



Ledge (Low Table),
top T31 White Calacatta Marble,
base T24 Satin Chrome
W 28 D 52 H 56 cm

Chill-Out High (Modular
System), base T24 Satin Chrome
⇒ Vol. A p.140

Ledge

En Designed to complement the sofas in the modular system Chill-Out, and echoing their essential lines, Ledge is a small coffee table with an offset metal frame that offers lightness and stability. With its delicate and precious finishes, it is suitable for use not only in the contract world, but also at home.

De Ledge, ursprünglich als Zubehör für modulare Sitzlandschaften Chill-Out im gleichen, schlichten Design entwickelt, ist ein kleines seitlich ausladendes Tischchen, dem eine metallische Querstruktur Stabilität verleiht. Ein Kleinmöbel für vielseitige Bedürfnisse und Gelegenheiten: am Arbeitsplatz, für die Leseecke, zum Aperitif.

Fr Conçue comme complément pour les canapés du système modulaire Chill-Out, dont elle reprend les lignes essentielles, Ledge est une petite table d'appoint latérale en porte-à-faux, avec une structure métallique transversale qui lui donne sa stabilité. Un accessoire multifonction pour les exigences et les situations les plus variées : du travail, à la lecture, à l'apéritif.



Gordon Guillaumier

Gordon Guillaumier was born in 1966, and was educated firstly in Malta, then in Switzerland, England and Italy. He graduated from IED in Milan (1988-91), before specializing in design at the Domus Academy, Milan (1992). In 1993 he began working with Baleri Associati, as well as collaborating with architect Rodolfo Dordoni. In 2002 he set up his own design studio in Milan, principally working on product design, but also for design consultancy projects. In 2006 he lectured in industrial design at Milan's Politecnico university.

Other products by Gordon Guillaumier:
Cage ⇒ p.302, Chill-Out ⇒ Vol. A p.132, Chill-Out High ⇒ Vol. A p.140, Coot ⇒ p.308, Face To Face ⇒ Vol. A p.044, Soap ⇒ p.290, Spindle ⇒ p.274

Technical informations



Low Table ⇒ p.352

Domestic, Contract

Low Table

Labanca Table

L'unicità preziosa di un'idea trasferisce la sua intrinseca natura alla materia, formandola a sua immagine.

Informazioni → p.323



Labanca Table, design Lievore Altherr Molina, è il tavolino realizzato con un'unica lastra di cristallo, curvata e verniciata. Oggetto essenziale d'ispirazione fortemente moderna, il tavolino Labanca, complemento anche della collezione di divani che porta lo stesso nome, declina la purezza del cristallo in una forma geometrica multifunzionale, estremamente adattabile a vari spazi dell'ambiente domestico e dei contesti contract. La verniciatura esterna dei piani è in finitura lucida, a contrasto con quella interna, in finitura opaca.

Designer, Year:
Lievore Altherr Molina, 2004



Labanca Table

Labanca Table (Low Table),
finish Black Rear Painted Glass
W 66 D 66 H 36 cm

Pisa (Armchair)
→ p.100



Labanca Table (Low Table),
finish White Rear Painted Glass
W 66 D 66 H 36 cm

Labanca (Armchair)
⇒ Vol. A p.104

Labanca Table

En The priceless singularity of an idea infuses its intrinsic nature into the material, molding it in its image. Designed by Lievore Altherr Molina, the Labanca side/accent table is made from a single sheet of curved and painted glass. Thoroughly modern and minimalist-inspired, the Labanca table, companion piece to the eponymous collection of sofas, interprets the purity of glass through an extremely versatile, multi-functional geometric shape, suited to domestic and contract settings. Exterior finish of the surfaces is glossy, while the inner surfaces have a matte finish.

De Die Einzigartigkeit einer Idee, deren Charakter auf die Materie übertragen wird und diese nach ihrem Abbild formt. Der Labanca Table vom Designer Lievore Altherr Molina besteht aus einer einzigen, gebogenen und lackierten Glasplatte. Der minimalistische Couchtisch Labanca mit deutlich moderner Inspiration ist Teil der gleichnamigen Sofakollektion und bringt die Reinheit von Glas in eine multifunktionelle geometrische Form, die sich extrem gut an die verschiedenen Wohnräume und Objekteinrichtungen anpasst. Die Außenseite mit einer Hochglanzlackierung bildet einen eleganten Kontrast zur Innenseite mit matter Lackierung.

Fr Une idée unique et précieuse qui transfère sa nature intrinsèque à la matière, en la modelant à son image. Labanca Table, signée par Lievore Altherr Molina, est une table basse réalisée à partir d'une unique plaque de verre courbée et peinte. Objet minimaliste d'inspiration résolument moderne et complément de la collection de canapés du même nom, la table basse Labanca décline la pureté du verre en une forme géométrique multifonctionnelle qui s'adapte parfaitement à différents espaces domestiques et du secteur contract. La peinture externe des plateaux arbore une finition brillante qui contraste avec la finition mate de l'intérieur.



Lievore Altherr Molina

Born in 1948, Alberto Lievore studied architecture in Buenos Aires. In the early years he focused not only on design, but also on the production and marketing of furniture, then, having moved to Barcelona, he was part of the Grupo Berenguer (1977), a leading name in Spanish design. In 1984 he inaugurated his own studio, focusing on industrial design, and on consultancy and art direction for a number of firms. His partners are designer and stylist Jeannette Altherr, who specializes in objects and spaces for children, and Manel Molina, who again brings with him vast and varied experiences in the industrial and exhibition design sectors.

Other products by Lievore Altherr Molina:
Baobab ⇒ p.126, Girola ⇒ p.166, Havana ⇒ Vol. A p.118,
Labanca ⇒ Vol. A p.104, Nara ⇒ p.324

Technical informations



Labanca Table ⇒ p.352

Nara

Nara è una collezione di tavolini contraddistinti dalla geometrica purezza dei volumi.

Informazioni → p.327

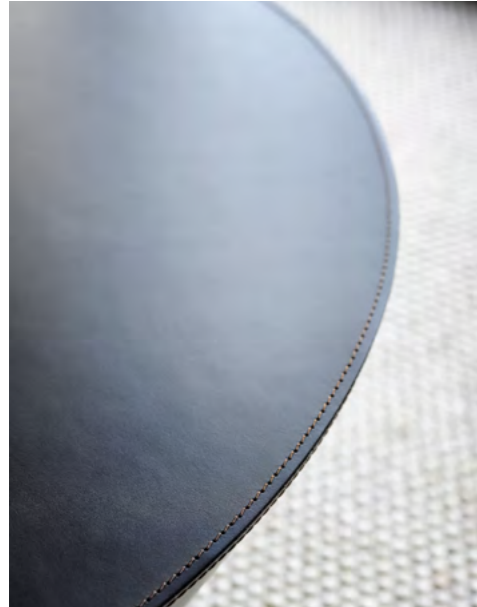

Designer, Year:
Lievore Altherr Molina, 2005

Due le dimensioni per due forme diverse, quadrata e tonda. Totalmente rivestiti in cuoio, i tavolini Nara sono una presenza calda ed essenziale nella zona giorno accanto ai divani e in ogni altra stanza della casa.

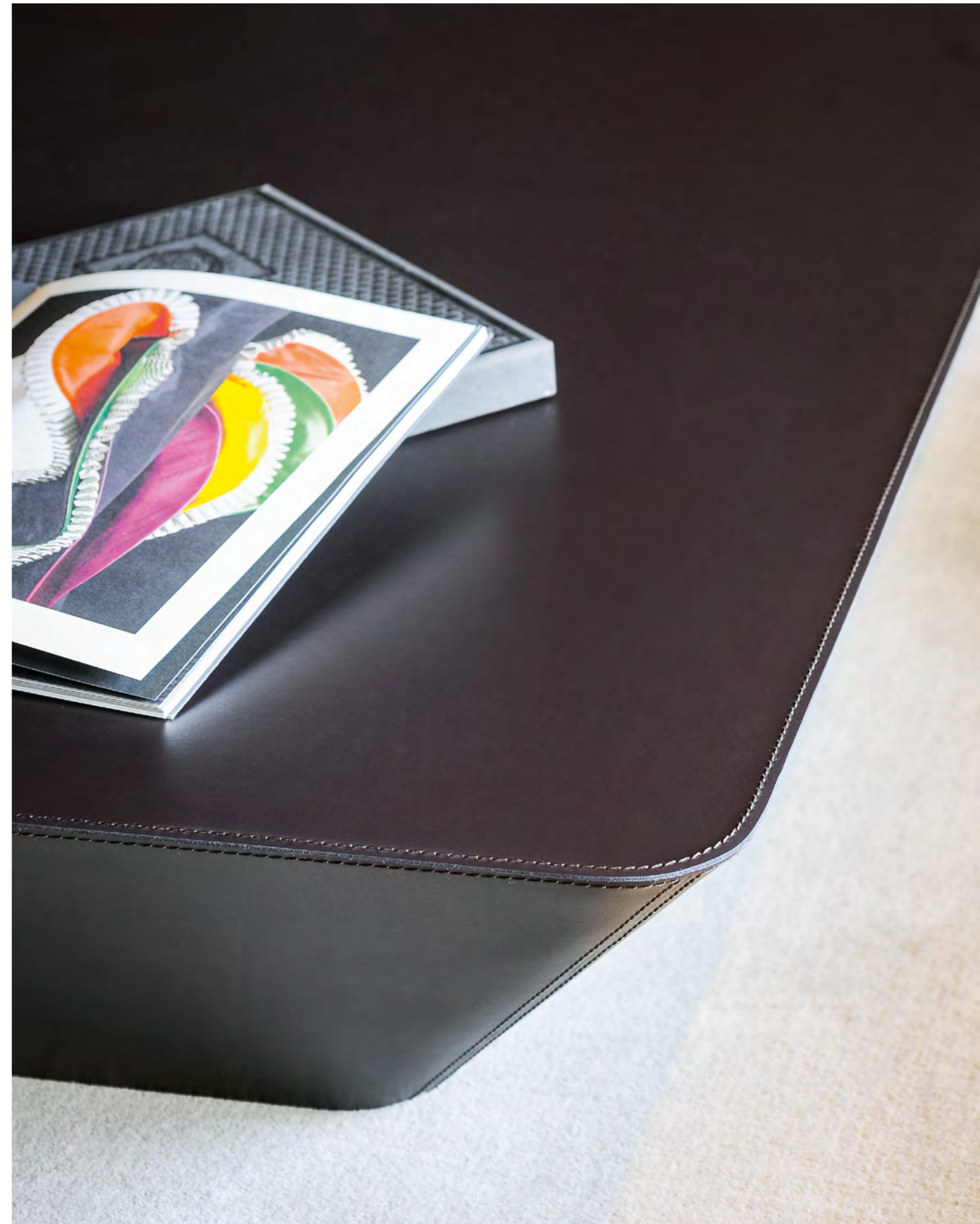



Nara

En Nara is a collection of coffee tables featuring shapes of a remarkable geometric purity. It comes in two shapes, round and square, with two sizes for each. Covered entirely in leather, Nara coffee tables introduce a warm, essential presence alongside sofas in the living area, and in any other part of the home.

De Nara ist eine Kollektion von Couchtischen, die sich durch geometrisch klare Volumen auszeichnet. Zwei Größen für zwei verschiedene Formen, quadratisch und rund. Die vollständig mit Leder bezogenen Tischchen Nara sind eine warme, essentielle Begleitung des Sofas im Wohnbereich und in jedem anderen häuslichen Raum.

Fr Nara est une collection de tables basses caractérisées par la pureté géométrique des volumes. Elles existent en deux dimensions pour deux formes différentes, carrée et ronde. Entièrement recouvertes de cuir, les tables basses Nara sont une présence chaude et essentielle dans un living, à côté des canapés, et dans n'importe quelle autre pièce de la maison.



Lievore Altherr Molina

Born in 1948, Alberto Lievore studied architecture in Buenos Aires. In the early years he focused not only on design, but also on the production and marketing of furniture, then, having moved to Barcelona, he was part of the Grupo Berenguer (1977), a leading name in Spanish design. In 1984 he inaugurated his own studio, focusing on industrial design, and on consultancy and art direction for a number of firms. His partners are designer and stylist Jeannette Altherr, who specializes in objects and spaces for children, and Manel Molina, who again brings with him vast and varied experiences in the industrial and exhibition design sectors.

Other products by Lievore Altherr Molina:
Baobab → p.126, Girola → p.166, Havana → Vol. A p.118,
Labanca → Vol. A p.104, Labanca Table → p.320

Technical informations



Labanca Table → p.353

Nara (Low Table)
W 109 D 109 H 25 cm
Ø 110 H 26 cm

Baobab (Armchair)
→ p.126

→ Tacchini Edizioni: Campo
(Rug) designed by
Claesson Koivisto Rune

Più che di grandi rivoluzioni, il design contemporaneo è fatto di piccoli cambiamenti e di lente, pazienti mutazioni del linguaggio visivo che trasforma anche le cose più banali in oggetti straordinari. Il carattere unico e irripetibile degli oggetti di design nasce da queste silenziose rivoluzioni che trasformano forme familiari, usuali e riconoscibili in progetti iconici che catturano lo spirito del proprio tempo.

Technical Informations

More than great revolutions, contemporary design is made of small changes and slow patient mutations of visual language, which changes even the most mundane things in extraordinary objects. The unique character of design objects results from these silent revolutions that transform familiar usual and recognizable forms into iconic projects that capture the spirit of their time.

| | | | | |
|---------------------------------------------------------------------------------------|--------------------------------------------------------------------------------------------------------------------------------|--------------------------------------------------------------------------------------------------------------------------|---------------------------------------------------------------------------------------------------|--------------------------------------------------------------------------------------------------|
| Agnese | by Gianfranco Frattini | Armchair, Ottoman | → Design Classic | Non-removable covers Not feasible in vinyl |
|  |  | | | |
| OAGN84 W 84 D 76 H 73 cm Seat H 44 cm | OAGNP57 W 57 D 51 H 42 cm Seat H 42 cm | | | |
| |  |  | | |
| | T43 | T49 | | |
| Base Base Gestell Piétement | Noce Scuro Dark Walnut Dunkel Walnuss Noyer Foncé | Tinto Grigio Grey Grau Gris | | |
| Baobab | by Lievore Altherr Molina | Armchair | | Non-removable covers |
|  | | | | |
| OBAO80 W 80 D 77 H 69 cm Seat H 40 cm | Base Su ruote With wheels Mit Rollen Avec roulettes | | | |
| Costela | by Martin Eisler | Armchair, Ottoman | → Design Classic | Non-removable covers |
|  |  | | | |
| OCOS74 W 74 D 80 H 83 cm Seat H 40 cm | OCOSP74 W 74 D 55 H 40 cm Seat H 40 cm | | | |
| |  |  | | |
| | T115 | T121 | | |
| Base Base Gestell Piétement | Tinto Noce Poro Aperto Open Pore Stained Walnut Gebeizt Nussbaum mit offenen Poren Teinté Noyer à Pores Ouverts | Tinto Nero Poro Aperto Open Pore Stained Black Gebeizt Schwarz mit offenen Poren Teinté Noir à Pores Ouverts | | |
| Crystal | by PearsonLloyd | Armchair, Sofa | | Non-removable covers |
|  |  |  | | |
| OCRY96/OCRYG96 W 96 D 80 H 68 cm Seat H 43 cm | OCRY153 W 153 D 85 H 68 cm Seat H 46 cm | OCRY213 W 213 D 85 H 68 cm Seat H 46 cm | Base Base fissa (OCRY96) o girevole (OCRYG96) Fixed (OCRY96) or swivel (OCRYG96) base | Mit fixer (OCRY96) oder Drehgestell (OCRYG96) Base fixe (OCRY96) ou pivotante (OCRYG96) |

Dot by Patrick Norguet Armchair Non-removable covers
Not feasible in vinyl



ODOT87
W 87 D 81 H 92 cm
Seat H 42 cm



T02

RAL 9016

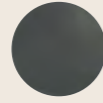

T04

RAL 7022



T07

RAL 9011



T08

RAL 8019

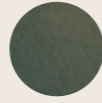

T61

RAL 6014

Base metallo
Metal base
Metallgestell
Piétement en métal

Bianco
White
Weiss
Blanc

Grigio
Grey
Grau
Gris

Nero
Black
Schwarz
Noir

Marrone
Brown
Braun
Brun

Verde Scuro
Dark Green
Dunkelgrün
Vert Foncé

Girola by Lievore Altherr Molina Armchair Non-removable covers



OGIR87
W 87 D 74 H 64 cm
Seat H 40 cm

Base

Base girevole
Swivel base
Drehgestell
Base pivotante

Giulia by Gianfranco Frattini Armchair, Ottoman ↪ Design Classic Non-removable covers



OGIU86
W 86 D 95 H 104 cm
Seat H 43 cm



OGIUP57
W 57 D 51 H 42 cm
Seat H 42 cm



T43



T49

Base
Base
Gestell
Piétement

Noce Scuro
Dark Walnut
Dunkel Walnuss
Noyer Foncé

Tinto Grigio
Grey
Grau
Gris

Glide by Monica Förster Armchair Non-removable covers
Not feasible in vinyl

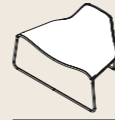

OGLI106
W 106 D 65 H 61 cm
Seat H 37 cm



T02

RAL 9016



T07

RAL 9011



T08

RAL 8019



T16

RAL 5003

Base verniciata
Painted base
Gestell lackiert
Piétement laqué

Bianco
White
Weiss
Blanc

Nero
Black
Schwarz
Noir

Marrone
Brown
Braun
Brun

Blu
Blue
Blau
Bleu

Isola by Claesson Koivisto Rune Armchair Non-removable covers



OIS118T
W 118 D 86,5 H 85 cm
Seat H 40 cm
Table H 57,5 cm



OIS118
W 118 D 86,5 H 85 cm
Seat H 40 cm



T02

RAL 9016

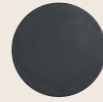

T03

RAL 7016



T07

RAL 9011



T08

RAL 8019

Base verniciata
Painted base
Gestell lackiert
Piétement laqué

Bianco
White
Weiss
Blanc

Grigio
Grey
Grau
Gris

Nero
Black
Schwarz
Noir

Marrone
Brown
Braun
Brun



T24

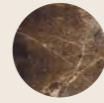

T33



T34

Base cromata
Chromed base
Gestell verchromt
Piétement chromé



Cromo Satinato
Satin Chromed
Satinert Verchromt
Chrome Satiné





Tavolino marmo
Little marble table
Marmortisch
Table de marbre

Black Travertino Opaco
Matt Black Travertine
Matt Schwarz Travertino
Noir Travertino Mat

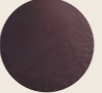



Biancane Lucido
Shiny Biancane
Biancane Glänzend
Biancane Brillant

| | | | |
|----------------------------------------------------------------------------------|--------------------|----------|------------------|
| Jacket | by Patrick Norguet | Armchair | Removable covers |
|  | | | |
| OJACK86 W 89 D 80 H 79 cm Seat H 42 cm | | | |

| | | | |
|-----------------------------------------------------------------------------------|-----------------------------------------------------------------------------------|-----------------------------------------------------------------------------------|-------------------------------------------------------------------------------------|
|  |  |  |  |
| T02 RAL 9016 | T04 RAL 7022 | T07 RAL 9011 | T13 RAL 3005 |
| Base verniciata Painted base Gestell lackiert Piétement laqué | Bianco White Weiss Blanc | Grigio Grey Grau Gris | Nero Black Schwarz Noir |
| | | Bordeaux Bordeaux Bordeaux Bordeaux | |

| | | | |
|----------------------------------------------------------------------------------|-----------------------------------------------------------------------------------|-----------------------------------------------------------------------------------|-----------------------------------------------------------------------------------|
| Kelly E/H/L+F | by Claesson Koivisto Rune | Armchair, Chaise-longue | Non-removable covers |
|  |  |  |  |
| KELLY E OKELE70 W 70 D 80 H 81 cm Seat H 39,6 cm | KELLY H OKELEH104 W 104 D 78 H 126 cm Seat H 43 cm | KELLY L OKELEL104 W 104 D 116 H 84 cm Seat H 36 cm | KELLY F OKELEF104 W 104 D 49,5 H 41 cm Seat H 36 cm |

| | | | | |
|-------------------------------------------------------------------------------------|-------------------------------------------------------------------------------------|-------------------------------------------------------------------------------------|---------------------------------------------------------------------------------------|---------------------------------------------------------------------------------------|
|  |  |  |  |  |
| T02 RAL 9016 | T04 RAL 7022 | T05 RAL 7023 | T07 RAL 9011 | T09 RAL 1003 |
| Base verniciata Painted base Gestell lackiert Piétement laqué | Bianco White Weiss Blanc | Grigio Grey Grau Gris | Grigio cemento Concrete Grey Betongrau Gris Béton | Nero Black Schwarz Noir |
| | | | | Giallo Yellow Gelb Jaune |



| | | | | | |
|------------------------------------------------------------------------------------|-------------------------------------------------------------------------------------|-------------------------------------------------------------------------------------|-------------------------------------------------------------------------------------|---------------------------------------------------------------------------------------|---------------------------------------------------------------------------------------|
|  |  |  |  |  |  |
| T10 RAL 2004 | T12 RAL 3000 | T15 RAL 6034 | T17 RAL 3014 | T18 RAL 6029 | T19 RAL 5021 |
| Arancio Orange Orange Orange | Rosso Red Rot Rouge | Turchese Turquoise Türkis Turquoise | Rosa Pink Rosa Rose | Verde Green Grün Vert | Blu Petrolio Petrol Blue Petroleum Blau Bleu Pétrole |

| | | |
|------------------------------------------------------------------------------------|-------------------------------------------------------------------------------------|------------------------------------------------------------------------------------------|
|  |  |  |
| T61 RAL 6014 | T25 | T64 |
| Verde Scuro Dark Green Dunkelgrün Vert Foncé | Base cromata Chromed base Gestell verchromt Piétement chromé | Oro Champagne Opaco Matt Champagne Gold Matt Champagne Gold Or Champagne Mat |
| | | Rame Spazzolato Opaco Brush Matt Copper Matt Gebürstet Kupfer Brossé Mat Cuivre |



| | | | |
|-------------------------------------------------------------------------------------|---------------------|----------|----------------------|
| Lagoa | by Zanini De Zanine | Armchair | Non-removable covers |
|  | | | |
| OLAG90 W 90 D 74 H 78 cm Seat H 33 cm | | | |

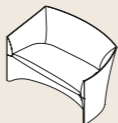

| | | | | |
|-------------------------------------------------------------------------------------|------------------------|----------|----------------|----------------------|
| Lina | by Gianfranco Frattini | Armchair | Design Classic | Non-removable covers |
|  | | | | |
| OLIN78 W 78 D 78 H 76 cm Seat H 41 cm | | | | |



| | |
|-------------------------------------------------------------------------------------|-------------------------------------------------------------------------------------|
|  |  |
| T43 | T49 |
| Base Base Gestell Piétement | Noce Scuro Dark Walnut Dunkel Walnuss Noyer Foncé |
| | Tinto Grigio Grey Grau Gris |





| | | | |
|---------------------------------------------------------------------------------------|---------------------------------------------------------------------------------------|---------------------------------------------------------------------------------------|----------------------|
| Mayfair | by Christophe Pillet | Armchair, Sofa, Chair | Non-removable covers |
|  |  |  | |
| OMAY64 W 64 D 69 H 82 cm Seat H 44 cm | OMAY131 W 131 D 74 H 82 cm Seat H 44 cm | OMAY57 W 57 D 56 H 80 cm Seat H 45,5 cm | |

| | | | |
|------------------------------------------------------------------------------------------|---------------------------------------------------------------------------------------|---------------------------------------------------------------------------------------|---------------------------------------------------------------------------------------|
|  |  |  |  |
| T02 RAL 9016 | T07 RAL 9011 | T08 RAL 8019 | T94 |
| Only for OMA57 Base verniciata Painted base Gestell lackiert Piétement laqué | Bianco White Weiss Blanc | Nero Black Schwarz Noir | Marrone Brown Braun Brun |
| | | | Bronzo Bronze Bronze Bronze |



| | | | |
|----------------------------------------------------------------------------------|-----------------------------------------------------------------------------------|---------------------------------------------------------------------------------------------|------------------------------------------------------------------------------------------------------------|
| Misura S/M | by Claesson Koivisto Rune | Armchair | Non-removable covers |
|  |  | Misura S Piedini (OMIS61P) o ruote (OMIS61R) Feet (OMIS61P) or wheels (OMIS61R) | Misura M Piedini (OMIM76P) o base girevole (OMIM76B) Feet (OMIM76P) or swivel base (OMIM76B) |
| OMIS61P/OMIS61R W 61 D 66 H 77 cm Seat H 46 cm | OMIM76P/OMIM76B W 76 D 70 H 77 cm Seat H 42 cm | Füße (OMIS61P) oder Rollen (OMIS61R) Patins (OMIS61P) ou roulettes (OMIS61R) | Füßen (OMIM76P) oder Drehgestell (OMIM76B) Patins (OMIM76P) ou base pivotante (OMIM76B) |

| | | | |
|----------------------------------------------------------------------------------|-----------------------------------------------------------------------------------|-----------------------------------------------------------------|---------------------------------|
| Moon | by Pietro Arosio | Armchair | Non-removable covers |
|  | | | |
| OMO183 W 83,5 D 73 H 89 cm Seat H 38 cm | Base girevole Swivel base Drehgestell Base pivotante | | |
| |  | | |
| | T20 RAL 9005 T21 RAL 9003 T95 RAL 7006 | | |
| Scocca esterna Shell Gestell Coque | Nero Lucido Gloss Black Schwarz Glänzend Noir Brillant | Bianco Lucido Gloss White Weiß Glänzend Blanc Brillant | Fango Mud Schlamm Boue |





| | | | |
|------------------------------------------------------------------------------------|-------------------------------------------------------------------------------------|-------------------------------------|----------------------|
| Parentesi | by Pietro Arosio | Armchair | Non-removable covers |
|  | | | |
| OPAA80/OPAT80 W 80 D 65 H 75 cm Seat H 45 cm | | | |
| |  | | |
| Schienale poltrona Armchair backrest Rücklehne Sessel Dossier fauteuil | Imbottito Upholstered Gepolstert Rembourré | Alluminio Aluminium Aluminium | |

| | | | |
|-------------------------------------------------------------------------------------|-------------------------------------------------------------------------------------|-------------------------------------------------------------------------------------|-------------------------------------------------------------------------------------|
| Pastilles | by Studioepepe | Armchair, Pouf, Low Table | Non-removable covers |
|  |  |  |  |
| OPAS57 W 57 D 55 H 73 cm Seduta H 47 cm | OPASP57 W 57 D 55 H 47 cm Seduta H 47 cm | 1PAS50 Ø 50 H 43 cm | 1PAS100 Ø 100 H 33 cm |

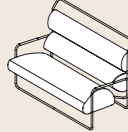
| | | | |
|----------------------------------------|-------------------------------------------------------------------------------------|-------------------------------------------------------------------------------------------------------|---------------------------------------------------------------------------------------------------|
| |  | | |
| Base Base Gestell Piétement | Alluminio Lucido Gloss Aluminium Aluminium Glänzend Aluminium Brillant | Nero Lucido Gloss Black Schwarz Glänzend Noir Brillant | Nero Opaco Matt Black Matt Schwarz Noir Mat |
| | T29 | T32 | T33 |
| Piano Top Tischplatte Plateau | Carrara Lucido Shiny White Carrara Carrara Glänzend Carrara Brillant | Marquinia Lucido Shiny Black Marquinia Schwarz Marquinia Glänzend Noir Marquinia Brillant | Black Travertino Opaco Matt Black Travertine Matt Schwarz Travertino Noir Travertino Mat |

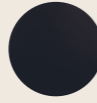
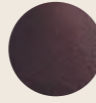

| | | | |
|---------------------------------------------------------------------------------------|-----------------------------------------------------------------------------------------------------------------|---------------------------------------------------------------------------------------------------|---------------------------------------|
| Pisa | by Claesson Koivisto Rune | Armchair | Non-removable covers |
|  | | | |
| OPIS67P/OPIS67G W 67 D 76 H 82 cm Seat H 45 cm | Piedini Feet Piedini (OPIS67P) o base girevole (OPIS67G) Feet (OPIS67P) or swivel base (OPIS67G) | Füßen (OPIS67P) oder Drehgestell (OPIS67G) Patins (OPIS67P) ou base pivotante (OPIS67G) | |
| Reversível | by Martin Eisler | Armchair | ⇒ Design Classic Non-removable covers |
|  | | | |
| OREV104 W 104 D 73 H 68 cm Seduta H 34 cm | | | |

| | | | | |
|----------------------------------------------------------------------------------|-----------------------------------------------------------------------------------|-----------------------|------------------|-------------------------------------|
| Sancarlo | by Achille Castiglioni | Armchair, Sofa | → Design Classic | Removable fabric and leather covers |
|  |  | | | |
| OSAN62 W 62,5 D 92 H 118 cm Seat H 45 cm | OSAN124 W 124 D 83,5 H 92 cm Seat H 45 cm | | | |

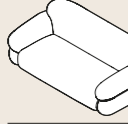
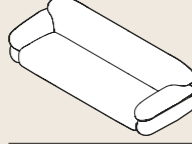

| | | | | | | | |
|-----------------------------------------------------------------------------------|-----------------------------------------------------------------------------------|-----------------------------------------------------------------------------------|-------------------------------------------------------------------------------------|-------------------------------------------------------------------------------------|-------------------------------------------------------------------------------------|-------------------------------------------------------------------------------------|-------------------------------------------------------------------------------------|
|  |  |  |  |  |  |  |  |
| T02 | RAL 9016 | T06 | RAL 7043 | T07 | RAL 9011 | T13 | RAL 3005 |
| Struttura verniciata Painted structure Gestell lackiert Piétement laqué | Bianco White Weiss Blanc | Grigio Grey Grau Gris | Nero Black Schwarz Noir | Bordeaux Bordeaux Bordeaux Bordeaux | | | |

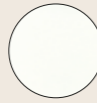

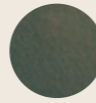

| | | | | |
|----------------------------------------------------------------------------------|-----------------------------------------------------------------------------------|-----------------------------------------------------------------------------------|------------------|----------------------|
| Sesann | by Gianfranco Frattini | Sofa, Armchair | → Design Classic | Non-removable covers |
|  |  |  | | |
| OSES110 W 110 D 94 H 67 cm Seat H 38 cm | OSES180 W 180 D 94 H 67 cm Seat H 38 cm | OSES240 W 240 D 94 H 67 cm Seat H 38 cm | | |

| | | | | | |
|-------------------------------------------------------------------------------------|-------------------------------------------------------------------------------------|-------------------------------------------------------------------------------------|---------------------------------------------------------------------------------------|---------------------------------------------------------------------------------------|-----------------------------------------------------------------------------------------|
|  |  |  |  |  | |
| T23 | T24 | T25 | T27 | T28 | |
| Struttura cromata Chromed structure Gestell verchromt Piétement chromé | Cromo Lucido Polished Chromed Poliert Verchromt Chrome Brillant | Cromo Satinato Satin Chrome Satinert Verchromt Chrome Satiné | Oro Champagne Opaco Matt Champagne Gold Matt Champagne Gold Or Champagne Mat | Cromo Nero Opaco Matt Black Chromed Matt Schwarz Verchromt Chrome Noir Mat | Cromo Nero Lucido Polished Black Chromed Schwarz-Glänzend Chrome Noir Brillant |

| | | | | | |
|------------------------------------------------------------------------------------------|-------------------------------------------------------------------------------------|-------------------------------------------------------------------------------------|---------------------------------------------------------------------------------------|---------------------------------------------------------------------------------------|-------------------------------------------------------|
|  |  |  |  |  | |
| T64 | T02 | T07 | T11 | T61 | |
| Rame Spazzolato Opaco Brush Matt Copper Matt Gebürstet Kupfer Brossé Mat Cuivre | Struttura verniciata Painted structure Gestell lackiert Piétement laqué | Bianco White Weiss Blanc | Nero Black Schwarz Noir | Arancio Orange Orange Orange | Verde Scuro Dark Green Dunkelgrün Vert Foncé |

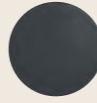
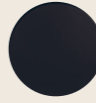

| | | |
|-------------------------------------------------------------------------------------|-------------------------------------------------------------------------------------|--------------------------------------|
|  |  | |
| T43 | T49 | |
| Piedini Feet Füßen Patins | Noce Scuro Dark Walnut Dunkel Walnuss Noyer Foncé | Tinto Grigio Grey Grau Gris |

| | | | |
|-------------------------------------------------------------------------------------|-------------------------------------------------------------------------------------|---------------------------------------------------------------|-----------------------------------------------|
| Shelter | by Noé Duchaufour-Lawrance | Armchair, Ottoman | Non-removable covers Not feasible in vinyl |
|  |  | | |
| OSHE69 W 69,5 D 85 H 114,5 cm Seat H 41 cm | OSHE60 W 60 D 51 H 41 cm Seat H 41 cm | Base girevole Swivel base Drehgestell Base pivotante | |

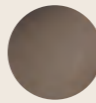
| | | | | | | | |
|-------------------------------------------------------------------------------------|-------------------------------------------------------------------------------------|-------------------------------------------------------------------------------------|-------------------------------------------------------------------------------------|-------------------------------------------------------------------------------------|-------------------------------------------------------------------------------------|-------------------------------------------------------------------------------------|-------------------------------------------------------------------------------------|
|  |  |  |  |  |  | | |
| T02 | RAL 9016 | T03 | RAL 7016 | T07 | RAL 9011 | T08 | RAL 8019 |
| Base verniciata Painted base Gestell lackiert Piétement laqué | Bianco White Weiss Blanc | Grigio Grey Grau Gris | Nero Black Schwarz Noir | Marrone Brown Braun Brun | | | |

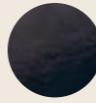

| | |
|-------------------------------------------------------------------------------------|-------------------------------------------------------------------------------------|
|  | |
| T27 | |
| Base cromata Chromed base Gestell verchromt Piétement chromé | Cromo Nero Opaco Matt Black Chromed Matt Schwarz Verchromt Chrome Noir Mat |



| | | | |
|---------------------------------------------------------------------------------------|-----------------------------|-----------------|----------------------|
| SouthBeach | by Christophe Pillet | Armchair | Non-removable covers |
|  | | | |
| OSOUL110 W 110 D 68 H 139 cm Seat H 43 cm | | | |



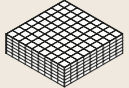

| | | | | | |
|---------------------------------------------------------------------------------------|---------------------------------------------------------------------------------------|---------------------------------------------------------------------------------------|---------------------------------------------------------------------------------------|---------------------------------------------------------------------------------------|-----------------------------------|
|  |  |  |  |  | |
| T20 | T21 | T51 | T52 | Faggio | |
| Struttura Structure Struktur Structure | Nero Lucido Gloss Black Schwarz Glänzend Noir Brillant | Bianco Lucido Gloss White Weiß Glänzend Blanc Brillant | Bianco Opaco White Mat Weiß Matt Blanc Mat | Nero Opaco Black Mat Schwarz Matt Noir Mat | Faggio Beech Buche Hetre |

| | | | |
|----------------------------------------------------------------------------------|------------------|----------|----------------------|
| XL | by Pietro Arosio | Armchair | Non-removable covers |
|  | | | |
| <p>OXLTE80 W 80 D 71 H 71 cm Seat H 35 cm</p> | | | |



| | | | |
|-----------------------------------------------------------------------------------|-----|------------------------------------------------------------------------------------|--|
|  | T23 | | |
| <p>Base cromata Chromed base Gestell verchromt Piétement chromé</p> | | <p>Cromo Lucido Polished Chromed Poliert Verchromt Chrome Brillant</p> | |

| | | | |
|----------------------------------------------------------------------------------|-----------------------------------------------------------------------------------|-----------------------------------------------------------------------------------|-------------------------------------|
| Quartier | by Claesson Koivisto Rune | Ottoman | Removable fabric and leather covers |
|  |  |  | |
| <p>OQUAR46 W 46 D 46 H 46 cm Seat H 46 cm</p> | | | |
| <p>OQUAR62 W 62 D 62 H 38 cm Seat H 38 cm</p> | | | |
| <p>OQUAR112 W 112 D 112 H 33 cm Seat H 33 cm</p> | | | |



| | | | |
|------------------------------------------------------------------------------------|-------------------------------------------------------------------------------------|-------------------------------------------------------------------------------------|-------------------------------------------------------|
| Spin | by Claesson Koivisto Rune | Ottoman | Non-removable covers Not feasible in vinyl and COM |
|  |  |  | |
| <p>OSPIN60 Ø 60 H 39 cm Seat H 39 cm</p> | | | |
| <p>OSPIN90 Ø 90 H 39 cm Seat H 39 cm</p> | | | |
| <p>OSPIN117 Ø 119 H 39 cm Seat H 39 cm</p> | | | |

| | | | | |
|-------------------------------------------------------------------------------------|-------------------------------------------------------------------------------------|-------------------------------------------------------------------------------------|---------------------------------------------------------------------------------------|---------------------------------------------------------------------------------------|
|  |  |  |  |  |
| <p>Cuciture Stitches Nähte Coutures</p> | | | | |
| <p>Bianco White Weiss Blanc</p> | | | | |
| <p>Beige Beige Beige Beige</p> | | | | |
| <p>Rosso Red Rot Rouge</p> | | | | |
| <p>Blu Blue Blau Bleu</p> | | | | |
| <p>Nero Black Schwarz Noir</p> | | | | |





| | | | |
|-------------------------------------------------------------------------------------|--------------------|---------------|-------------------------------------------------------|
| Atoll | by Patrick Norguet | Chaise-longue | Non-removable covers Not feasible in vinyl and COM |
|  | | | |
| <p>OATOL85 W 85,5 D 170 H 94 cm Seat H 24,5 cm</p> | | | |











| | | | |
|-------------------------------------------------------------------------------------|-------------------------------------------------------------------------------------|---------------|----------------------|
| Slalom | by Pietro Arosio | Chaise-longue | Non-removable covers |
|  |  | | |
| <p>OSLA56 W 56 D 160 H 98 cm</p> | | | |
| <p>W 56 D 168 H 78 cm</p> | | | |



| | | | |
|-------------------------------------------------------------------------------------|-----|---------------------------------------------------------------------------------|--|
|  | T24 | | |
| <p>Base Base Gestell Piétement</p> | | <p>Cromo Satinato Satin Chrome Satinert Verchromt Chrome Satiné</p> | |

| | | | | |
|---------------------------------------------------------------------------------------|---------------------------------------------------------------------------------------|--------|------------------|------------------|
| Babela | by Achille + Pier Giacomo Castiglioni | Chairs | → Design Classic | Removable covers |
|  |  | | | |
| <p>OBAB56 W 56 D 59 H 80 cm Seat H 49 cm</p> | | | | |

| | | | | |
|---------------------------------------------------------------------------------------|---------------------------------------------------------------------------------------|---------------------------------------------------------------------------------------|---------------------------------------------------------------------------------------|---------------------------------------------------------------------------------------|
|  |  |  |  |  |
| T43 | T45 | T46 | T47 | T48 |
| <p>Base Base Gestell Piétement</p> | | | | |
| <p>Noce Scuro Dark Walnut Dunkel Walnuss Noyer Foncé</p> | | | | |
| <p>Naturale Natural Natural Naturel</p> | | | | |
| <p>Tinto Bianco White Weiss Blanc</p> | | | | |
| <p>Tinto Nero Black Schwarz Noir</p> | | | | |
| <p>Tinto Grigio Grey Grau Gris</p> | | | | |

| Doodle | by Claesson Koivisto Rune | | Chair, Armchair, Chaise-longue, Stool | | Non-removable covers Not feasible in vinyl and COM | | | |
|----------------------------------------------------------------------------------|-------------------------------------------------------------------------------------|---------------------------------------------------------------------------------------|-------------------------------------------------------------------------------------|---------------------------------------------------------------------------------------|---------------------------------------------------------------------------------------|---------------------------------------------------------------------------------------|---------------------------------------------------------------------------------------|----------------------------------|
|  |  |  |  |  | | | | |
| ODOB87 W 87 D 78 H 77 cm Seat H 41 cm | ODOA51 W 51 D 57 H 80 cm Seat H 45 cm | ODOAG51 W 51 D 57 H 80 cm Seat H 45 cm | ODOB51 W 51 D 60 H 91 cm Seat H 45 cm | ODOBG51 W 51 D 60 H 91 cm Seat H 45 cm | | | | |
|  |  |  | | | | | | |
| ODOC62 W 62 D 59 H 85 cm Seat H 46 cm | ODOCG62 W 62 D 59 H 85 cm Seat H 46 cm | ODOS49 W 49 D 53 H 100 cm Seat H 76 cm | | | | | | |
| |  |  |  |  | | | | |
| | T02 RAL 9016 | T07 RAL 9011 | T08 RAL 8019 | T93 | | | | |
| Base verniciata Painted base Gestell lackiert Piétement laqué | Bianco White Weiss Blanc | Nero Black Schwarz Noir | Marrone Brown Braun Brun | Metalgrey Metalgrey Metalgrey Metalgrey | | | | |
| |  |  |  |  |  |  |  | |
| | T24 | T25 (Only for ODOB87) | | | | | | |
| Base cromata Chromed base Gestell verchromt Piétement chromé | Cromo Satinato Satin Chromed Satinert Verchromt Chrome Satiné | Oro Champagne Opaco Matt Champagne Gold Matt Champagne Gold Or Champagne Mat | Cuciture Stitches Nähte Coutures | Bianco White Weiss Blanc | Beige Beige Beige Beige | Rosso Red Rot Rouge | Blu Blue Blau Bleu | Nero Black Schwarz Noir |

| Eddy | by PearsonLloyd | | Chair | Non-removable covers | |
|-------------------------------------------------------------------------------------|---------------------------------------------------------------------------------------|----------------------------------------------------------------------------------------|---------------------------------------------------------------------------------------|---------------------------------------------------------------------------------------|---------------------------------------------------------------------------------------|
|  | | | | | |
| OEDP61/OEDB61 W 61 D 62 H 78 cm Seat H 45 cm | Piedini Feet | | | | |
| | Piedini (OEDP61) o base girevole (OEDB61) Feet (OEDP61) or swivel base (OEDB61) | Füßen (OEDP61) oder Drehgestell (OEDB61) Patins (OEDP61) ou base pivotante (OEDB61) | | | |
| |  |  | | | |
| Cerniera Zip Reißverschluss Fermeture éclair | Bianco White Weiss Blanc | Nero Black Schwarz Noir | | | |
| Fixie | by PearsonLloyd | | Stool | Non-removable covers | |
|  | | | | | |
| OFIX37 W 37 D 37 H 68/80 cm | | | | | |
| |  |  |  |  |  |
| | T02 RAL 9016 | T06 RAL 7043 | T07 RAL 9011 | T09 RAL 1003 | T10 RAL 2004 |
| Base verniciata Painted base Gestell lackiert Piétement laqué | Bianco White Weiss Blanc | Grigio Grey Grau Gris | Nero Black Schwarz Noir | Giallo Yellow Gelb Jaune | Arancio Orange Orange Orange |
| |  |  | | | |
| | T12 RAL 3000 | T14 RAL 6018 | | | |
| Rosso Red Rot Rouge | | Verde Green Grün Vert | | | |

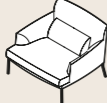
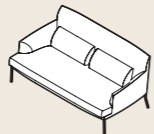
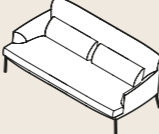
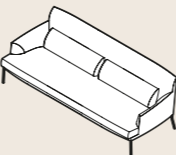
| | | | | | |
|----------------------------------------------------------------------------------|-----------------------------------------------------------------------------------|-----------------------------------------------------------------------------------|-----------------------------------------------------------------------------------|-------------------------------------------------------------------------------------|-------------------------------------------------------------------------------------|
| Montevideo | by Claesson Koivisto Rune | | Sofa, Armchair, Ottoman, Chair | | Removable covers |
|  |  |  |  |  |  |
| OMON54 W 54 D 62 H 80 cm Seat H 47 cm | OMON93 W 93 D 71 H 40 cm Seat H 40 cm | OMON96 W 96 D 90 H 78 cm Seat H 40 cm | OMON162 W 162 D 90 H 78 cm Seat H 40 cm | OMON192 W 192 D 90 H 78 cm Seat H 40 cm | OMON222 W 222 D 90 H 78 cm Seat H 40 cm |

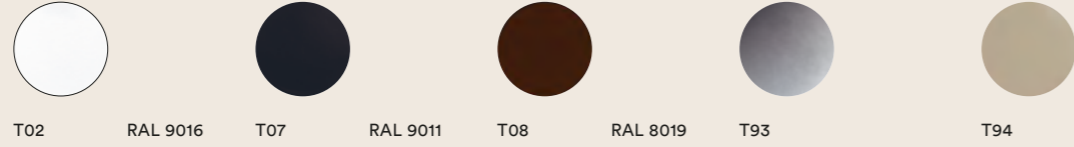

| | | | | | |
|------------------------------------------------------------------------|-----------------------------------|----------------------------------|-----------------------------------|--------------------------------------------------|--------------------------------------|
| Base verniciata Painted base Gestell lackiert Piétement laqué | Bianco White Weiss Blanc | Nero Black Schwarz Noir | Marrone Brown Braun Brun | Metalgrey Metalgrey Metalgrey Metalgrey | Bronzo Bronze Bronze Bronze |
|------------------------------------------------------------------------|-----------------------------------|----------------------------------|-----------------------------------|--------------------------------------------------|--------------------------------------|

| | | | |
|---------|--------|-------|----------------------|
| T-Chair | by B/M | Chair | Non-removable covers |
|---------|--------|-------|----------------------|



OTVT48/OTVL48
W 48 D 55 H 82 cm
Seat H 47 cm



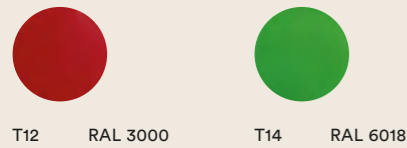

| | | | | | |
|------------------------------------------------------------------------|-----------------------------------|--------------------------------|----------------------------------|-----------------------------------|---------------------------------------|
| Base verniciata Painted base Gestell lackiert Piétement laqué | Bianco White Weiss Blanc | Grigio Grey Grau Gris | Nero Black Schwarz Noir | Giallo Yellow Gelb Jaune | Arancio Orange Orange Orange |
|------------------------------------------------------------------------|-----------------------------------|--------------------------------|----------------------------------|-----------------------------------|---------------------------------------|

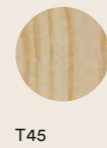

| | | |
|------------------------------|--------------------------------|---------------------------------------------------------------|
| Rosso Red Rot Rouge | Verde Green Grün Vert | Sedia in legno Wooden chair Holzstuhl Chaise en bois |
|------------------------------|--------------------------------|---------------------------------------------------------------|

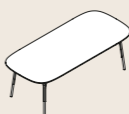
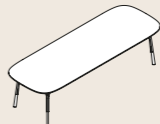

T45
Naturale
Natural
Naturel

| | | | |
|-------------------------------------------------------------------------------------|-------------------------------------------------------------------------------------|-------------------------------------------------------------------------------------|-------------------------------------------------------------------------------------|
| Kelly T | by Claesson Koivisto Rune | | Table |
|  |  |  |  |
| 1KELT99 W 99 D 99 H 72 cm | 1KELT120 W 120 D 120 H 72 cm | 1KELT220 W 220 D 99 H 72 cm | 1KELT2809 W 280 D 99 H 72 cm |



| | | | | | |
|------------------------------------------------------------------------|-----------------------------------|--------------------------------|----------------------------------------|----------------------------------|-----------------------------------|
| Base verniciata Painted base Gestell lackiert Piétement laqué | Bianco White Weiss Blanc | Grigio Grey Grau Gris | Grigio Cemento Grey Grau Gris | Nero Black Schwarz Noir | Giallo Yellow Gelb Jaune |
|------------------------------------------------------------------------|-----------------------------------|--------------------------------|----------------------------------------|----------------------------------|-----------------------------------|

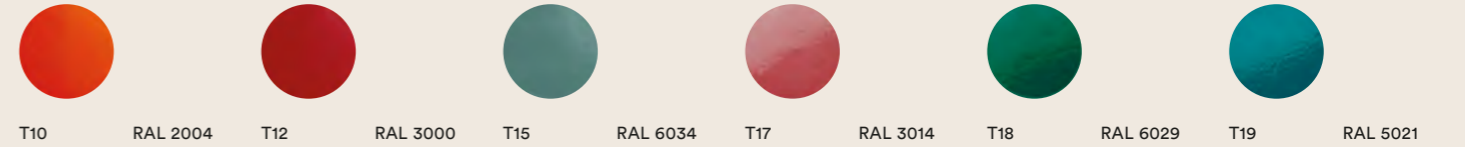

| | | | | | |
|---------------------------------------|------------------------------|----------------------------------------------|------------------------------|--------------------------------|---------------------------------------------------------------|
| Arancio Orange Orange Orange | Rosso Red Rot Rouge | Turchese Turquoise Türkis Turquoise | Rosa Pink Rosa Rose | Verde Green Grün Vert | Blu Petrolio Petrol Blue Petroleum Blau Bleu Pétrole |
|---------------------------------------|------------------------------|----------------------------------------------|------------------------------|--------------------------------|---------------------------------------------------------------|

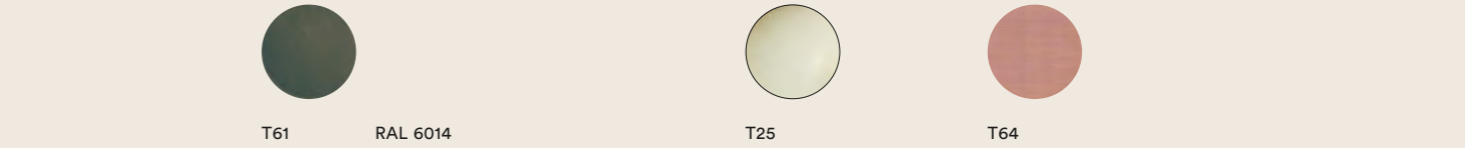

| | | | | |
|------------------------------------------------------------------------|-------------------------------------------------------|-----------------------------------------------------------------------|---------------------------------------------------------------------------------------|------------------------------------------------------------------------------------------|
| Base verniciata Painted base Gestell lackiert Piétement laqué | Verde Scuro Dark Green Dunkelgrün Vert Foncé | Base cromata Chromed base Gestell verchromt Piétement chromé | Oro Champagne Opaco Matt Champagne Gold Matt Champagne Gold Or Champagne Mat | Rame Spazzolato Opaco Brush Matt Copper Matt Gebürstet Kupfer Brossé Mat Cuivre |
|------------------------------------------------------------------------|-------------------------------------------------------|-----------------------------------------------------------------------|---------------------------------------------------------------------------------------|------------------------------------------------------------------------------------------|

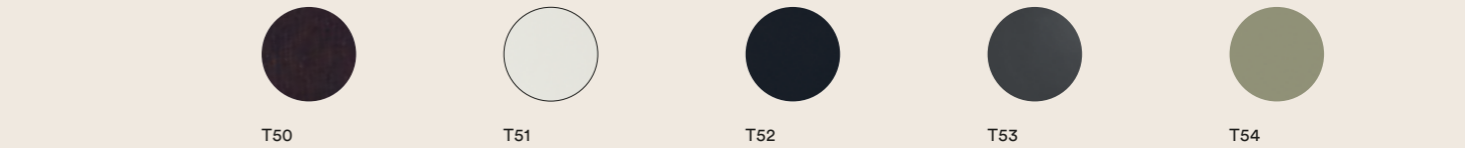









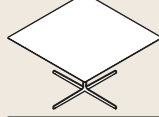
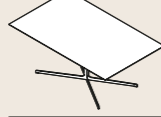

| | | | | | |
|----------------------------------------|----------------------------------|-----------------------------------|----------------------------------|--------------------------------|----------------------------------------|
| Piano Top Tischplatte Plateau | Wengè Wengè Wengè Wengè | Bianco White Weiss Blanc | Nero Black Schwarz Noir | Grigio Grey Grau Gris | Grigio Cemento Grey Grau Gris |
|----------------------------------------|----------------------------------|-----------------------------------|----------------------------------|--------------------------------|----------------------------------------|



| | | | | |
|------------------------------|----------------------------------------------|---------------------------------------------------|-----------------------------------------------------------------------|--------------------------------------|
| Rosa Pink Rosa Rose | Turchese Turquoise Türkis Turquoise | Finiture Finishes Vollendungen Finitions | Goffrato Embossed finish Geprägte Oberfläche Finiture Gaufré | Velvet Velvet Velvet Velvet |
|------------------------------|----------------------------------------------|---------------------------------------------------|-----------------------------------------------------------------------|--------------------------------------|

| | | | | | |
|-------------------------------------------------------------------------------------|-----------------------------------------------------------------------------------|----------------------------------------------|---------------------------------------------------|-----------------------------------------------------------------------|--------------------------------------|
| Kelly T | | by Claesson Koivisto Rune | | Table | |
|  |  | | | | |
| 1KELTC85 Ø 85 H 72 cm | 1KELTC80X80 W 80 D 80 H 72 cm | | | | |
|  | | | | | |
| T02 | RAL 9016 | T03 | RAL 7016 | T05 | RAL 7023 |
| T07 | RAL 9011 | T08 | RAL 8019 | | |
| Base verniciata Painted base Gestell lackiert Piétement laqué | Bianco White Weiss Blanc | Grigio Grey Gru Gris | Grigio cemento Grey Gru Gris | Nero Black Schwarz Noir | Marrone Brown Braun Brun |
|  | | | | | |
| T09 | RAL 1003 | T10 | RAL 2004 | T12 | RAL 3000 |
| T15 | RAL 6034 | T17 | RAL 3014 | T18 | RAL 6029 |
| Giallo Yellow Gelb Jaune | Arancio Orange Orange Orange | Rosso Red Rot Rouge | Turchese Turquoise Türkis Turquoise | Rosa Pink Rosa Rose | Verde Green Grün Vert |
|  | | | | | |
| T19 | RAL 5021 | T61 | RAL 6014 | T51 | |
| T52 | | T53 | | | |
| Blu Petrolio Petrol Blue Petroleum Blau Bleu Pétrole | Verde Scuro Dark Green Dunkelgrün Vert Foncé | Piano Top Tischplatte Plateau | Bianco White Weiss Blanc | Nero Black Schwarz Noir | Grigio Grey Gru Gris |
|  | | | | | |
| T54 | T55 | T56 | TA | TB | |
| Grigio Cemento Grey Gru Gris | Rosa Pink Rosa Rose | Turchese Turquoise Türkis Turquoise | Finiture Finishes Vollendungen Finitions | Goffrato Embossed finish Geprägte Oberfläche Finiture Gaufré | Velvet Velvet Velvet Velvet |

| | | | | | |
|---------------------------------------------------------------------------------------|-------------------------------------------------------------------------------------------------------|---------------------------------------------------------------------------------------------------|---------------------------------------------------------------------------------------------------|---------------------------------------------------------------------------------------|---------------------------------------------------------------------------------------|
| Spindle | | by Gordon Guillaumier | | Table | |
|  |  |  |  |  |  |
| 1SPI90Q W 90 D 90 H 73 cm | 1SPI145Q W 145 D 145 H 73 cm | 1SPI145 W 145 D 70 H 73 cm | 1SPI185 W 185 D 95 H 73 cm | 1SPI240 W 240 D 95 H 73 cm | Impilabile Stackable |
|  | | | | | |
| T38 | | T39 | T40 | T41 | T43 |
| Piano Top Tischplatte Plateau | Vetro Retroverniciato Bianco White Rear Painted Glass Weiss Lackiert Glas Verre Lacqué Blanc | Vetro Retroverniciato Grigio Grey Rear Painted Glass Gru Lackiert Glas Verre Lacqué Gris | Vetro Retroverniciato Blu Blue Rear Painted Glass Blau Lackiert Glas Verre Lacqué Bleu | Specchio Fumé Smoked Mirror Geräucherte Spiegel Miroir Fumé | Noce Scuro Dark Walnut Dunkel Walnut Noyer Foncé |
|  | | | | | |
| T49 | | T02 | RAL 9016 | T03 | RAL 7016 |
| T11 | RAL 2011 | T19 | RAL 5021 | | |
| Tinto Grigio Grey Gru Gris | Base verniciata Painted base Gestell lackiert Piétement laqué | Bianco White Weiss Blanc | Grigio Grey Gru Gris | Arancio Orange Orange Orange | Blu Petrolio Petrol Blue Petroleum Blau Bleu Pétrole |
| Split | | by Claesson Koivisto Rune | | Table, Low Table | |
|  |  |  |  |  |  |
| LOW TABLE 1SPLI53 Ø 53 H 50 cm | LOW TABLE 1SPLI45 W 45 D 45 H 50 cm | HIGH TABLE 1SPLI70 Ø 70 H 72 cm | HIGH TABLE 1SPLI65 W 65 D 65 H 72 cm | HIGH TABLE 1SPLI53A Ø 53 H 110 cm | HIGH TABLE 1SPLIQ53A W 53 D 53 H 110 cm |
|  | | | | | |
| Base verniciata Painted base Gestell lackiert Piétement laqué | | T02 | RAL 9016 | T07 | RAL 9011 |
| | | T08 | RAL 8019 | T93 | |
| | | T94 | | | |
| | | Bianco White Weiss Blanc | Nero Black Schwarz Noir | Marrone Brown Braun Brun | Metalgrey Metalgrey Metalgrey Metalgrey |
| | | Bronzo Bronze Bronze Bronze | | | |
|  | | | | | |
| Piano Top Tischplatte Plateau | | T29 | T33 | T57 | T58 |
| | | Carrara Lucido Shiny White Carrara Carrara Glänzend Carrara Brillant | Black Travertino Opaco Matt Black Travertine Matt Schwarz Travertino Noir Travertino Mat | Full Color Bianco White Full Color Weiß Full color Full Color Blanc | Full Color Nero Black Full Color Schwarz Full Color Full Color Noir |

| Split | by Claesson Koivisto Rune | | Table, Low Table | | |
|----------------------------------------------------------------------------------|-----------------------------------------------------------------------------------|-----------------------------------------------------------------------------------|-----------------------------------------------------------------------------------|-------------------------------------------------------------------------------------|-------------------------------------------------------------------------------------|
|  |  |  |  | | |
| 1SPLI130 Ø 127 H 72 cm | 1SPLI120 W 120 D 120 H 72 cm | 1SPLI180 W 180 D 110 H 72 cm | 1SPLI220 W 220 D 120 H 72 cm | | |
| |  |  |  |  |  |
| | T02 RAL 9016 | T07 RAL 9011 | T08 RAL 8019 | T93 | T94 |
| Base verniciata Painted base Gestell lackiert Piétement laqué | Bianco White Weiss Blanc | Nero Black Schwarz Noir | Marrone Brown Braun Brun | Metalgrey Metalgrey Metalgrey Metalgrey | Bronzo Bronze Bronze Bronze |
|  | |  |  |  |  |
| T112 | | T51 | T52 | T109 | T110 |
| Sabbia Sand Sand Sable | Piano Top Tischplatte Plateau | Bianco White Weiss Blanc | Nero Black Schwarz Noir | Lava Lava Lava Lave | Sabbia Sand Sand Sable |

| Coot | by Gordon Guillaumier | | Low Table | | |
|------------------------------------------------------------------------------------|-------------------------------------------------------------------------------------|---------------------------------------------------------------------------------------|-------------------------------------------------------------------------------------------------------|---------------------------------------------------------------------------------------|---------------------------------------------------------------------------------------|
|  | | | | | |
| 1COOT50 W 50 D 50 H 48,5 cm | | | | | |
| |  |  | | | |
| | T01 RAL 9010 | T07 RAL 9011 | | | |
| Base verniciata Painted base Gestell lackiert Piétement laqué | Bianco White Weiss Blanc | Nero Black Schwarz Noir | | | |
| |  |  |  |  |  |
| | T29 | T31 | T32 | T59 | T60 |
| Piano Top Tischplatte Plateau | Carrara Lucido Shiny White Carrara Carrara Glänzend Carrara Brillant | Calacatta Lucido Shiny White Calacatta Calacatta Glänzend Calacatta Brillant | Marquinia Lucido Shiny Black Marquinia Schwarz Marquinia Glänzend Noir Marquinia Brillant | Laminato Bianco White Laminat Laminat Weiß Blanc Laminé | Laminato Nero Black Laminat Laminat Schwarz Noir Laminé |

| Cage | by Gordon Guillaumier | | Low Table | | |
|-------------------------------------------------------------------------------------|---------------------------------------------------------------------------------------|-----------------------------------------------------------------------------------------------------|-------------------------------------------------------------------------------------------------------|---------------------------------------------------------------------------------------------------|---------------------------------------------------------------------------------------------|
|  |  |  |  | | |
| 1CAGT50 Ø 50 H 47 cm | 1CAGT100 Ø 100 H 32 cm | 1CAGQ50 W 50 D 50 H 47 cm | 1CAGQ100 W 100 D 100 H 32 cm | | |
| |  |  |  |  |  |
| | T25 | T26 | T27 | T28 | T64 |
| Base cromata Chromed base Gestell verchromt Piétement chromé | Oro Champagne Opaco Matt Champagne Gold Matt Champagne Gold Or Champagne Mat | Oro Champagne Lucido Polished Champagne Gold Champagne Gold Glänzend Or Champagne Brillant | Cromo Nero Opaco Matt Black Chromed Matt Schwarz Verchromt Noir Mat | Cromo Nero Lucido Polished Black Chromed Schwarz-Glänzend Noir Brillant | Rame Spazzolato Opaco Brush Matt Copper Matt Gebürstet Kupfer Brossé Mat Cuivre |
| |  |  | | | |
| | T01 RAL 9010 | T07 RAL 9011 | | | |
| Base verniciata Painted base Gestell lackiert Piétement laqué | Bianco White Weiss Blanc | Nero Black Schwarz Noir | | | |
| |  |  |  |  |  |
| | T29 | T31 | T32 | T33 | T37 |
| Piano Top Tischplatte Plateau | Carrara Lucido Shiny White Carrara Carrara Glänzend Carrara Brillant | Calacatta Lucido Shiny White Calacatta Calacatta Glänzend Calacatta Brillant | Marquinia Lucido Shiny Black Marquinia Schwarz Marquinia Glänzend Noir Marquinia Brillant | Black Travertino Opaco Matt Black Travertine Matt Schwarz Travertino Noir Travertino Mat | Verde Guatemala Lucido Shiny Green Guatemala Guatemala Glänzend Guatemala Brillant |
| |  |  |  |  | |
| | T41 | T42 | T59 | T60 | |
| Specchio Fumé Smoked Mirror Geräucherte Spiegel Miroir Fumé | Specchio Bronzato Bronze Mirror Bronzespiegel Miroir Bronzé | Laminato Bianco White Laminat Laminat Weiß Blanc Laminé | Laminato Nero Black Laminat Laminat Schwarz Noir Laminé | | |

Labanca Table by Lievore Altherr Molina Low Table



1LABNE/1LABBI
W 66 D 66 H 36 cm

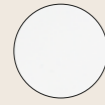

T38

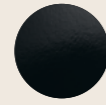

| | | |
|---------------------------------------------------|-------------------------------------------------------------------------------------------------------|-----------------------------------------------------------------------------------------------------|
| Finiture Finishes Vollendungen Finitions | Vetro Retroverniciato Bianco White Rear Painted Glass Weiss Lackiert Glas Verre Lacqué Blanc | Vetro Retroverniciato Nero Black Rear Painted Glass Schwarz Lackiert Glas Verre Laqué Noir |
|---------------------------------------------------|-------------------------------------------------------------------------------------------------------|-----------------------------------------------------------------------------------------------------|

Ledge by Gordon Guillaumier Low Table



1LEDG52
L28 D 52 H 56 cm



T02

RAL 9016



T03

RAL 7016

| | | | | | |
|------------------------------------------------------------------------|-----------------------------------|--------------------------------|-----------------------------------------------------------------------|-----------------------------------------------------------------------|---------------------------------------------------------------------------------------|
| Base verniciata Painted base Gestell lackiert Piétement laqué | Bianco White Weiss Blanc | Grigio Grey Grau Gris | Base cromata Chromed base Gestell verchromt Piétement chromé | Cromo Satinato Satin Chrome Satinert Verchromt Chrome Satiné | Oro Champagne Opaco Matt Champagne Gold Matt Champagne Gold Or Champagne Mat |
|------------------------------------------------------------------------|-----------------------------------|--------------------------------|-----------------------------------------------------------------------|-----------------------------------------------------------------------|---------------------------------------------------------------------------------------|



T64



T30



T31

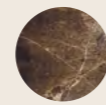

T33



T35

| | | | | | |
|------------------------------------------------------------------------------------------|----------------------------------------|--------------------------------------------------------------------|---------------------------------------------------------------------------------------|---------------------------------------------------------------------------------------------------|----------------------------------------------------------------------|
| Rame Spazzolato Opaco Brush Matt Copper Matt Gebürstet Kupfer Brossé Mat Cuivre | Piano Top Tischplatte Plateau | Carrara Opaco Matt White Carrara Matt Carrara Carrara Mat | Calacatta Lucido Shiny White Calacatta Calacatta Glänzend Calacatta Brillant | Black Travertino Opaco Matt Black Travertine Matt Schwarz Travertino Noir Travertino Mat | Basaltina Opaco Matt Basaltina Matt Basaltina Basaltina Mat |
|------------------------------------------------------------------------------------------|----------------------------------------|--------------------------------------------------------------------|---------------------------------------------------------------------------------------|---------------------------------------------------------------------------------------------------|----------------------------------------------------------------------|

Nara by Lievore Altherr Molina Low Table



1NAR70
W 70 D 70 H 30 cm

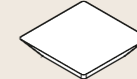

1NAR109
W 109 D 109 H 25 cm



1NAR80R
Ø 80 H 36 cm



1NAR110R
Ø 110 H 26 cm



| | | | |
|--------------------------------------------------------|-----------------------------------|----------------------------------|----------------------------------------------------------|
| Rivestimento Upholstery Polsterung Tapisserie | Bianco White Weiss Blanc | Nero Black Schwarz Noir | Testa di Moro Dark Brown Dunkelbraun Brun foncé |
|--------------------------------------------------------|-----------------------------------|----------------------------------|----------------------------------------------------------|

Polar Table by PearsonLloyd Low Table



1POLU/1POOP
W 49 D 41 H 43 cm

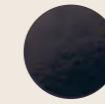

| | | | | |
|---------------------------------------------------|-----------------------------------------------------|-----------------------------------------------------------------|-----------------------------------------------------------------|------------------------------------------------------------------|
| Finiture Finishes Vollendungen Finitions | Bianco Opaco White Mat Weiß Matt Blanc Mat | Nero Lucido Gloss Black Schwarz Glänzend Noir Brillant | Bianco Lucido Gloss White Weiß Glänzend Blanc Brillant | Giallo Lucido Gloss Yellow Gelb Glänzend Jaune Brillant |
|---------------------------------------------------|-----------------------------------------------------|-----------------------------------------------------------------|-----------------------------------------------------------------|------------------------------------------------------------------|

Please specify hole position when placing order

1SOAP54
W 54 D 54 H 54 cm1SOAP130
W 130 D 62 H 35 cm

T02

RAL 9016

Base verniciata
Painted base
Gestell lackiert
Piétement laquéBianco
White
Weiss
Blanc

T03

RAL 7016

Grigio
Grey
Grau
Gris

T24

Base cromata
Chromed base
Gestell verchromt
Piétement chroméCromo Satinato
Satin Chrome
Satinier Verchromt
Chrome Satiné

T25

Oro Champagne Opaco
Matt Champagne Gold
Matt Champagne Gold
Or Champagne Mat

T64

Rame Spazzolato Opaco
Brush Matt Copper
Matt Gebürstet Kupfer
Brossé Mat Cuivre

T31

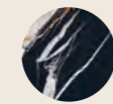
Piano
Top
Tischplatte
PlateauCalacatta Lucido
Shiny White Calacatta
Calacatta Glänzend
Calacatta Brillant

T74*

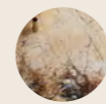
Sahara Noir Lucido
Shiny Sahara Noir
Sahara Glänzend
Sahara Brillant

T118

Patagonia Lucido
Shiny Patagonia
Patagonia Glänzend
Patagonia Brillant* Anti-stain treatment
compulsory with
top in Sahara Noir

World Project



A design cannot be considered in isolation from external constraints and stresses. This is why Tacchini maintains a dialogue so as to grasp and interpret the thoughts of its designers and of its clients. In the contract world, this enables it to express the quality of its products, using the best materials and complying with the strictest standards and certifications. Places of work or play, hotels, stadiums, wellness centres or shopping malls, all become the stage on which Tacchini can express the uniqueness of its designs, their durability, comfort and versatility. What's more, the constant relationship with the modern world and the stresses it brings makes Tacchini a veritable seismograph of the state of being: an accurate sensor and promoter of new possibilities, bringing better living for all. Anywhere, out of the world.

Un progetto non può prescindere dai vincoli e dalle sollecitazioni esterne. Per questo, Tacchini dialoga, comprende e traduce il pensiero dei progettisti e dei suoi clienti: esprimendo, nel mondo del contract, la qualità delle sue realizzazioni, attraverso l'impiego dei migliori materiali secondo le più severe normative di riferimento e certificazioni. Luoghi ludici o di lavoro, hotel, stadi, centri per il benessere o dedicati allo shopping, diventano palcoscenici sui quali Tacchini esprime l'unicità e la resistenza, il comfort e la flessibilità dei suoi progetti. Non solo, il costante rapporto con la contemporaneità e le sollecitazioni che ne derivano, rendono Tacchini un autentico sismografo dell'essere: attento recettore e propositore di nuove possibilità, per un vivere meglio tutti. Anywhere, out of the world.



02.



04.

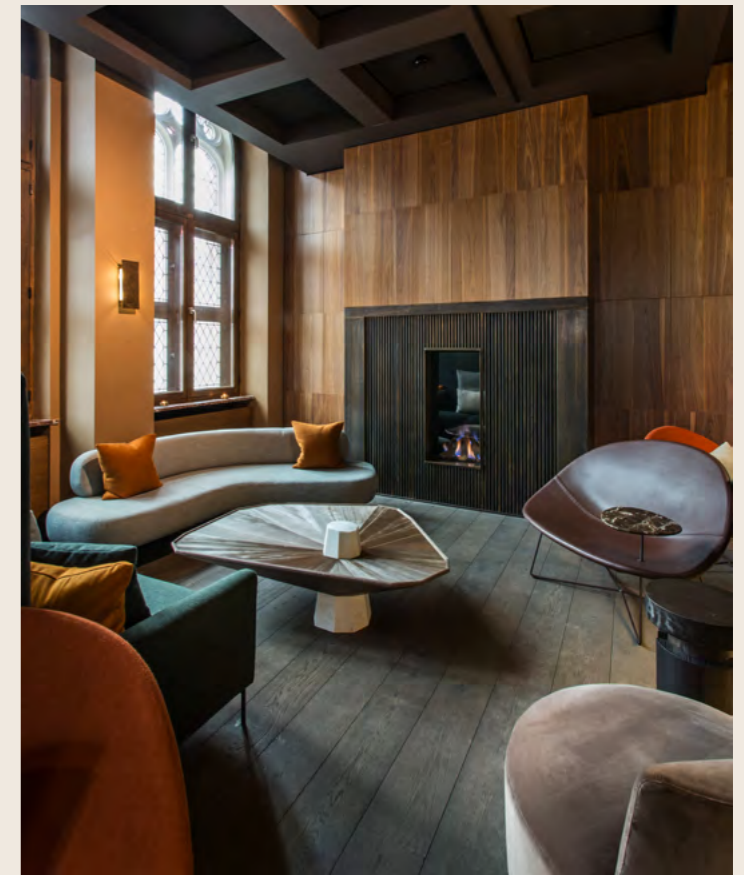

05.

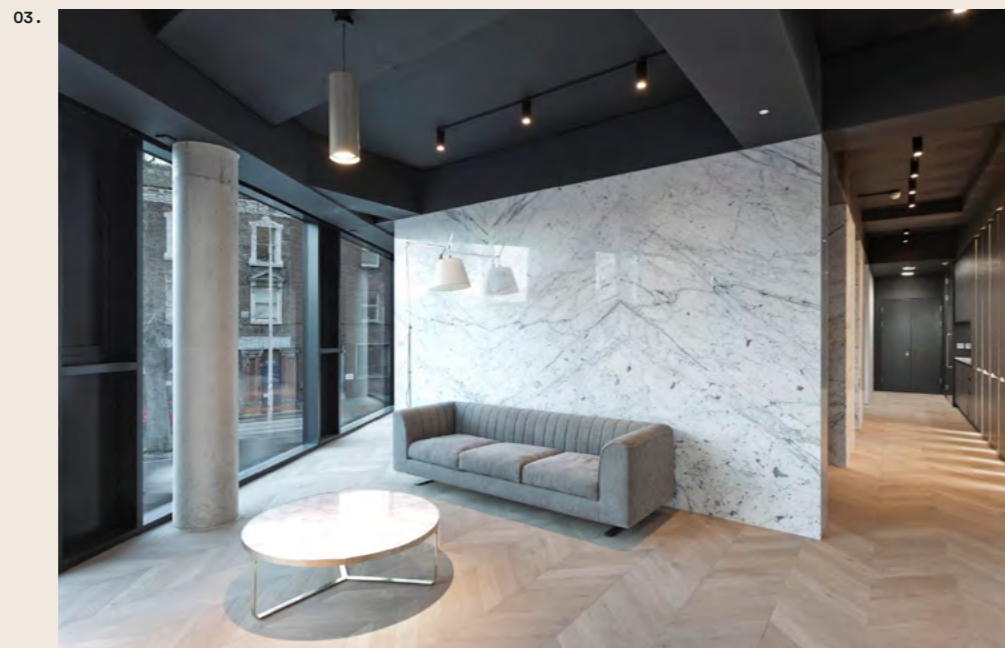

03.



06.



07.

- 01. EF Education First (Zurich, Switzerland)
- 02. Okko Hotel Gare de l'Est (Paris, France)
- 03. 55 Percy Place (Dublin, Ireland)
- 04. Zander K (Bergen, Norway)
- 05. The Fourth, Tafelrond Hotel (Leuven, Belgium)
- 06. Mirum Agency (Helsinki, Finland)
- 07. EF Education First (Eastbourne, Great Britain)



08.



09.



11.



10.



12.



13.

08. Alysi Showroom (Milan, Italy)
 09. Kurumoch International Airport (Samara, Russia)
 10. Rob Peetoom Williamsburg (New York, USA)
 11. Marktgasse Hotel (Zurich, Switzerland)
 12. The Holly Penthouse (Melbourne, Australia)
 13. Ceramika Café (Matsumoto, Japan)

Tacchini si impegna concretamente per il rispetto dell'ambiente, lo sviluppo sostenibile ed il consumo intelligente. La qualità dei materiali e della realizzazione garantisce una lunga vita dei prodotti, riducendo il consumo di energia, le emissioni in atmosfera e l'impatto ambientale al termine del loro utilizzo. W'azienda utilizza legni provenienti da coltivazioni a ricrescita controllata, privilegia l'impiego di materiali riciclabili e riduce al massimo gli sprechi in fase di produzione e imballo.

Tacchini is concretely committed to environment respect, sustainable development and clever consumption. Materials and manufacturing quality guarantees long lasting products, reducing energy consumption, emissions into the atmosphere and environmental impact when their use is over. The company uses wood from sustainable cultivations, favours recyclable materials and highly reduces waste during both production and packing steps.

Tacchini T'20
Objects, Stories

Graphic design:
Think Work Observe

Photography:
Andrea Ferrari

Styling:
Maria Gabriella Zecca

Copy editing:
Gaia De Santis
Massimiliano
Di Bartolomeo

Post production:
Erica Fadini

Color separation
and printing:
Nava

Copyright © 2020 Tacchini
Italia Forniture Srl
All rights reserved. No part
of this publication may be
reproduced or transmitted in
any form or by any means,
electronic or mechanical,
without prior permission of
the owner. All copyrights and
intellectual property rights,
including trademarks, patents
and copyrights, remain the
property of Tacchini Italia
Forniture Srl and are explicitly
reserved.

Acknowledgments:
Artemide
Astep
Bitossi Home
cc tapis
Flos
Fontana Arte
Ghidini 1961
Incipit Lab
Martinelli Luce
Nemo Lighting
Nodus
Orsjo
Penta Light
Stelton
Wastberg
Zero Lighting

Tacchini Italia Forniture Srl

19, via Domodossola
20822 Baruccana di Seveso
(Monza Brianza) Italy
T: +39 0362 50 41 82
E-mail: info@tacchini.it
www.tacchini.it

